



# GTN 725/750

Pilot's Guide

Map



Traffic



Terrain



Weather



Charts



Flight Plan



Procedures



Nearest



Waypoint Info



Music



Utilities



System



© 2011 Garmin Ltd. or its subsidiaries. All rights reserved.

This manual reflects the operation of System Software version 2.00, or later. Some differences in operation may be observed when comparing the information in this manual to later software versions.

Garmin International, Inc., 1200 East 151st Street, Olathe, KS 66062, U.S.A.

Tel: 913/397.8200

Fax: 913/397.8282

Garmin AT, Inc., 2345 Turner Road SE, Salem, OR 97302, U.S.A.

Tel: 503/391.3411

Fax 503/364.2138

Garmin (Europe) Ltd., Liberty House, Bulls Copse Road, Hounslow Business Park, Southampton, SO40 9RB, U.K.

Tel. +44 (0) 870 850 1243

Fax +44 (0) 238 052 4004

Garmin Corporation, No. 68, Jangshu 2nd Road, Shijr, Taipei County, Taiwan

Tel: 886/02.2642.9199

Fax: 886/02.2642.9099

Garmin Singapore Pte. Ltd., 46 East Coast Road, #05-06 Eastgate, Singapore 428766

Tel : (65) 63480378

Fax : ( 65 ) 63480278

At Garmin, we value your opinion. For comments about this guide, please e-mail:

Techpubs.Salem@Garmin.com

[www.garmin.com](http://www.garmin.com)

Except as expressly provided herein, no part of this manual may be reproduced, copied, transmitted, disseminated, downloaded or stored in any storage medium, for any purpose without the express written permission of Garmin. Garmin hereby grants permission to download a single copy of this manual and of any revision to this manual onto a hard drive or other electronic storage medium to be viewed for personal use, provided that such electronic or printed copy of this manual or revision must contain the complete text of this copyright notice and provided further that any unauthorized commercial distribution of this manual or any revision hereto is strictly prohibited.

Garmin®, FliteCharts®, and SafeTaxi® are registered trademarks of Garmin Ltd. or its subsidiaries. Garmin SVT™ is a trademark of Garmin Ltd. or its subsidiaries. These trademarks may not be used without the express permission of Garmin.

NavData® is a registered trademark of Jeppesen, Inc.; StormScope® and SkyWatch® are registered trademarks of L-3 Communications; and XM® is a registered trademark of XM Satellite Radio, Inc.; Iridium® is a registered trademark of Iridium Communications Inc.; Canadian radar data provided by Environment Canada; United States radar data provided by NOAA; European radar data collected and provided by Meteo France.

## LIMITED WARRANTY

All Garmin avionics products are warranted to be free from defects in materials or workmanship for: two years from the date of purchase for new Remote-Mount and Panel-Mount products; one year from the date of purchase for new portable products and any purchased newly-overhauled products; six months for newly-overhauled products exchanged through a Garmin Authorized Service Center; and 90 days for factory repaired or newly-overhauled products exchanged at Garmin in lieu of repair. Within the applicable period, Garmin will, at its sole option, repair or replace any components that fail in normal use. Such repairs or replacement will be made at no charge to the customer for parts or labor, provided that the customer shall be responsible for any transportation cost. This warranty does not apply to: (i) cosmetic damage, such as scratches, nicks and dents; (ii) consumable parts, such as batteries, unless product damage has occurred due to a defect in materials or workmanship; (iii) damage caused by accident, abuse, misuse, water, flood, fire, or other acts of nature or external causes; (iv) damage caused by service performed by anyone who is not an authorized service provider of Garmin; or (v) damage to a product that has been modified or altered without the written permission of Garmin. In addition, Garmin reserves the right to refuse warranty claims against products or services that are obtained and/or used in contravention of the laws of any country.

THE WARRANTIES AND REMEDIES CONTAINED HEREIN ARE EXCLUSIVE AND IN LIEU OF ALL OTHER WARRANTIES, WHETHER EXPRESS, IMPLIED OR STATUTORY, INCLUDING ANY LIABILITY ARISING UNDER ANY WARRANTY OF MERCHANTABILITY OR FITNESS FOR A PARTICULAR PURPOSE, STATUTORY OR OTHERWISE. THIS WARRANTY GIVES YOU SPECIFIC LEGAL RIGHTS, WHICH MAY VARY FROM STATE TO STATE.

IN NO EVENT SHALL GARMIN BE LIABLE FOR ANY INCIDENTAL, SPECIAL, INDIRECT OR CONSEQUENTIAL DAMAGES, WHETHER RESULTING FROM THE USE, MISUSE OR INABILITY TO USE THE PRODUCT OR FROM DEFECTS IN THE PRODUCT. SOME STATES DO NOT ALLOW THE EXCLUSION OF INCIDENTAL OR CONSEQUENTIAL DAMAGES, SO THE ABOVE LIMITATIONS MAY NOT APPLY TO YOU.

Garmin retains the exclusive right to repair or replace (with a new or newly-overhauled replacement product) the product or software or offer a full refund of the purchase price at its sole discretion. SUCH REMEDY SHALL BE YOUR SOLE AND EXCLUSIVE REMEDY FOR ANY BREACH OF WARRANTY.

**Online Auction Purchases:** Products purchased through online auctions are not eligible for warranty coverage. Online auction confirmations are not accepted for warranty verification. To obtain warranty service, an original or copy of the sales receipt from the original retailer is required. Garmin will not replace missing components from any package purchased through an online auction.

**International Purchases:** A separate warranty may be provided by international distributors for devices purchased outside the United States depending on the country. If applicable, this warranty is provided by the local in-country distributor and this distributor provides local service for your device. Distributor warranties are only valid in the area of intended distribution. Devices purchased in the United States or Canada must be returned to the Garmin service center in the United Kingdom, the United States, Canada, or Taiwan for service.

To obtain warranty service, contact your local Garmin Authorized Service Center. For assistance in locating a Service Center near you, visit the Garmin web site at <http://www.garmin.com> or contact Garmin Customer Service at 800-800-1020.

Foreword



---

**WARNING:** *Navigation and terrain separation must NOT be predicated upon the use of the terrain function. The GTN 725/750 Terrain Proximity feature is NOT intended to be used as a primary reference for terrain avoidance and does not relieve the pilot from the responsibility of being aware of surroundings during flight. The Terrain Proximity feature is only to be used as an aid for terrain avoidance and is not certified for use in applications requiring a certified terrain awareness system. Terrain data is obtained from third party sources. Garmin is not able to independently verify the accuracy of the terrain data.*

---

Getting Started

Audio & Xpdr Ctrl

Com/Nav

FPL

Direct-To



---

**WARNING:** *The displayed minimum safe altitudes (MSAs) are only advisory in nature and should not be relied upon as the sole source of obstacle and terrain avoidance information. Always refer to current aeronautical charts for appropriate minimum clearance altitudes.*

---

Proc

Charts



---

**WARNING:** *The Garmin GTN 725/750 has a very high degree of functional integrity. However, the pilot must recognize that providing monitoring and/or self-test capability for all conceivable system failures is not practical. Although unlikely, it may be possible for erroneous operation to occur without a fault indication shown by the GTN 725/750. It is thus the responsibility of the pilot to detect such an occurrence by means of cross-checking with all redundant or correlated information available in the cockpit.*

---

Wpt Info

Map

Traffic

Terrain



---

**WARNING:** *The altitude calculated by GPS receivers is geometric height above Mean Sea Level and could vary significantly from the altitude displayed by pressure altimeters, such as the output from the GDC 74A/B Air Data Computer, or other altimeters in aircraft. GPS altitude should never be used for vertical navigation. Always use pressure altitude displayed by pressure altimeters in the aircraft.*

---

Weather

Nearest

Music



---

**WARNING:** *Do not use outdated database information. Databases used in the GTN 725/750 system must be updated regularly in order to ensure that the information remains current. Pilots using an outdated database do so entirely at their own risk.*

---

Utilities

System

Messages



---

**WARNING:** *Do not use basemap (land and water data) information for primary navigation. Basemap data is intended only to supplement other approved navigation data sources and should be considered as an aid to enhance situational awareness.*

---

Symbols

Appendix

Index



**WARNING:** Traffic information shown on the GTN 725/750 is provided as an aid in visually acquiring traffic. Pilots must maneuver the aircraft based only upon ATC guidance or positive visual acquisition of conflicting traffic.



**WARNING:** Datalink weather should not be used for hazardous weather penetration. Weather information provided by the GDL 69/69A is approved only for weather avoidance, not penetration.



**WARNING:** Datalink weather data is to be used for long-range planning purposes only. Due to inherent delays in data transmission and the relative age of the data, datalink weather data should not be used for short-range weather avoidance.



**WARNING:** For safety reasons, GTN 725/750 operational procedures must be learned on the ground.



**WARNING:** To reduce the risk of unsafe operation, carefully review and understand all aspects of the GTN 725/750 Pilot's Guide. Thoroughly practice basic operation prior to actual use. During flight operations, carefully compare indications from the GTN 725/750 to all available navigation sources, including the information from other NAVAIDs, visual sightings, charts, etc. For safety purposes, always resolve any discrepancies before continuing navigation.



**WARNING:** Never use the datalink weather to attempt to penetrate a thunderstorm. Both the FAA Advisory Circular, Subject: Thunderstorms, and the Airman's Information Manual (AIM) recommend avoiding "by at least 20 miles any thunderstorm identified as severe or giving an intense radar echo."



**CAUTION:** The United States government operates the Global Positioning System and is solely responsible for its accuracy and maintenance. The GPS system is subject to changes which could affect the accuracy and performance of all GPS equipment. Portions of the Garmin GTN 725/750 utilize GPS as a precision electronic NAVigation AID (NAVAID). Therefore, as with all NAVAIDs, information presented by the GTN 725/750 can be misused or misinterpreted and, therefore, become unsafe.

Foreword



**CAUTION:** The Garmin GTN 725/750 does not contain any user-serviceable parts. Repairs should only be made by an authorized Garmin service center. Unauthorized repairs or modifications could void both the warranty and the pilot's authority to operate this device under FAA/FCC regulations.

Getting Started

Audio & Xpdr Ctrl



**CAUTION:** The GTN displays use a lens coated with a special anti-reflective coating that is very sensitive to skin oils, waxes, and abrasive cleaners. **CLEANERS CONTAINING AMMONIA WILL HARM THE ANTI-REFLECTIVE COATING.** It is very important to clean the lens using a clean, lint-free cloth and an eyeglass lens cleaner that is specified as safe for anti-reflective coatings.

Com/Nav

FPL

Direct-To



**CAUTION:** Garmin would like to remind pilots flying with GDL 69/69A-equipped aircraft that TFRs are only advisory and are not a replacement for a thorough preflight briefing on TFR times and locations. Always confirm TFR data through official sources and contact your Flight Service Station for interpretation of TFR data.

Proc

Charts

Wpt Info



**NOTE:** All visual depictions contained within this document, including screen images of the GTN bezel and displays, are subject to change and may not reflect the most current GTN software. Depictions of equipment may differ slightly from the actual equipment.

Map

Traffic



**NOTE:** This device complies with part 15 of the FCC Rules. Operation is subject to the following two conditions: (1) this device may not cause harmful interference, and (2) this device must accept any interference received, including interference that may cause undesired operation.

Terrain

Weather



**NOTE:** Terrain data is not displayed when the aircraft latitude is greater than 75° North or 60° South.

Nearest

Music



**NOTE:** This product, its packaging, and its components contain chemicals known to the State of California to cause cancer, birth defects, or reproductive harm. This notice is being provided in accordance with California's Proposition 65. If you have any questions or would like additional information, please refer to our web site at [www.garmin.com/prop65](http://www.garmin.com/prop65).

Utilities

System

Messages



**NOTE:** Canadian installations: In accordance with Canadian Radio Specifications Standard 102 (RSS 102), RF field strength exposure to persons from an antenna connected to this device should be limited to 60V/m for controlled environment and 28 V/m for uncontrolled environment.

Symbols

Appendix

Index

NOTE: This device complies with Part 15 of the FCC limits for Class B digital devices. This equipment generates, uses, and can radiate radio frequency energy and, if not installed and used in accordance with the instructions, may cause harmful interference to radio communications. Furthermore, there is no guarantee that interference will not occur in a particular installation.

If this equipment does cause harmful interference, the user is encouraged to try to correct the interference by relocating the equipment or connecting the equipment to a different circuit than the affected equipment. Consult an authorized dealer or other qualified avionics technician for additional help if these remedies do not correct the problem.

Operation of this device is subject to the following conditions: (1) This device may not cause harmful interference, and (2) this device must accept any interference received, including interference that may cause undesired operation.

To obtain accessories for your unit, please contact your Garmin dealer.

Help us better support you by completing our on-line registration form today! Registration ensures that you will be notified of product updates and new products and provides lost or stolen unit tracking. Please, have the serial number of your unit handy, connect to our web site ([www.garmin.com](http://www.garmin.com)) and look for our Product Registration link on the Home page.

The display surface is coated with a special anti-reflective coating which is very sensitive to skin oils, waxes and abrasive cleaners. It is very important to clean the lens using an eyeglass lens cleaner which is specified as safe for anti-reflective coatings and a clean, lint-free cloth.

AC 90-100A Statement of Compliance:  
The Garmin navigational unit meets the performance and functional requirements of AC 90-100A.

## Product Registration and Support

Help us better support you by completing your online registration today! Have the serial number of your product handy and connect to the Garmin web site ([www.garmin.com](http://www.garmin.com)). Look for the Product Registration link on the Home page. Also, be sure to record your serial number in the space provided.

If you have any questions, the Garmin Product Support department may be reached Monday through Friday, 7:00 AM to 7:00 PM Central Time.

US: 913-397-8200

US Toll Free: 1-866-739-5687

Canada Toll Free: 1-866-429-9296

Foreword

Getting Started

Audio & Xpdr Ctrl

Com/Nav

FPL

Direct-To

Proc

Charts

Wpt Info

Map

Traffic

Terrain

Weather

Nearest

Music

Utilities

System

Messages

Symbols

Appendix

**Record of Revisions**

<b>Part Number</b>	<b>Revision</b>	<b>Date</b>	<b>Description</b>
190-01007-03	1	1/24/11	Initial Release
	A	2/4/11	Production Release
	B		

Getting Started

Audio &amp; Xpdr Ctrl

Com/Nav

FPL

Direct-To

Proc

Charts

Wpt Info

Map

Traffic

Terrain

Weather

Nearest

Music

Utilities

System

Messages

Symbols

Appendix



# Contents

Product Registration and Support .....	v	Getting Started
Welcome .....	xvii	Audio & Xpdr Ctrl
About This Guide.....	xvii	Com/Nav
Conventions.....	xviii	FPL
<b>1 Getting Started.....</b>	<b>1-1</b>	Direct-To
1.1 Model Descriptions .....	1-1	Proc
1.1.1 GTN 725.....	1-1	Charts
1.1.2 GTN 750.....	1-2	Wpt Info
1.2 About This Pilot's Guide .....	1-2	Map
1.2.1 Conventions.....	1-2	Traffic
1.2.2 Using the Touchscreen.....	1-2	Terrain
1.3 Product Description.....	1-3	Weather
1.3.1 Secure Data Card .....	1-3	Nearest
1.3.2 Pilot Controls .....	1-4	Music
1.3.2.1 Volume/Squelch Knob.....	1-4	Utilities
1.3.2.2 Large/Small Concentric Knobs.....	1-4	System
1.3.2.3 HOME Key.....	1-5	Messages
1.3.2.4 Direct-To Key.....	1-5	Symbols
1.3.2.5 Touchscreen Keys .....	1-5	Appendix
1.4 Unit Power Up .....	1-6	
1.4.1 Start-Up Screens.....	1-6	
1.4.2 Database Verification and Fuel Settings.....	1-7	
1.5 System Operation.....	1-11	
1.5.1 Using the Touchscreen Key Controls .....	1-11	
1.5.2 System Page.....	1-11	
1.5.2.1 System Settings Values .....	1-12	
1.5.2.2 Units Settings Values .....	1-13	
1.5.2.3 Alerts Settings Values .....	1-13	
1.5.3 Dual GTN 7XX Installations .....	1-14	
1.6 Direct-To Navigation .....	1-15	
1.6.1 Direct-To a Waypoint .....	1-15	
1.6.2 Direct-To a Flight Plan Waypoint .....	1-15	
1.6.3 Direct-To a Nearest Airport .....	1-15	
1.7 Selecting Com/Nav Frequencies.....	1-16	
1.8 Flight Planning .....	1-17	

	1.8.1	Creating a Flight Plan .....	1-17
Foreword	1.9	IFR Procedures .....	1-18
Getting Started	1.10	Dead Reckoning .....	1-19
Audio & Xpdr Ctrl	<b>2</b>	<b>Audio and Transponder Controls (Optional) .....</b>	<b>2-1</b>
Com/Nav	2.1	Transponder Operation .....	2-1
FPL	2.1.1	Select Transponder .....	2-2
Direct-To	2.1.2	IDENT .....	2-2
Proc	2.1.3	Standby .....	2-2
Charts	2.1.4	Ground .....	2-3
Wpt Info	2.1.5	On .....	2-3
Map	2.1.6	Altitude Reporting .....	2-3
Traffic	2.1.7	VFR .....	2-3
Terrain	2.1.8	Selecting a Squawk Code .....	2-4
Weather	2.2	Audio Panel Operation .....	2-6
Nearest	2.2.1	Mic Selection .....	2-8
Music	2.2.1.1	Mic Window Mic Selection .....	2-8
Utilities	2.2.1.2	Audio Panel Page Mic Selection .....	2-8
System	2.2.2	Monitor .....	2-9
Messages	2.2.3	Passenger Address .....	2-9
Symbols	2.2.4	Cabin Speaker Selection and Volume .....	2-10
Appendix	2.2.5	Marker Audio and Volume .....	2-10
	2.2.6	Marker Hi Sense .....	2-11
	2.2.7	Marker Beacon Annunciations .....	2-11
	2.2.8	Audio Split Mode .....	2-12
	2.2.9	Playback Controls .....	2-13
	2.3	Intercom Setup .....	2-14
	2.3.1	Set Pilot, Co-Pilot, & Passenger Volume and Squelch .....	2-17
	2.3.2	Music 1 and Music 2 Configuration .....	2-18
	2.3.3	Telephone Configuration .....	2-19
	<b>3</b>	<b>NAV/COM .....</b>	<b>3-1</b>
	3.1	Volume .....	3-2
	3.2	Squelch .....	3-2
	3.3	Com Window and Tuning .....	3-3
	3.3.1	Com Frequency Finding .....	3-5
	3.3.1.1	Find Recent Frequencies .....	3-6
	3.3.1.2	Find Nearest Frequencies .....	3-6
	3.3.1.3	Find Flight Plan Frequencies .....	3-9

3.3.1.4	Find User Frequencies.....	3-9
3.3.2	Adding a New User Frequency.....	3-9
3.3.3	Emergency Frequency.....	3-12
3.3.4	Stuck Microphone.....	3-12
3.3.5	Remote Frequency Selection Control.....	3-13
3.4	Com Frequency Monitoring.....	3-14
3.5	NAV (VOR/Localizer/Glideslope) Receiver Operations.....	3-15
3.5.1	Ident Audio and Volume.....	3-15
3.5.2	Nav Tuning Window.....	3-16
3.5.3	Nav Frequency Finding.....	3-17
<b>4</b>	<b>Flight Plans.....</b>	<b>4-1</b>
4.1	Creating a New Flight Plan.....	4-2
4.1.1	Creating a New Flight Plan in the Catalog.....	4-2
4.1.2	Creating a New Flight Plan from the Active Flight Plan.....	4-3
4.2	Active Flight Plan Page.....	4-4
4.2.1	Waypoint Options.....	4-5
4.2.1.1	Activate Leg.....	4-6
4.2.1.2	Insert Before.....	4-7
4.2.1.3	Insert After.....	4-9
4.2.1.4	Remove.....	4-9
4.2.1.5	Load Procedures.....	4-10
4.2.1.6	Waypoint Info.....	4-11
4.2.2	Airways.....	4-12
4.3	Flight Plan Menu.....	4-16
4.3.1	Store Flight Plan.....	4-17
4.3.2	Invert Flight Plan.....	4-17
4.3.3	Parallel Track.....	4-18
4.3.4	Edit Data Fields.....	4-21
4.3.5	Flight Plan Catalog Route Options.....	4-23
4.3.5.1	Catalog Route Option - Activate.....	4-24
4.3.5.2	Catalog Route Option - Invert & Activate.....	4-24
4.3.5.3	Catalog Route Option - Preview.....	4-25
4.3.5.4	Catalog Route Option - Edit.....	4-25
4.3.5.5	Catalog Route Option - Copy.....	4-26
4.3.5.6	Catalog Route Option - Delete.....	4-27
4.3.6	Delete Flight Plan.....	4-28
4.3.6.1	Delete Flight Plan from Catalog.....	4-28

Foreword
Getting Started
Audio & Xpdr Ctrl
Com/Nav
FPL
Direct-To
Proc
Charts
Wpt Info
Map
Traffic
Terrain
Weather
Nearest
Music
Utilities
System
Messages
Symbols
Appendix

Foreword	4.3.6.2	Delete Active Flight Plan .....	4-29
	4.3.8	Preview Flight Plan .....	4-30
Getting Started	4.3.8.1	Previewing the Active Flight Plan .....	4-30
	4.3.8.2	Previewing a Flight Plan in the Catalog .....	4-30
Audio & Xpdr Ctrl	<b>5</b>	<b>Direct-To.....</b>	<b>5-1</b>
	5.1	Direct-To Navigation .....	5-1
Com/Nav	5.2	Direct-To a Flight Plan Waypoint.....	5-3
	5.3	Direct-To a Nearest Airport.....	5-4
FPL	5.4	Removing a Direct-To Course .....	5-6
	5.5	Direct-To Map Waypoint.....	5-7
Direct-To	5.6	Off-Route Direct-To Course .....	5-8
	<b>6</b>	<b>Procedures .....</b>	<b>6-1</b>
Proc	6.1	Basic Approach Operations .....	6-2
	6.2	Selecting a Departure.....	6-4
Charts	6.3	Selecting an Arrival .....	6-7
	6.4	Selecting an Approach .....	6-10
Wpt Info	6.5	Approaches with Procedure Turns.....	6-13
	6.6	Flying the Missed Approach .....	6-14
Map	6.7	Flying an Approach with a Hold.....	6-14
	6.8	Flying a DME Arc Approach .....	6-15
Traffic	6.9	Vectors to Final.....	6-15
	6.10	ILS Approaches (GTN 750 Only) .....	6-16
Terrain	6.11	RNAV Approach Procedures .....	6-17
	6.12	Points to Remember for All Procedures .....	6-18
Weather	6.13	Points to Remember for Localizer or VOR-based Approaches .....	6-18
	6.14	Enabling Autopilot Outputs for the King KAP140/KFC225.....	6-20
Nearest	<b>7</b>	<b>Charts .....</b>	<b>7-1</b>
Music	7.1	Chart Page .....	7-3
	7.1.1	Airport Selection.....	7-3
Utilities	7.1.2	Info.....	7-4
	7.1.3	Information .....	7-4
System	7.1.4	Approaches.....	7-5
	7.1.5	Departures .....	7-6
Messages	7.1.6	Arrivals .....	7-7
	7.1.7	Airport Info .....	7-8
Symbols	7.1.8	Full/Split Screen.....	7-9
Appendix	7.2	Chart Menu Options .....	7-10

7.2.1	Chart Layers - All .....	7-11
7.2.2	Chart Layers - Header .....	7-11
7.2.3	Chart Layers - Plan .....	7-11
7.2.4	Chart Layers - Profile .....	7-12
7.2.5	Chart Layers - Minimums .....	7-12
7.2.6	Invert Colors .....	7-13
7.3	ChartView Cycle Number and Revision .....	7-13
7.4	FliteCharts® .....	7-14
7.4.1	FliteCharts Cycle Number and Revision .....	7-15
7.5	SafeTaxi® .....	7-16
7.5.1	Using SafeTaxi® .....	7-16
7.5.2	Hot Spot Information .....	7-17
7.5.3	SafeTaxi® Cycle Number and Revision .....	7-17
<b>8</b>	<b>Waypoint Info .....</b>	<b>8-1</b>
8.1	Waypoint Selection .....	8-3
8.2	Airport .....	8-4
8.2.1	Info .....	8-4
8.2.2	Preview .....	8-5
8.2.3	Procedures .....	8-6
8.2.4	Runways .....	8-7
8.2.5	Frequencies .....	8-8
8.2.6	Weather (WX) Data .....	8-9
8.2.7	NOTAM Pages .....	8-10
8.3	Intersection (INT) .....	8-11
8.4	VOR .....	8-12
8.5	NDB .....	8-13
8.6	User Waypoints (User) .....	8-14
8.6.1	Select User Waypoint By Name .....	8-15
8.6.2	Select User Waypoint From A List .....	8-15
8.6.3	Edit User Waypoint .....	8-15
8.6.4	Delete User Waypoint .....	8-15
8.7	Create Waypoint .....	8-16
8.7.1	Waypoint Location Based on Lat/Lon Coordinates .....	8-18
8.7.2	Waypoint Location Based on Two Radials .....	8-19
8.7.3	Waypoint Location Based on Radial and Distance .....	8-20
<b>9</b>	<b>Map .....</b>	<b>9-1</b>
9.1	Map Menu .....	9-3

Foreword

Getting Started

Audio &amp; Xpdr Ctrl

Com/Nav

FPL

Direct-To

Proc

Charts

Wpt Info

Map

Traffic

Terrain

Weather

Nearest

Music

Utilities

System

Messages

Symbols

Appendix

Foreword	9.1.1	Map Overlays .....	9-4
	9.1.1.1	Topo .....	9-4
Getting Started	9.1.1.2	Airways .....	9-5
	9.1.1.3	Terrain .....	9-6
Audio & Xpdr Ctrl	9.1.1.4	NEXRAD (Optional) .....	9-7
	9.1.1.5	Charts (Optional).....	9-7
Com/Nav	9.1.1.6	StormScope® (Optional).....	9-8
	9.1.1.7	Traffic (Optional).....	9-9
FPL	9.1.2	Map Setup .....	9-10
	9.1.2.1	Map.....	9-12
Direct-To	9.1.2.2	Aviation .....	9-18
	9.1.2.3	Land .....	9-19
Proc	9.1.2.4	Airway Range.....	9-19
	9.1.2.5	Traffic (Optional).....	9-20
Charts	9.1.2.6	Weather (Optional).....	9-21
	9.1.3	Map Data Fields .....	9-21
Wpt Info	9.1.4	Map Detail .....	9-23
Map	9.2	Map Panning .....	9-25
	9.3	Map Controls.....	9-28
Traffic	9.3.1	Pan Map Mode.....	9-28
	9.3.2	Create Waypoint.....	9-28
Terrain	9.3.3	Graphically Edit Flight Plan Mode .....	9-29
	9.3.3.1	Adding a Waypoint Within an Existing Flight Plan.....	9-29
Weather	9.3.3.2	Adding a Waypoint to the End of an Existing Flight Plan.....	9-31
	9.3.3.3	Removing a Waypoint from an Existing Flight Plan .....	9-31
Nearest	9.3.3.4	Creating a Flight Plan Without an Existing Flight Plan.....	9-31
	9.4	CDI (GTN 750 only) .....	9-33
Music	9.5	OBS .....	9-34
	9.6	Map Symbols.....	9-35
Utilities	<b>10</b>	<b>Traffic .....</b>	<b>10-1</b>
	10.1	Traffic Information Service (TIS) (Optional) .....	10-1
System	10.1.1	TIS Symbology .....	10-2
	10.1.2	Traffic Page .....	10-3
Messages	10.1.3	Displaying Traffic on the Traffic Page.....	10-4
	10.1.4	Altitude Display .....	10-4
Symbols	10.1.5	TIS Limitations.....	10-5
Appendix	10.1.6	TIS Alerts.....	10-7

10.1.7	TIS System Status .....	10-8
10.2	TAS Traffic (Optional).....	10-10
10.2.1	TAS Symbology.....	10-11
10.2.2	Displaying and Operating Traffic (TAS Systems).....	10-12
10.2.2.1	Switching from Standby Mode to Operating Mode .....	10-12
10.2.2.2	Range Ring .....	10-13
10.2.3	Altitude Display.....	10-13
10.2.4	Traffic System Status.....	10-14
10.2.5	Traffic Pop-Up.....	10-15
10.3	Traffic Test .....	10-16
<b>11</b>	<b>Terrain .....</b>	<b>11-1</b>
11.1	Terrain Configurations.....	11-1
11.2	Terrain Proximity .....	11-1
11.2.1	Displaying Terrain Proximity .....	11-3
11.2.1.1	Terrain Page 120° Arc or 360° Rings.....	11-4
11.2.2	Terrain Limitations .....	11-5
11.3	Terrain Awareness and Warning System (TAWS-B) Optional.....	11-6
11.3.1	TAWS-B Requirements.....	11-6
11.3.2	TAWS-B Limitations .....	11-6
11.3.3	Computing GPS Altitude for TAWS .....	11-7
11.3.4	Baro-Corrected Altitude Versus GSL Altitude.....	11-7
11.3.5	Using TAWS .....	11-8
11.3.6	Displaying TAWS Data .....	11-8
11.3.7	TAWS Page .....	11-9
11.3.7.1	Terrain Page Layers.....	11-10
11.3.7.2	Terrain Page View .....	11-11
11.3.7.3	Terrain Page TAWS Selections .....	11-11
11.3.8	TAWS Alerts .....	11-12
11.3.8.1	TAWS-B Alerting Colors and Symbology .....	11-13
11.3.8.2	Excessive Descent Rate Alert.....	11-15
11.3.8.3	Forward Looking Terrain Avoidance .....	11-15
11.3.8.4	Premature Descent Alerting .....	11-16
11.3.8.5	Inhibiting/Enabling TAWS Alerting.....	11-17
11.3.8.7	Negative Climb Rate After Take-Off Alert (NCR) .....	11-17
11.3.8.8	TAWS Not Available Alert.....	11-19
11.3.8.9	TAWS Failure Alert.....	11-19
11.3.9	TAWS System Status.....	11-19

Foreword
Getting Started
Audio & Xpdr Ctrl
Com/Nav
FPL
Direct-To
Proc
Charts
Wpt Info
Map
Traffic
Terrain
Weather
Nearest
Music
Utilities
System
Messages
Symbols
Appendix

<b>Foreword</b>	<b>12 Weather</b> .....	<b>12-1</b>
	12.1 XM Weather Products (Optional) .....	12-3
Getting Started	12.1.1 Displaying Data Link Weather .....	12-3
	12.1.2 Weather Legend .....	12-5
Audio & Xpdr Ctrl	12.1.3 Weather Map Orientation .....	12-6
	12.1.4 XM Weather Symbols and Product Age .....	12-7
Com/Nav	12.1.5 NEXRAD .....	12-9
	12.1.5.1 Reflectivity .....	12-10
FPL	12.1.5.2 NEXRAD Limitations .....	12-11
	12.1.6 Echo Tops .....	12-13
Direct-To	12.1.7 Cloud Tops .....	12-14
	12.1.8 Cell Movement .....	12-15
Proc	12.1.9 SIGMETs and AIRMETS .....	12-16
	12.1.10 County Warnings .....	12-17
Charts	12.1.11 Freezing Level .....	12-18
	12.1.12 METARs .....	12-19
Wpt Info	12.1.13 Cyclone .....	12-20
	12.1.14 Lightning .....	12-21
Map	12.1.15 Weather Forecast .....	12-22
	12.1.16 Winds Aloft .....	12-24
Traffic	12.1.17 Icing .....	12-25
	12.1.18 Turbulence .....	12-26
Terrain	12.1.19 AIREP/PIREP .....	12-27
Weather	12.2 StormScope® Weather .....	12-28
	12.2.1 StormScope® (Optional) .....	12-28
Nearest	12.2.2 Clearing the StormScope® Page .....	12-29
	12.2.3 Changing the StormScope® Display View .....	12-30
Music	12.2.4 Changing the Storm Data Display Range .....	12-30
	12.2.5 Displaying StormScope® Data on the Map Page .....	12-31
Utilities	<b>13 Nearest</b> .....	<b>13-1</b>
	13.1 Select a Nearest Page .....	13-2
System	13.2 Nearest Airport .....	13-2
Messages	13.3 Nearest Intersection (INT) .....	13-4
	13.4 Nearest VOR .....	13-6
Symbols	13.5 Nearest NDB .....	13-8
	13.6 Nearest User Waypoint .....	13-9
Appendix	13.7 Nearest Airspace .....	13-10



13.8	Nearest ARTCC .....	13-13
13.9	Nearest Flight Service Station (FSS) .....	13-15
13.10	Nearest Weather Frequency (WX Freq).....	13-17
<b>14</b>	<b>Music .....</b>	<b>14-1</b>
14.1	Activating XM® Satellite Radio Services .....	14-2
14.2	Music Operation .....	14-3
14.2.1	Browsing Channels and Categories.....	14-4
14.2.2	Selecting an XM® Radio Channel by Number .....	14-5
14.2.3	XM® Radio Volume.....	14-6
14.2.4	XM® Radio Channel Presets.....	14-7
14.2.4.1	Saving a Preset.....	14-7
14.2.4.2	Recalling a Preset.....	14-7
14.3	GDL 69/69A Data Link Receiver Troubleshooting.....	14-8
<b>15</b>	<b>Utilities .....</b>	<b>15-1</b>
15.1	Vertical Calculator (VCALC) .....	15-3
15.1.1	Target Altitude.....	15-5
15.1.2	Altitude Type .....	15-5
15.1.3	Vertical Speed (VS) Profile.....	15-6
15.1.4	Target Offset .....	15-7
15.1.5	Before/After Target Waypoint .....	15-7
15.1.6	Target Waypoint .....	15-8
15.1.7	Display VCALC Messages.....	15-9
15.1.8	Restore VCALC Defaults.....	15-9
15.2	Flight Timers .....	15-10
15.3	RAIM Prediction.....	15-11
15.4	Trip Planning .....	15-12
15.4.1	Point-To-Point Mode.....	15-14
15.4.2	Flight Plan Mode .....	15-18
15.5	Fuel Planning.....	15-21
15.5.1	Point-To-Point Mode.....	15-22
15.5.2	Flight Plan Mode .....	15-25
15.6	DALT/TAS/Winds .....	15-27
15.7	Clean Screen Mode.....	15-31
<b>16</b>	<b>System .....</b>	<b>16-1</b>
16.1.1	Serial Number and System ID.....	16-4
16.1.2	Version Information.....	16-4
16.1.3	Database Information.....	16-4

Foreword
Getting Started
Audio & Xpdr Ctrl
Com/Nav
FPL
Direct-To
Proc
Charts
Wpt Info
Map
Traffic
Terrain
Weather
Nearest
Music
Utilities
System
Messages
Symbols
Appendix

Foreword	16.2	GPS Status.....	16-7
	16.2.1	GPS Status Page.....	16-7
Getting Started	16.2.2	Satellite-Based Augmentation System (SBAS) .....	16-10
	16.2.3	Circle of Uncertainty.....	16-11
Audio & Xpdr Ctrl	16.3	External LRUs .....	16-12
	16.3.1	GDL 69 (and GDL 69A) Status .....	16-12
Com/Nav	16.4	Setup.....	16-14
	16.4.1	System Setup.....	16-15
FPL	16.4.1.1	Date/Time .....	16-15
	16.4.1.2	Com Channel Spacing .....	16-16
Direct-To	16.4.1.3	Nearest Airport Criteria.....	16-16
	16.4.1.4	Crossfill.....	16-18
Proc	16.4.1.5	CDI Scale Selection .....	16-19
	16.5	Alerts Settings .....	16-20
Charts	16.6	Units Settings .....	16-22
	16.6.1	Setup Units .....	16-22
Wpt Info	16.6.2	Setting a User-Configured (Manual) Nav Angle .....	16-24
Map	16.7	Audio .....	16-26
	16.8	Ownship Settings.....	16-27
Traffic	16.9	Backlight Settings .....	16-28
	<b>17</b>	<b>Messages .....</b>	<b>17-1</b>
Terrain	<b>18</b>	<b>Symbols.....</b>	<b>18-1</b>
	18.1	Map Page Symbols.....	18-1
Weather	18.2	SafeTaxi™ Symbols .....	18-2
Nearest	18.3	Traffic Symbols.....	18-2
	18.4	Terrain Obstacle Symbols .....	18-3
Music	18.5	Basemap Symbols .....	18-4
	18.6	Map Tool Bar Symbols.....	18-4
Utilities	18.7	Miscellaneous Symbols .....	18-5
	<b>19</b>	<b>Appendix.....</b>	<b>19-1</b>
System	19.1	Glossary .....	19-1
	19.2	SD Card Use and Databases.....	19-9
Messages	19.2.1	Jeppesen Databases .....	19-9
	19.2.2	Garmin Databases .....	19-10
Symbols	19.3	Demo Mode .....	19-13
Appendix	19.4	Glove Qualification Procedure .....	19-16
		<b>Index.....</b>	<b>Index-1</b>

## Welcome ...

Welcome to the GTN era of navigation. The Garmin GTN supports airway navigation and flexible flight planning, including arrival and departure procedures and precision approaches. All of these advanced features are easily accessed with an easy-to-use touchscreen display, another first for general aviation. You can be confident in knowing that this product has been designed to meet or exceed industry performance standards and is supported through a global network of Garmin Aviation Distributors.

## About This Guide

Take a little time to review the various sections of this guide to familiarize yourself with it. First, read Section 1 as an introduction to quickly get you started with the GTN. The other sections are not meant to necessarily be read in order, but provide detailed information on the subject they contain as you need them. Do take the time to review the information before using the product to assist you in getting the most out of your avionics.

Generally, a feature will be described in a section that provides a brief description, a graphic functional diagram, and step-by-step procedures. If read cover-to-cover sequentially, the information may seem repetitive. The guide is designed as a reference where you will generally skip around the document learning about a particular feature or function after becoming familiar with the unit.

## Conventions

The GTN display dynamically tailors the number and position of the controls for each function and are engaged by merely touching them.

**Touch** Touch the key with your finger.

**Drag** Touch the list or location on the map with your finger. Continue lightly holding your finger to the display surface and drag your finger in the intended direction to scroll through the list or move the location on the map.

In this pilot's guide, keys are noted by bold text. An image of the key used will be shown to the left of a procedure. Keys are outlined areas on the display. Figures in the guide will identify the available controls. A key may have a name of a control, such as **Enter**, **Terrain**, or **Back**. A key may also be an information field, such as a numeric value that can be changed.

*Graphic Of Key*



While viewing the Map Menu, touch the **Terrain** Map Overlay key to toggle the view of Terrain data.

*Text Description Of Key*

*Graphic Of Key With Numeric Value*



*Text Description Of Key*

When the Fuel on Board value is selected, touch the **Fuel on Board** key to display the Fuel on Board values.

*List "Keys." Touch To Select.*



*Scroll Bar Indicates More Selections Available. Touch Finger To An Item In The List And Drag Your Finger To View More Selections.*

*Selected Field Type*

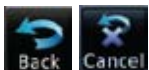

Touching the **Back** key returns to the previous display. The **Cancel** key cancels any information selected or entered and returns to the previous display.

Foreword

Getting Started

Audio & Xpdr Ctrl

Com/Nav

FPL

Direct-To

Proc

Charts

Wpt Info

Map

Traffic

Terrain

Weather

Nearest

Music

Utilities

System

Messages

Symbols

Appendix

# 1 GETTING STARTED

## 1.1 Model Descriptions

This guide covers the operation of the GTN 725 and 750. In general, all models will be referred to as the GTN 7XX, except where there are physical or operational differences. The GTN units are 6.25 inches wide and 6 inches high. The display is a 800 by 600 pixel, 6.9 inch diagonal color LCD with touchscreen controls. The units include one removable SD data card for the databases and software upgrades.

The GTN 7XX simplifies your workload with an easy-to-use touch panel that provides a visual display of both controls and functions. The required controls are displayed for the selected function. Keys on the display allow you to access and control their functions by a simple touch on the interactive display.

The GTN 7XX can integrate a variety of avionics that will not only simplify operation, but also save panel space. The GTN 725 and 750 have their own GPS/ SBAS navigator and flight planning functions. The GTN 750 adds VHF Com and VHF Nav radios. Selected optional external equipment allows you to display and control active traffic systems, XM Entertainment Radio, XM Weather, audio panel, and a Mode S transponder directly from the GTN 7XX display, and more.

### 1.1.1 GTN 725

The GTN 725 has a GPS/SBAS engine and is TSO C146c certified for primary domestic, oceanic, and remote navigation including en route, terminal, and non-precision approaches, and approaches with vertical guidance, such as LPV and LNAV/VNAV. The GTN 725 can simultaneously give aviators vital approach information and weather and traffic data in relation to their position on a large, color moving map display. Thanks to a high-contrast color display, the information can be easily read from wide viewing angles even in direct sunlight. Its color moving map features a built-in database that shows cities, highways, railroads, rivers, lakes, coastlines, and a complete Jeppesen database. The Jeppesen database (that can be updated with a front-loading data card) contains all airports, VORs, NDBs, Intersections, FSSs, Approaches, DPs/STARs, and SUA information.

Pilots will enjoy the GTN 725 as a flexible and powerful navigator, especially

when it is coupled with traffic, lightning detection, and weather interfaces. With the PC-based FDE prediction program, the GTN 725 may be used for oceanic or remote operations. For the latest in graphic and text weather information, the GTN 725 can interface to XM Satellite Radio's XM Weather Service via the Garmin GDL 69/69A datalink receiver.

## 1.1.2 GTN 750

The GTN 750 includes all of the features of the GTN 725, and also includes a TSO'd airborne VHF communications transceiver and TSO'd airborne VOR/Localizer and Glideslope receivers.

# 1.2 About This Pilot's Guide

## 1.2.1 Conventions

Bold text indicates a control. The **small right** knob is the smaller, inner knob of the two concentric rotary knobs on the lower, right corner of the bezel. The **large right** knob is the larger, outer knob.

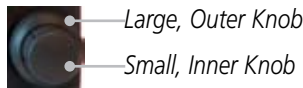

Figure 1-1 Large/Small Concentric Knobs

A graphic of a control on the side of the page refers to the control you should use for the associated step as shown below.

## 1.2.2 Using the Touchscreen

Most of the controls are operated by touching the display. Highlighted icons and keys may be simply touched to make a selection. A list of menu items may be scrolled by touching the screen and retaining pressure while sliding your finger up or down. Map displays may be panned by touching the screen and retaining pressure while sliding your finger in the desired direction.



You can return to the previous page or exit the current function by touching the **Back** key.



Quickly return to the Home page by pressing the **HOME** key. Press and hold the **HOME** key to reach the Map page.

## 1.3 Product Description

This section provides an overview of the GTN 7XX product and a quick look at some important features. The GTN 7XX presents a full-color moving map with navigation information to the pilot through a large-format display. Controls are a combination of rotary knobs and push-keys on the bezel with the color display providing information as well as a touchscreen controls. The GTN 7XX has a 800 x 600 pixel, 6.9 inch LCD display.

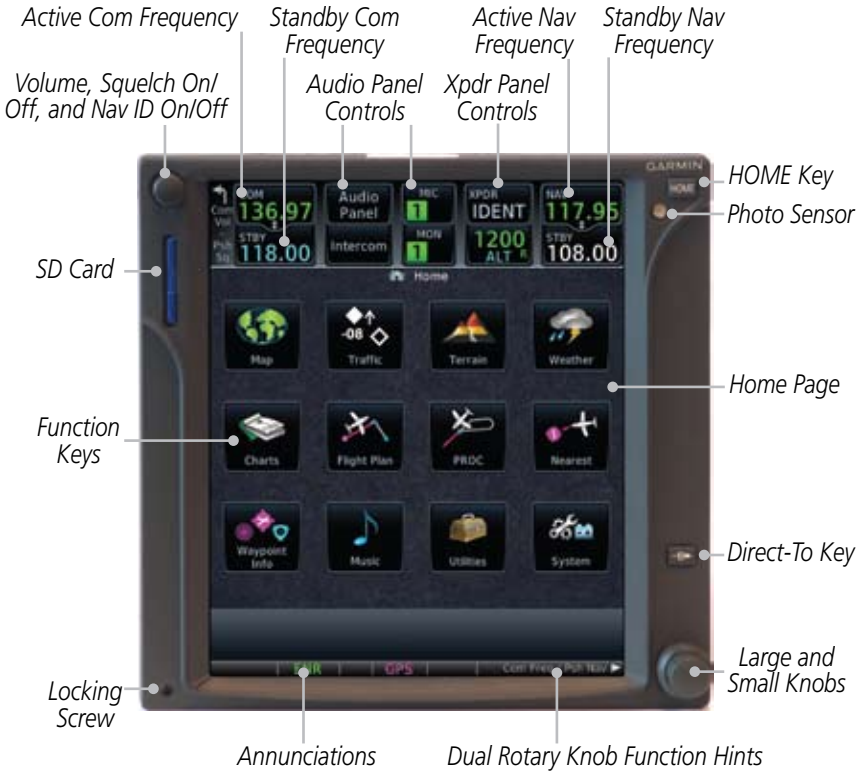

Figure 1-2 GTN 750 Front Panel

### 1.3.1 Secure Data Card

The GTN 7XX uses a Secure Digital (SD) card to load and store various types of data. For basic flight operations, the SD card is required for Terrain, FliteChart, and ChartView database storage. An SD card is used for Obstacle, Basemap, SafeTaxi, Aviation, and ChartView database updates.



**NOTE:** Ensure the GTN 7XX is powered off before inserting or removing an SD card.



**NOTE:** Refer to SD Card Use and Databases in the Appendix for instructions on updating databases.

## Inserting an SD Card

1. Insert the SD card in the SD card slot (the label side of the card should face the right edge of the display bezel).
2. To eject the card, gently press on the SD card to release the spring latch.

## 1.3.2 Pilot Controls

The GTN 7XX controls have been designed to simplify operation of the system and minimize workload and the time required to access sophisticated functionality. Controls are located on the bezel and on the touchscreen display. Controls are comprised of dual concentric knobs, volume/squelch knob, bezel keys, and active touch areas on the display.

### 1.3.2.1 Volume/Squelch Knob

The **Volume** knob located in the top left corner of the bezel controls audio volume for the selected Com radio or Nav receiver and external audio input devices that are controlled via the GTN interface to the optional remote-mounted audio panel, if installed. When the Com radio is active, press the **Volume** knob momentarily to disable automatic squelch control for the Com radio. When the Nav radio is active, press the **Volume** knob momentarily to enable/disable the ident tone for the Nav radio.



Figure 1-3 Volume/Squelch Knob

### 1.3.2.2 Large/Small Concentric Knobs

The **large right** and **small right** knobs are used for data entry, such as in the Waypoint or Direct-To functions, and to set the frequencies for the communications transceiver or the VOR/Localizer receiver in units so equipped.



Figure 1-4 Large/Small Concentric Knobs



## 1.3.2.3 HOME Key

Pressing the **HOME** key displays the Home page, the main screen for accessing the GTN features. Pressing and holding the **HOME** key will open the Map page from any other page.



Figure 1-5 HOME Key

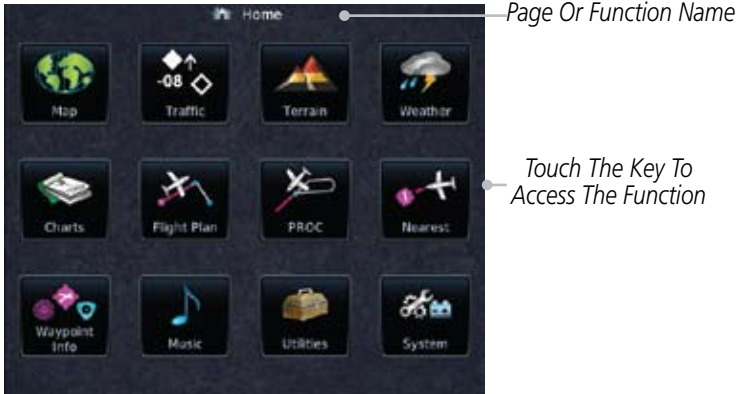

Figure 1-6 Home Page

## 1.3.2.4 Direct-To Key

The **Direct-To** key provides access to the direct-to function, which allows you to enter a waypoint and establishes a direct course to the selected destination.



Figure 1-7 Direct-To Key

## 1.3.2.5 Touchscreen Keys

Touchscreen keys are placed at the lower portion of the display. The keys vary depending on the page selected. Touch the key to perform the function or access the described information.



Figure 1-8 Touchscreen Key Control Example

# 1.4 Unit Power Up

The GTN 7XX System is integrated with the aircraft electrical system and receives power directly from electrical busses. The GTN 7XX and supporting sub-systems include both power-on and continuous built-in test features that exercise the processor, memory, external inputs, and outputs to ensure safe operation.

## 1.4.1 Start-Up Screens

During system initialization, test annunciations are displayed. All system annunciations should disappear typically within the first 30 seconds after power-up. Upon power-up, key annunciator lights also become momentarily illuminated on the GTN 7XX display bezel.

The splash screen displays the following information:

- Copyright
- Database List and System version
- Instrument Panel Self-Test

Current database information includes valid operating dates, cycle number, and database type. When this information has been reviewed for currency (to ensure that no databases have expired), the pilot is prompted to continue. Databases that are not current will be shown in amber.



1 - Copyright

2 - SW & Database Versions & Dates

3 - Panel Self-Test

Figure 1-9 System Startup Pages

## 1.4.2 Database Verification and Fuel Settings

Continue

1. When the System and Database Version page appears, check to ensure databases are current. Then, touch **Continue**.



Figure 1-10 System Startup Pages

2. When the Instrument Panel Self-Test and Fuel Setting page appears, check to ensure that the CDI/HSI outputs and other displayed data are correct on the external interfaced equipment.

3. Touch each of the Fuel value keys and set the appropriate values as desired. Fuel capacity is shown in either gallons or pounds as set in the Units feature of System mode.

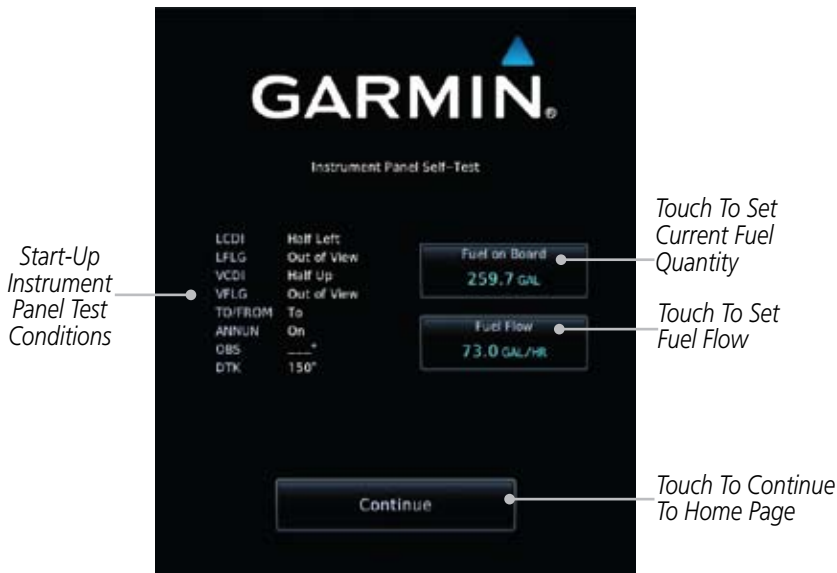

**Figure 1-11 Instrument Panel Self-Test & Fuel Settings Page**

4. When the Fuel on Board value is selected, touch the **Fuel on Board** key to display the Fuel on Board values. Touch the **Full** or **Tab**s keys to display those values after they have been set.



Figure 1-12 Fuel On Board Page

5. Touch the **Set Full/Tabs** key to set the fuel values for Fuel Full Capacity and Fuel Tab Capacity. After setting the fuel values, touch the **Back** and then the **Enter** keys to return to the Instrument Panel Self Test page.

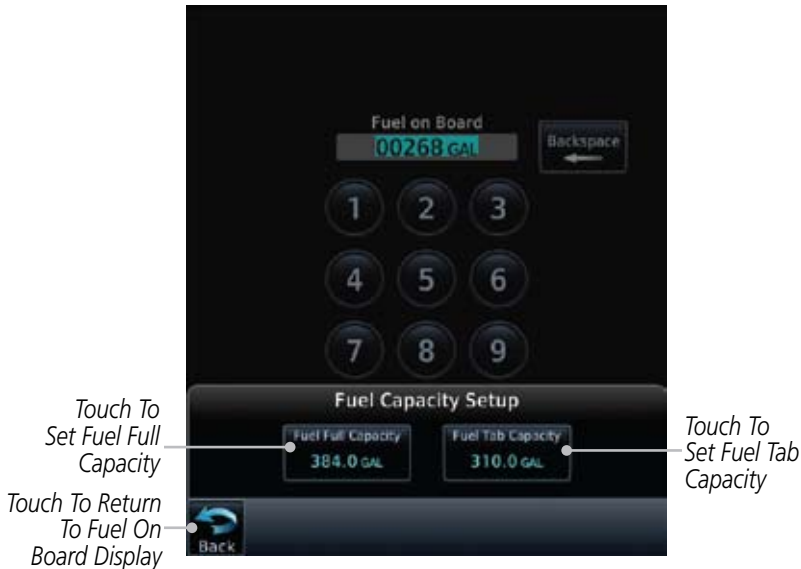
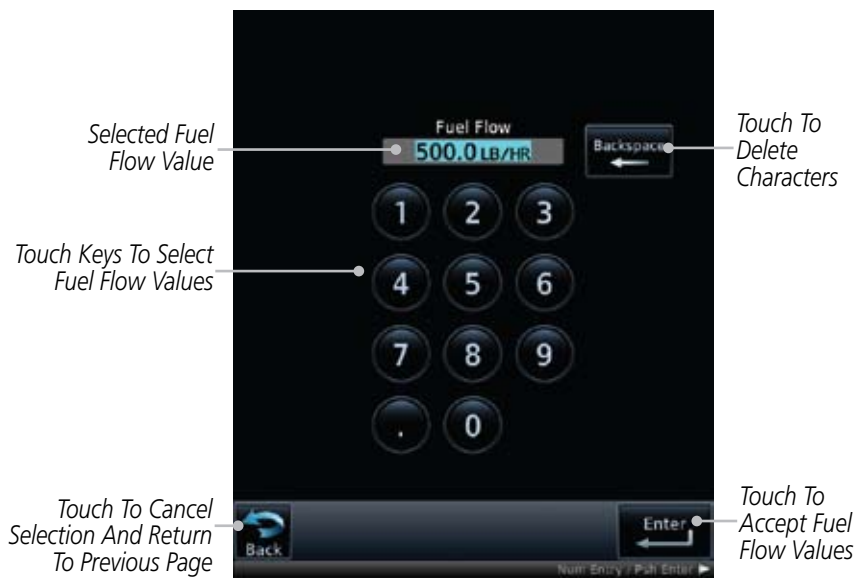

Figure 1-13 Fuel Capacity Setup Page

- On the Instrument Panel Self Test page, touch the **Fuel Flow** key and then use the numeric keypad to set those values. Touch the **Enter** key after selecting the Fuel Flow values.



**Figure 1-14 Fuel Flow Setup Page**

- Touch the **Back** key to return to the Fuel on Board page. Touch the **Enter** key to accept the fuel values and return to the Instrument Panel Self-Test page. Then, touch the **Continue** key to advance to the Home page.



**Figure 1-15 Home Page**

## 1.5 System Operation

### 1.5.1 Using the Touchscreen Key Controls

Except for the knobs, the **HOME**, and **Direct-To** keys on the bezel, the controls for the GTN 7XX are located on the display and activated by your touch.



Figure 1-16 On-Screen Keys and Active Display Areas

### 1.5.2 System Page

GTN 7XX system settings are managed in System Mode. The following features are available:

- System Status
- GPS Status
- External LRUs
- Setup
- Alerts Settings
- Units Settings
- Audio
- Ownship Symbol
- Backlight

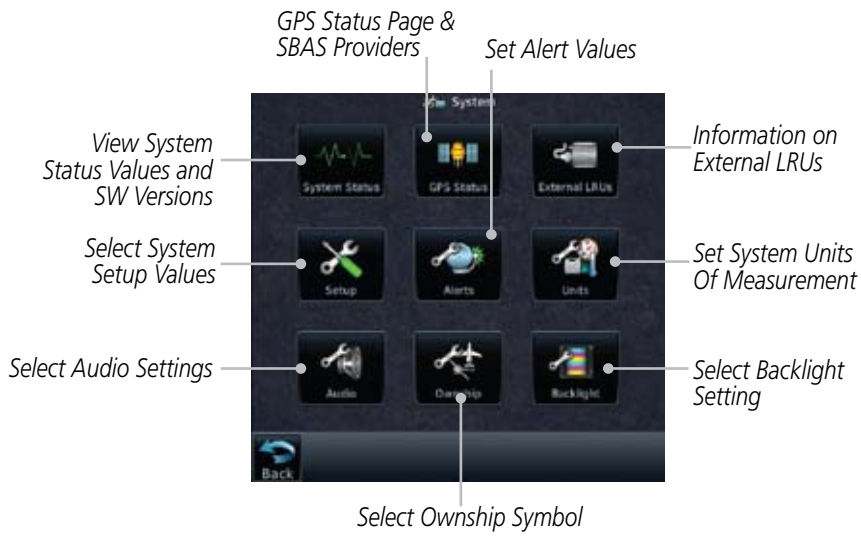

Figure 1-17 System Page

### 1.5.2.1 System Settings Values

- From the Home page, touch **System** and then **Setup**.
- Select the desired Time Format and Local Offset by touching the Time Format (**12 Hour**, **24 Hour**, and/or **UTC**) keys and selecting the appropriate Local Time Offset after touching the **Local Offset** key.
- Touch the **Com Channel Spacing** key to toggle between 8.33 and 25.0 kHz channel spacing.
- For Nearest Airport filtering, touch the **Runway Surface** key and select the desired type of surface that will appear in the Nearest Airport list.
- Touch the **Minimum Runway Length** key to select the minimum runway length allowed for the Nearest Airport. Selecting 0 feet will show all airports regardless of runway length.
- Touch the **Crossfill** key to enable or disable crossfill with a second GTN unit.





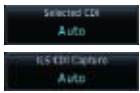

7. Select the CDI and ILS CDI Capture method with the **Selected CDI** and **ILS CDI Capture** keys.

## 1.5.2.2 Units Settings Values

1. From the Home page, touch **System** and then **Units**.



2. Touch the desired item key and select the desired value.
3. Continue to select the desired Units values and then touch the **Back** or **HOME** key to exit.

## 1.5.2.3 Alerts Settings Values

1. From the Home page, touch **System** and then **Alerts**.



2. Touch the Alert type key to toggle its active status. A lighted green bar under the label indicates that it is active.
3. Set arrival alerting. Touch the **Arrival** key. Touch the **Proximity** key and select the desired value with the keypad.
4. Touch the **Airspace Altitude Buffer** key and select the desired value for airspace alerting.
5. Continue to select the desired Alerts values and then touch the **Back** or **HOME** key to exit.



## 1.5.3 Dual GTN 7XX Installations

Dual GTN 7XX units when connected in the aircraft may be set up to communicate and share information by “Crossfilling” or synchronizing information between the two units.

The following Crossfill information is always synchronized between both GTN 7XX units:

- User Waypoints
- Flight Plan Catalog
- Alerts (traffic popup acknowledgement, missed approach waypoint popup acknowledgement, altitude leg popup acknowledgement)
- External sensors (transponder status and commands, synchro heading)
- System setup:
  - Favorite NAV frequencies
  - Date/Time convention
  - Nearest airport criteria
  - Units (Nav angle, Distance/Speed, etc.)
  - Favorite COM frequencies
  - Ownship icon
  - CDI Scale setting
  - ILS CDI Capture setting

This data is crossfilled only if crossfill is turned on by the pilot:

- Active navigation (flight plan)



---

**NOTE:** In dual GTN installations with crossfill on, the OBS course will only be updated real time on the GTN that is receiving the new OBS course. The course will be transferred to the other GTN when OBS is exited.

---

## 1.6 Direct-To Navigation

Press the **Direct-To** key to quickly navigate from your present position directly to a selected waypoint, flight plan waypoint, or nearest airport.

### 1.6.1 Direct-To a Waypoint



1. Press **Direct-To**.
2. Touch the Waypoint Identifier field and select the characters for the desired waypoint with the **large** and **small right** knobs or the touch keypad.
3. Touch **Activate** or press the **small right** knob. Text near the **small right** knob indicates its current function.



OR



### 1.6.2 Direct-To a Flight Plan Waypoint



1. Press **Direct-To**.
2. Touch the **FPL** tab and then the desired Flight Plan waypoint.
3. Touch **Activate** or press the **small right** knob.



OR



### 1.6.3 Direct-To a Nearest Airport



1. Press **Direct-To**.
2. Touch the **NRST APT** tab and then the desired airport from the Nearest Airport list. Touch the **Up** or **Down** keys as needed to show more of the list.
3. Touch **Activate** or press the **small right** knob.

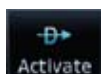

OR



## 1.7 Selecting Com/Nav Frequencies

Foreword

Getting Started

Audio & Xpdr Ctrl

Com/Nav

FPL

Direct-To

Proc

Charts

Wpt Info

Map

Traffic

Terrain

Weather

Nearest

Music

Utilities

System

Messages

Symbols

Appendix

Index

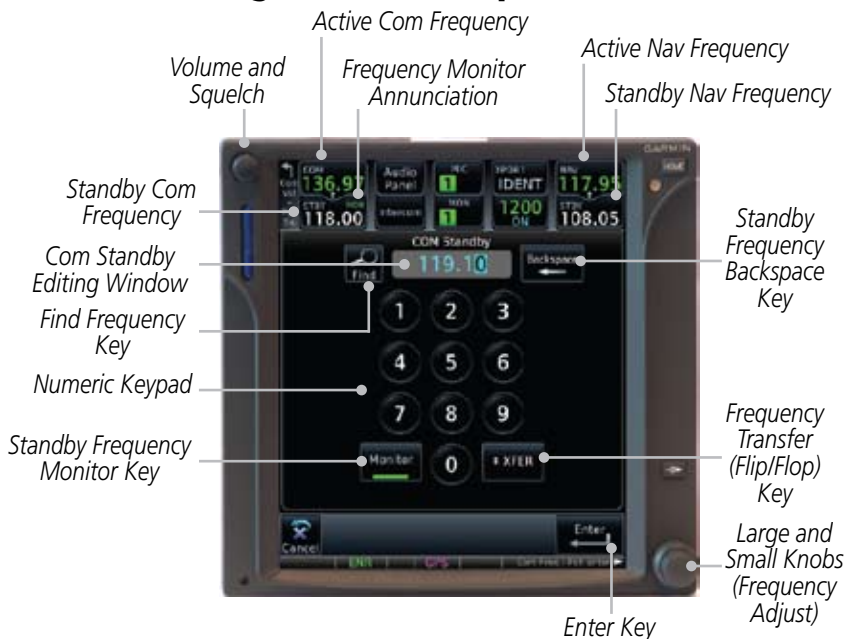

Figure 1-18 Com Radio Frequency Selection Page

### To switch between Com and Nav frequency selection

Tuning control normally remains in the Com window and will return after 30 seconds of inactivity. If you wish to select a VOR/localizer/ILS frequency, press the **small right** knob momentarily to make the Nav window active for editing. The Standby Nav frequency will be highlighted briefly to indicate that it is active for editing. The standby frequency in blue is active for editing by the **large** and **small right** knobs.

#### Method 1: Select a Nav/Com frequency using the small and large right rotary knobs



1. Turn the **large right** knob to select the desired megahertz (MHz) value. For example, the "118" portion of the frequency "118.30".
2. Turn the **small right** knob to select the desired kilohertz (kHz) value. For example, the ".30" portion of the frequency "118.30".
3. Touch the Com or Nav window to flip/flop the Active and Standby frequencies. You can also press and hold the **small right** knob to transfer the standby frequency to the active window.

## Method 2: Select a Nav/Com frequency using the numeric keypad

1. Touch the Standby window. A pull down keypad will appear with the current Standby frequency highlighted.
3. Touch the numeric keys to add the desired values and touch **Enter** to accept the displayed value and place it into the Standby window.
4. Touching the **XFER** key will place the selected frequency directly into the Active window.



## To transfer the standby frequency to the active frequency

1. Touch the Active (top) frequency window.



Figure 1-19 Com Radio Frequency Windows (Touch Active to Flip/Flop)

2. Each touch of the Active window will flip/flop the Active and Standby frequencies.

## 1.8 Flight Planning

### 1.8.1 Creating a Flight Plan

1. From the Home page, touch the **Flight Plan** key. The Active Flight Plan page will be displayed.
2. If there is already an Active Flight Plan, touch **Menu** and then the **Delete** key to clear the existing flight plan. If there is not an Active Flight Plan, continue to the next step.
3. Touch **Add Waypoint**. Use the alphanumeric keypad to select the Waypoint Identifier for the first leg in your flight plan and then touch **Enter**.
4. Touch the next Waypoint Identifier field. Use the alphanumeric keypad to select the Waypoint Identifier for the first leg in your flight plan and then touch **Enter**.





Store

5. Continue entering waypoints to complete the flight plan.
6. Touch the **Menu** key and then touch **Store**.

7. The screen will now display the Flight Plan Catalog and show the new flight plan. Flight plans are listed by the Departure and Destination waypoints.

## 1.9 IFR Procedures

Departures (SIDs), arrivals (STARs), non-precision and precision approaches are available using the **PROC** (Procedures) key.

### Select an Approach



1. Touch the **PROC** key on the Home page.



2. Touch the **Approach** key and then touch the Airport key to select the desired airport if it is not present.

3. Touch the **Approach** key, if necessary. Select the desired approach.



4. Touch the **Transition** key and then touch the key for the desired transition.

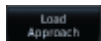

5. Touch the **Load Approach** key. The Active Flight Plan page will be displayed.



6. Activate or Load the approach. "Activate" will go Direct-To the IAF, or provide guidance on the final approach course for vectored approaches. "Load" places the approach at the end of the active flight plan.

## 1.10 Dead Reckoning

Dead reckoning is a feature that enables the GTN to provide limited navigation using the last known position and speed after a loss of GPS navigation while on an active flight plan.



**CAUTION:** *Navigation using dead reckoning is only an estimate and should not be used as the sole means of navigation. Use other means of navigation, if possible.*

Dead reckoning becomes active after a loss of GPS position while navigating using an active flight plan and the flight phase is either En Route (ENR) or Oceanic (OCN).

“DR” will be overlaid on the ownship icon. The To/From flag is removed from the CDI. The Dead Reckoning annunciator (DR) appears on the lower left side of the map display and will replace ENR or OCN when a GPS position is unavailable and the unit is in Dead Reckoning mode. All external outputs dependent on GPS position are flagged.

Terrain will be noted as not available and new terrain advisory pop-ups will not occur. Traffic and StormScope information will not be shown on the Map page, but will continue to be available on their own dedicated pages. XM weather will still be available on the Map page.

Dead Reckoning mode will continue until GPS position is restored, when GPS navigation is restored Dead Reckoning mode is exited. The DR annunciations will be removed and GPS information will be used to compute navigation related information for the current flight phase.

Dead Reckoning is only allowed in En Route and Oceanic phases of flight. If the unit is in a Terminal or Approach phase of flight when Dead Reckoning takes place, “No GPS Position” will be displayed on the map pages and all navigation data will be dashed. If you are operating in Dead Reckoning mode and a transition to Terminal or Approach phases of flight would occur from the projected Dead Reckoning position, Dead Reckoning mode will be discontinued. “No GPS Position” will be displayed on the map pages and all navigation data will be dashed.

Foreword

Getting Started

Audio & Xpdr Ctrl

Com/Nav

FPL

Direct-To

Proc

Charts

Wpt Info

Map

*This page intentionally left blank*

Traffic

Terrain

Weather

Nearest

Music

Utilities

System

Messages

Symbols

Appendix



## 2 AUDIO AND TRANSPONDER CONTROLS (OPTIONAL)

The GTN 7XX can perform the control and display for a remotely mounted audio panel (such as the GMA 35) and a transponder (such as one of the GTX family of transponders) functions. See your dealer for more information.

### 2.1 Transponder Operation

The GTN 7XX will operate as a control head for remotely connected optional, compatible transponders.



**Figure 2-1 XPDR Control Display**

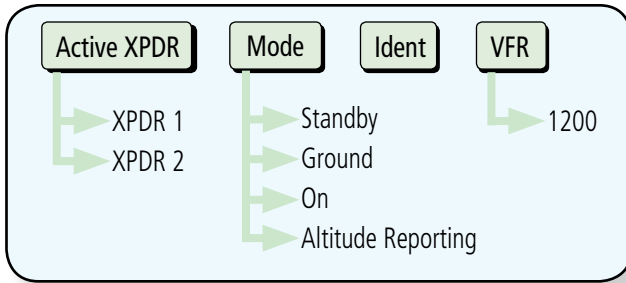

Figure 2-2 XPDR Functional Diagram

## 2.1.1 Select Transponder

1. Touch the **Active XPDR** key to activate the desired transponder by stepping through the available transponders.



Figure 2-3 Active Transponder Indication

2. The active transponder will be shown on the key.

## 2.1.2 IDENT

1. Touch the **IDENT** key once to reply with an identifying squawk code.
2. The **IDENT** key text will change to green to indicate active Ident.

## 2.1.3 Standby

1. Touch the **Standby** key to place the transponder into Standby mode. The transponder will still be powered, but will not transmit information. The active transponder indication and Ident annunciation will be grayed out to show they are disabled.

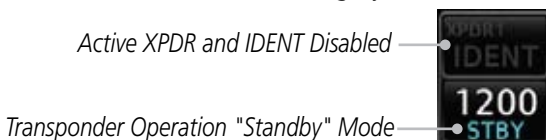

Figure 2-4 Transponder Mode "Standby" Indication

## 2.1.4 Ground



1. Touch the **Ground** key to place the transponder into Ground mode. Mode S replies will be allowed in Ground mode.

*Active XPDR and IDENT Enabled*

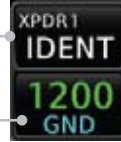

*Transponder Operation "Ground" Mode*

**Figure 2-5 Transponder Mode "Ground" Indication**

## 2.1.5 On

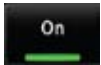

1. Touch the **On** key for Mode A operation. The transponder is "On" and will transmit its squawk code when interrogated.

*Transponder Operation "ON" Mode*



**Figure 2-6 Transponder Mode "ON" Indication**

## 2.1.6 Altitude Reporting



1. Touch the **Altitude Reporting** key for Mode C operation.
2. The transponder will be "On" and will transmit its squawk code and altitude when interrogated. An "ALT" annunciation will appear when the squawk code is transmitted.

## 2.1.7 VFR



Touch the **VFR** key to set the VFR squawk code (1200).

*VFR (1200) Transponder Squawk Code*



**Figure 2-7 Transponder VFR Squawk Code**

## 2.1.8 Selecting a Squawk Code

The selected squawk code will always be in use. As you change a squawk code, the original code will be used until you are finished selecting the new code.

Squawk Code	Description
1200	Default VFR code in the USA
7500	Hijacking
7600	Loss of Communications
7700	Emergency

**Table 2-1 XPDR Special Squawk Codes**

1. Touch the transponder squawk code window at the top of the display.
2. The XPDR page will be displayed. The Squawk Code value will be active for selection for use by the active Transponder.



**Figure 2-8 XPDR Squawk Code Selection Display**

3. Touch the numeric keypad, or use the rotary knobs, to select the desired Squawk Code.



Figure 2-9 Selected XPDR Squawk Code

4. Then, touch **Enter** or press the **small right** knob.



5. The selected Squawk Code will be shown in the XPDR window at the top of the display.



## 2.2 Audio Panel Operation

The GTN 7XX will operate as a control head for remotely connected optional, compatible audio and intercom equipment (such as the Garmin GMA 35).

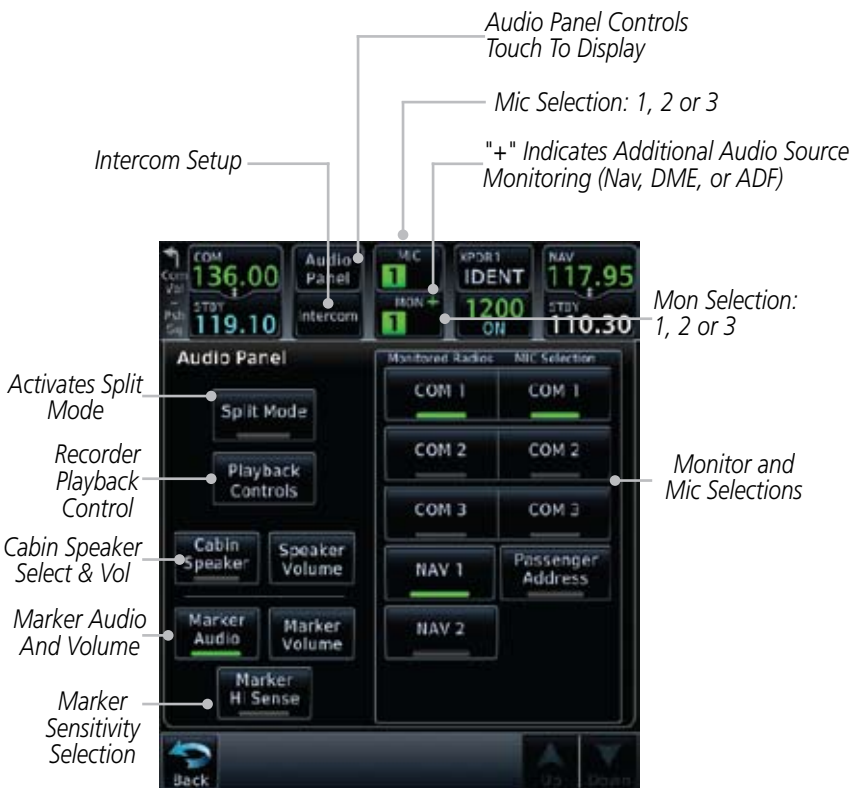

**Figure 2-10 Audio Panel Controls**

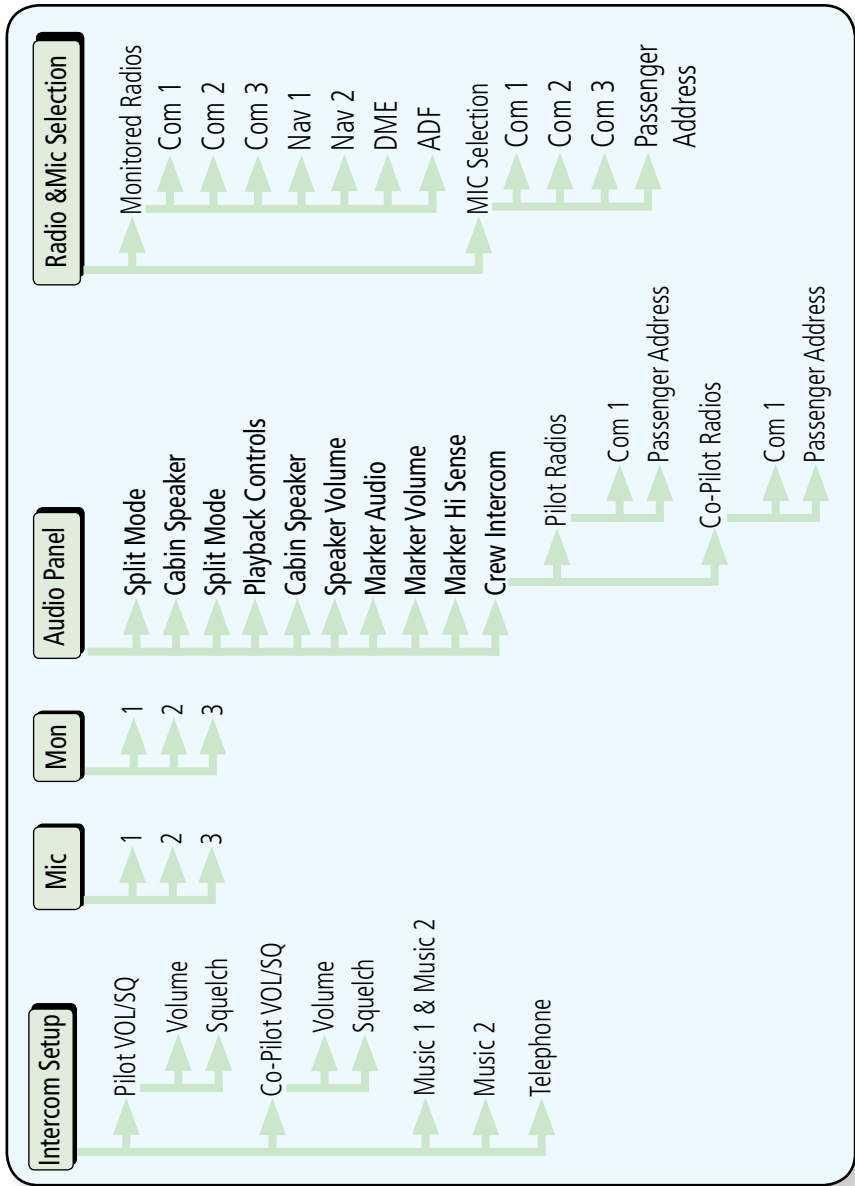

Figure 2-11 Audio Panel Functional Diagram

## 2.2.1 Mic Selection

Mic selection can be determined by two methods: the Mic window or by the Audio Panel page.

### 2.2.1.1 Mic Window Mic Selection



1. Touch the **Mic** window to toggle between Mic 1 and Mic 2.



2. Note that the selected Mic is automatically monitored.

3. If Mic 3 or Passenger Address (PA) are selected, touching the Mic window will revert to toggling between Mic 1 and Mic 2.

### 2.2.1.2 Audio Panel Page Mic Selection



1. Touch the **Audio Panel** key at the top of the display.

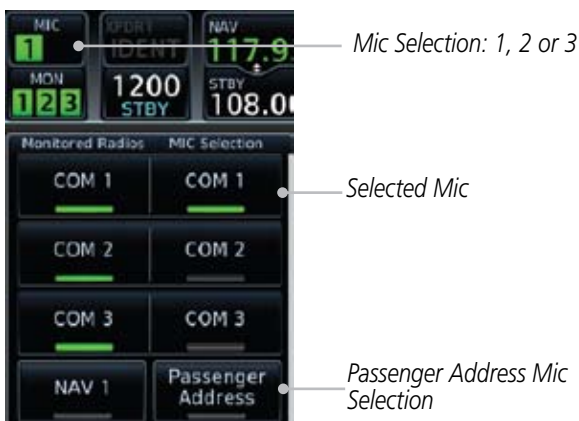

**Figure 2-12 Audio Panel MIC Selection**

2. Touch the desired Mic (Com 1, Com 2, or Com 3) from the MIC Selection list on the right side of the display.

3. The selected Mic will be shown in the Mic window.



## 2.2.2 Monitor

The Monitor function indicates which radios are being listened to.



1. Monitor is automatically selected for the associated Com Mic Radio (1, 2, or 3). For example, when Com 1 is selected, Mon 1 is automatically active.



2. Touch the **Mon** key to toggle between the automatically selected monitored channel (selected Mic) and the other channels.

## 2.2.3 Passenger Address

The **Passenger Address** key toggles the passenger address system on and off.



1. Touch the **Passenger Address** key to toggle the passenger address system on and off.

## 2.2.4 Cabin Speaker Selection and Volume

The **Cabin Speaker** key turns the cabin speaker on and off. The **Speaker Volume** key sets the volume level.

1. Touch the **Cabin Speaker** key to toggle the cabin speaker on and off.
2. Touch the **Speaker Volume** key to set the Cabin Speaker volume. Touch the **Speaker Volume** arrows to set the volume.

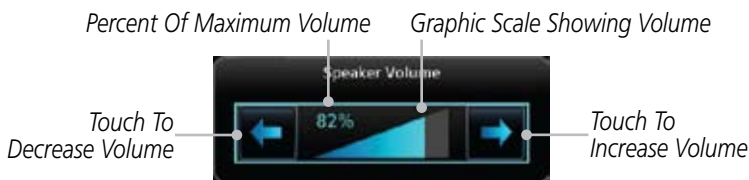

Figure 2-13 Cabin Speaker Volume Selection

## 2.2.5 Marker Audio and Volume

The optional Marker Beacon Receiver uses an audio indicator to alert you when the aircraft passes over a Marker Beacon transmitter. The audio from the Marker Beacon Receiver can be heard unless disabled by selecting Marker Audio. When Marker is selected (green bar shown), the tones for Marker Beacons are heard. When Marker is not selected (green bar not shown), the tones for Marker Beacons are not heard.

The GMA 35 marker beacon receiver and indicators are part of the ILS system. The marker beacon lamps operate independently of any audio selection and cannot be turned off. The GMA 35 can drive external marker lamps if required and also provides an autopilot middle marker sense output.

Prior to beginning an ILS approach, select high or low marker sensitivity with the **Marker Hi Sense** key. The lighted green bar in the key illuminates for high sensitivity and remains off for low sensitivity.

Touching the **Marker Audio** key prior to an approach allows the marker audio tones to be heard in the headsets. When the green bar in the **Marker Audio** key shows, the marker audio will be heard when available. The **Audio Panel** key will change to a **Mute** key. Touching the Mute key while audio is heard will mute the marker audio until the next beacon is received. The marker beacon signal sensitivity threshold can be set in Configuration mode. Contact a Garmin-authorized service center for adjustment.



1. While the Audio Control page is displayed, touch the **Marker Audio** key to hear the current Marker Beacon tones.



2. Touch the **Marker Audio** key again to disable Marker Beacon tones.

3. Touch the **Marker Volume** key to set the Marker Beacon tone volume. Touch the **Marker Volume** arrows to set the volume.

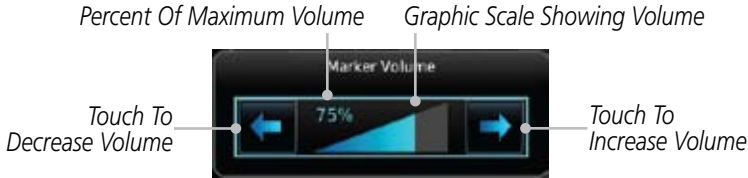

**Figure 2-14 Audio Panel Marker Beacon Tone Volume Selection**

## 2.2.6 Marker Hi Sense

The Marker Hi Sense setting allows detecting the outer Marker Beacon from a greater distance.



1. While the Audio Control page is displayed, touch the **Marker Hi Sense** key to activate greater Marker Beacon sensitivity.



2. Touch the **Marker Hi Sense** key again to return to normal sensitivity.

## 2.2.7 Marker Beacon Annunciations

A visual annunciation of marker beacons will be shown on the display when the aircraft flies over a marker beacon. The annunciation will appear in the lower left of the display.

Current Beacon	Icon (Standard)	Icon (Blink)	Blink Interval
Inner Marker			250 ms
Middle Marker			333 ms
Outer Marker			750 ms

The marker beacon alternates between the standard icon and the blink icon at the blink interval corresponding to the current beacon.

**Table 2-2 Marker Beacons**

## 2.2.8 Audio Split Mode

In Split Mode the pilot uses one radio for MIC audio while the copilot uses a different radio. The pilot and copilot can transmit simultaneously over separate radios. The pilot can still listen to their individually selected radios. In the Split mode, the pilot and co-pilot may talk and listen independently to the radios (or PA) as selected.



**Figure 2-15 Audio Panel Split Mode Controls**

1. While the Audio Control page is displayed, touch the **Split Mode** key to display the Crew Intercom selections.
2. Touch the **Split Mode** key again to toggle the Crew Intercom selection off.
3. Touch the **Crew Intercom** key to toggle activation of the Crew Intercom allowing the Pilot and Co-Pilot to talk to each other.
4. Touch the desired Pilot and Co-Pilot Radio selections.



## 2.2.9 Playback Controls

The voice recorder feature records all the audio heard on any selected COM radio. Playback is heard by anyone listening on the selected radios.

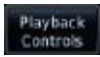

1. While the Audio Control page is displayed, touch the **Playback Controls** key to display the Playback Control selections.



**Figure 2-16 Audio Panel Playback Controls**

2. Touch the **Playback Volume** arrows to set the volume.
3. Touch the **Backward**, **Play**, or **Forward** keys to control the playback of the currently selected recording.

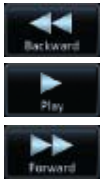

4. Touch the **Previous** or **Next** keys to select a recording.



5. Touch the **Back** key to return to the Audio Panel page.



## 2.3 Intercom Setup

The GTN 7XX will operate as a control head for remotely connected optional, compatible intercom equipment. The Intercom (ICS) System has several modes of operation that are selected on the display of the GTN 7XX to control communication in the aircraft. Passengers cannot transmit over the active Com radio, even if equipped with a PTT key.





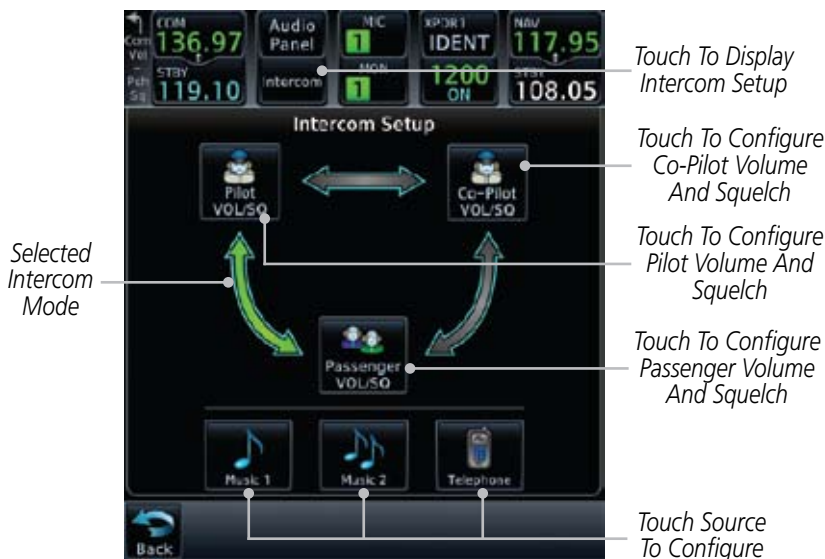



1. Touch the **Intercom** window at the top of the display to display the Intercom Setup page.



**Figure 2-17 Intercom Setup**

2. Touch the arrow between the intercom recipients to activate communication between those recipients. The arrow will be green when communication is active. Touch the arrow again to deactivate communication. Detailed information is shown in the Intercom Modes table.
3. Touch the key for a function to make the desired changes to their configuration. Then, touch the **Back** key to return to the Intercom Setup page.

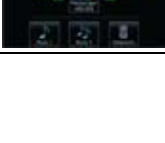

Mode	Pilot Hears	Co-Pilot Hears	Passengers Hear
	Selected radios, pilot	Selected radios, co-pilot	Passengers
	Selected radios, pilot, co-pilot	Selected radios, pilot, co-pilot	Passengers
	Selected radios, pilot, co-pilot	Selected radios, co-pilot, pilot, passengers	Co-pilot, passengers
	Selected radios, pilot, passengers	Selected radios, co-pilot	Pilot, passengers
	Selected radios, pilot	Selected radios, co-pilot, passengers	Co-pilot, passengers
	Selected radios, pilot, co-pilot, passengers	Selected radios, pilot, co-pilot	Selected radios, pilot, passengers
	Selected radios, pilot, passengers	Selected radios, co-pilot, passengers	Selected radios, pilot, co-pilot, passengers
	Selected radios, pilot, co-pilot, passengers	Selected radios, pilot, co-pilot, passengers	Selected radios, pilot, co-pilot, passengers

**Table 2-3 Intercom Modes**

Foreword

Getting Started

Audio & Xpdr Ctrl

Com/Nav

FPL

Direct-To

Proc

Charts

Wpt Info

Map

Traffic

Terrain

Weather

Nearest

Music

Utilities

System

Messages

Symbols

Appendix

- Foreword
- Getting Started
- Audio & Xpdr Ctrl**
- Com/Nav
- FPL
- Direct-To
- Proc
- Charts
- Wpt Info
- Map
- Traffic
- Terrain
- Weather
- Nearest
- Music
- Utilities
- System
- Messages
- Symbols
- Appendix

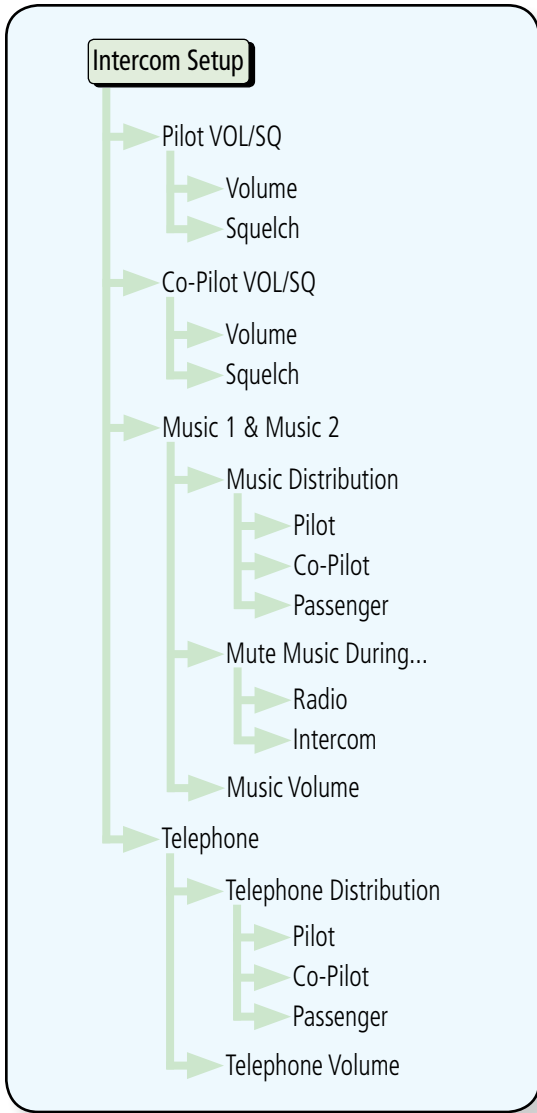
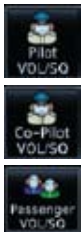

**Figure 2-18 Intercom Setup Functional Diagram**



## 2.3.1 Set Pilot, Co-Pilot, & Passenger Volume and Squelch

In the Intercom Setup function, the Volume and Squelch may be set separately for the Pilot, Copilot, and Passenger intercoms.



1. While viewing the Intercom Setup page, touch the **Pilot, Co-Pilot, or Passenger VOL/SQ** keys to set the Volume and Squelch for the selected item.

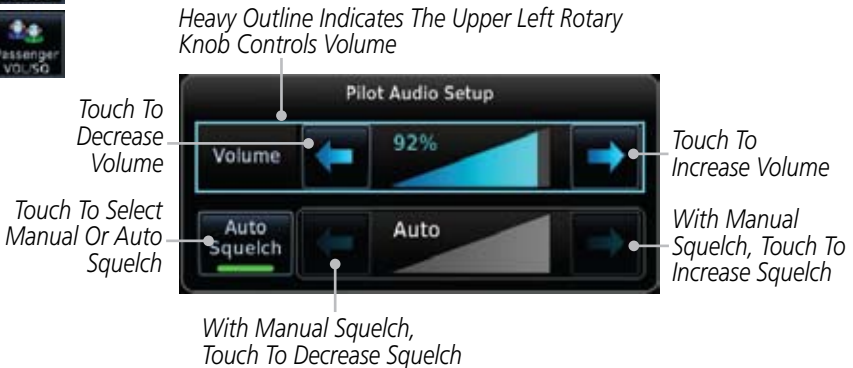

**Figure 2-19 Pilot Audio Setup**

2. Touch the **Volume** arrows to set the desired Volume level.
3. Touch the **Auto Squelch** key to allow the unit to set the Squelch level automatically. When enabled, the **Auto Squelch** key will display a green bar.
4. Touch the **Squelch** arrows to set the desired Squelch level.
5. Touch the **Back** key to return to the Intercom Setup page.



## 2.3.2 Music 1 and Music 2 Configuration

In the Intercom Setup function and Volume may be set separately for up to two music sources.

1. While viewing the Intercom Setup page, touch the **Music 1** or **Music 2** keys to set their configuration.

*Heavy Outline Indicates The Upper Left Rotary Knob Controls Volume*

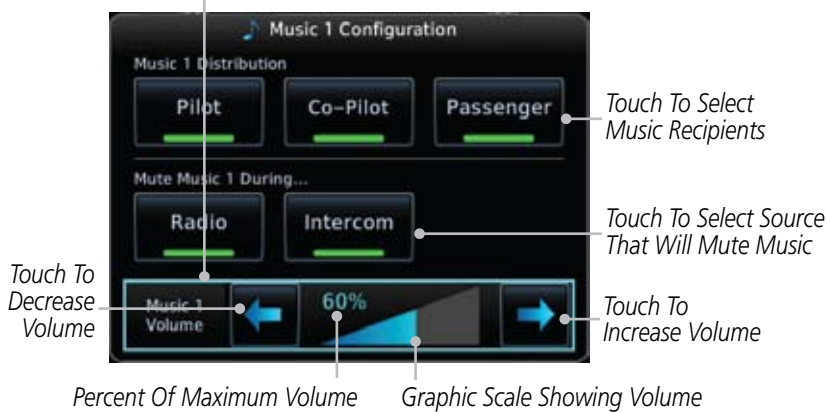

**Figure 2-20 Music 1 Configuration**

2. Select the recipients for Music Distribution by touching any combination of the **Pilot**, **Co-Pilot**, or **Passenger** keys.
3. Touch the **Radio** and/or **Intercom** keys to select the function that when active Music will be muted.
4. Touch the **Volume** arrows to set the desired Volume level.

---

**NOTE:** At every power cycle, the "mute music during radio" selection will be active.

---



## 2.3.3 Telephone Configuration

The GMA 35 provides a 2-way telephone interface. Operation depends on the state of the **TEL** key and ICS mode. Telephone communication is much like using the intercom, allowing both parties to talk at once.

The TEL channel may be disabled in Configuration mode. Contact a Garmin-authorized service center for details.



1. While viewing the Intercom Setup page, touch the **Telephone** key to set its configuration.

*Heavy Outline Indicates The Upper Left Rotary Knob Controls Volume*

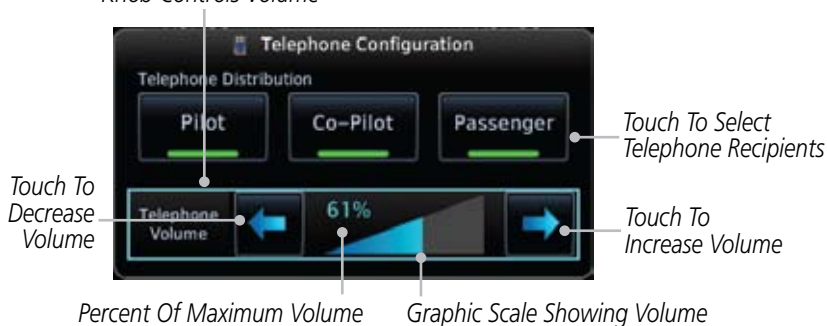

**Figure 2-21 Telephone Configuration**

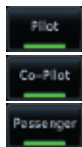

2. Select the recipients for Telephone Distribution by touching any combination of the **Pilot**, **Co-Pilot**, or **Passenger** keys.
3. Touch the **Volume** arrows to set the desired Telephone Volume level.

Foreword

Getting  
Started

Audio &  
Xpdr Ctrl

Com/Nav

FPL

Direct-To

Proc

Charts

Wpt Info

Map

*This page intentionally left blank*

Traffic

Terrain

Weather

Nearest

Music

Utilities

System

Messages

Symbols

Appendix

## 3 NAV/COM

### (GTN 750 NAV/COM)

The GTN 750 features a digitally-tuned VHF Com radio that provides a seamless transition from communication to navigation. The GTN 750's Com radio operates in the aviation voice band, from 118.000 to 136.975 MHz, in 25 kHz steps (default). For European operations, a Com radio configuration of 8.33 kHz steps is also available.



Figure 3-1 Nav/Com Controls

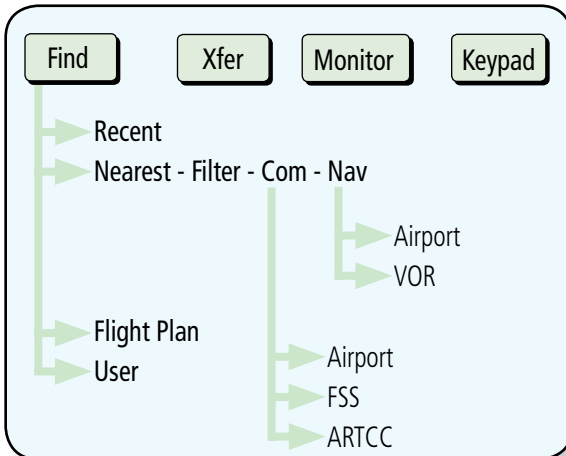

Figure 3-2 Nav/Com Functional Diagram

### 3.1 Volume

Com radio volume is adjusted using the **Volume** knob. Turn the **Volume** knob clockwise to increase volume, or counterclockwise to decrease volume. The level will be maintained until changed or power is cycled.

1. Turn the **Volume** knob to set the Com volume.



*Percent Of Maximum Volume      Graphic Scale Showing Volume*

**Figure 3-3 Com Volume Setting**

2. A bar graph showing the relative volume level will indicate the selected level and will disappear a few seconds after releasing the **Volume** knob.

### 3.2 Squelch

The Com radio features an automatic squelch to reject many localized noise sources. You may override the squelch function by pressing the **Volume** knob. This facilitates listening to a distant station or setting the desired volume level.

To override the automatic squelch, press the **Volume** knob momentarily. Press the **Volume** knob again to return to automatic squelch operation. A “SQ” indication appears above the active Com frequency window in the upper left corner of the display when automatic squelch is overridden.

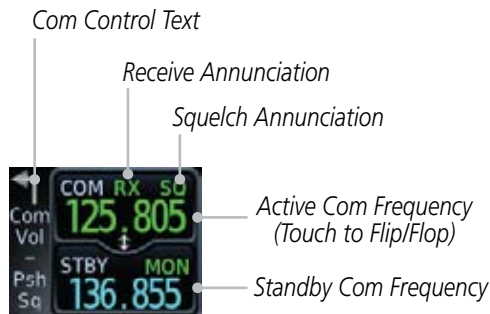

**Figure 3-4 Com Controls**

While receiving a station, an “RX” indication appears in the Com frequency window to the immediate right of “Com.” A “TX” indication appears at this location while you are transmitting.

## 3.3 Com Window and Tuning

Communication frequencies are selected by using the **large** and **small right** knobs or by touching the value in the *standby* Com frequency field and using the subsequent keypad. The standby frequency always appears below the active frequency. The active frequency is the frequency currently in use for transmit and receive operations.

Once a frequency is selected in the standby field, it may be transferred to the active frequency by touching the active frequency field.



**NOTE:** *The Com window is normally active for adjustment, unless the NAV window is made active by pressing the **small right** knob. The active state automatically returns to the Com window after 30 seconds of inactivity.*

### To select a Com frequency using the small and large right knobs:



1. If the tuning cursor is not currently in the Com window, press the **small right** knob momentarily. The Standby Com frequency will be highlighted to indicate that it is active for editing.
2. Turn the **large right** knob to select the desired megahertz (MHz) value. For example, the "118" portion of the frequency "118.30".
3. Turn the **small right** knob to select the desired kilohertz (kHz) value. For example, the ".30" portion of the frequency "118.30".

## To select a Com frequency using the numeric keypad:

1. Touch the Standby window.
2. A pull down keypad will appear with the current Standby frequency highlighted.



Figure 3-5 Com Standby Frequency Numeric Keypad

3. Touch the numeric keys to add the desired values and touch **Enter** to accept the displayed value and place it into the Standby Com window.
4. Touching the **Xfer** key will place the selected frequency directly into the Active window.



## To make the standby frequency the active frequency:

1. Touch the Com active frequency (top) window.
2. The Active (top) and Standby frequencies will flip/flop.





## 3.3.1 Com Frequency Finding

The GTN 750's frequency finding feature allows you to quickly select any displayed database Com frequency as your standby frequency. The following are some examples of selecting Com frequencies from some of the main GPS pages.

**To select a Com frequency for a User created frequency, Recent selected frequency, Nearest airport, or from your Flight Plan:**



1. While viewing the numeric keypad touch the **Find** key. Categories for User, Recent, Nearest, and Flight Plan are available.



2. Touch **Recent, Nearest, Flight Plan, or User**. A list of frequencies for the Nearest airports will be displayed.



*Selected Frequency Category*

*Selected Frequency for Nearest Airport*

*Touch to Select Nearest List*

**Figure 3-6 Com Nearest Airport Frequency**

3. Touch the desired Com frequency to select it and place it into the Com Standby window of the numeric keypad display.

Foreword  
Getting Started  
Audio & Xpdr Ctrl  
Com/Nav  
FPL  
Direct-To  
Proc  
Charts  
Wpt Info  
Map  
Traffic  
Terrain  
Weather  
Nearest  
Music  
Utilities  
System  
Messages  
Symbols  
Appendix

### 3.3.1.1 Find Recent Frequencies

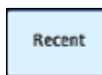

1. While viewing the **Find** results, touch the **Recent** tab. A list of the recently selected frequencies will be displayed.

Recent Frequency Category



Selected Frequency Category

Touch Frequency From Recent List To Select Standby Frequency

Figure 3-7 Recent Com Frequency List

2. Touch the desired frequency to select it and place it into the Standby window.

### 3.3.1.2 Find Nearest Frequencies



1. While viewing the **Find** results, touch the **Nearest** key. A list of the nearest airport Com frequencies will be displayed.

Selected Frequency Category



Selected Frequencies For Nearest Airport

Figure 3-8 Com Nearest Airport Frequency



2. Touch the **Multiple FREQ** key to show the available frequencies.



*Touch A Frequency Key To Place It In The Standby Window*

**Figure 3-9 Nearest Airport Multiple Frequency List**



3. Touch the **Filter** key to filter the Nearest List by Airports, FSS, or ARTCC.



**Figure 3-10 Nearest Com Frequency List**

4. Touch the desired Frequency List. Then, touch the desired frequency to load it into the Standby window.

- Some frequencies will have more information detail available. Touch the key that shows "More Information."

Foreword  
Getting Started  
Audio & Xpdr Ctrl  
**Com/Nav**  
FPL  
Direct-To  
Proc  
Charts  
Wpt Info  
Map  
Traffic  
Terrain  
Weather  
Nearest  
Music  
Utilities  
System  
Messages  
Symbols  
Appendix



**Figure 3-11 More Information Is Available For Some Frequencies**

- More detailed information is shown on the display. Touch the frequency to load it into the Standby window.



**Figure 3-12 More Frequency Detail**

## 3.3.1.3 Find Flight Plan Frequencies



1. While viewing the **Find** results, touch the **Flight Plan** tab. A list of Com or Nav frequencies associated with the active flight plan will be displayed.

Selected Frequency Category

Selected Frequency Category



Touch To Select Frequency From List For Nearest Airport

Figure 3-13 Flight Plan Frequency List



2. Touch the **Multiple FREQ** key to show the available frequencies, if present.
3. Touch the desired frequency to select it and place it into the Standby window.

## 3.3.1.4 Find User Frequencies



1. While viewing the **Find** results, touch the **User** tab. A list of User-created frequencies will be displayed.
2. Touch the desired frequency to load it into the Standby window.

## 3.3.2 Adding a New User Frequency



1. While viewing the numeric keypad touch the **Find** key at the bottom of the display.



2. Touch the **User** tab and then touch the **Add User Frequency** key.

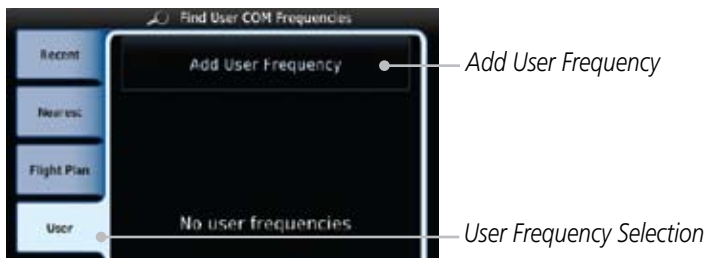

**Figure 3-14 Add New User Frequency**

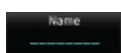

- The Add New User Frequency information window will now be displayed. Touch the **Name** key to select a name for the User frequency.

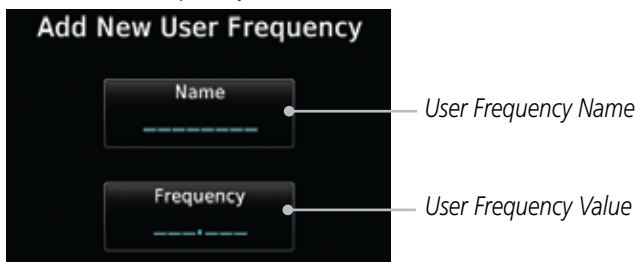

**Figure 3-15 Add New User Frequency Detail Window**



4. Select the characters from the alphanumeric keypad for the desired name. Touch the **Enter** key to accept the displayed Name.



Figure 3-16 Select a Name for the New User Frequency



5. Touch the **Frequency** key and select the characters from the keypad for the desired frequency. Touch the **Enter** key to accept the displayed frequency.



Figure 3-17 Select a Frequency Value for the New User Frequency



6. Touch the **Enter** key to accept the displayed name and frequency. The new User Frequency will be added to the list.

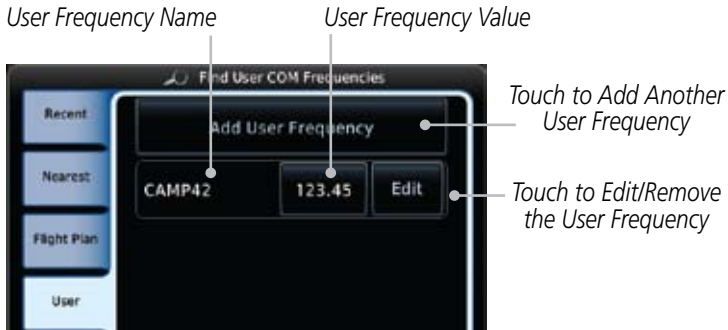

Figure 3-18 Completed New User Frequency

### 3.3.3 Emergency Frequency

The GTN 750's emergency frequency select provides a quick method of selecting 121.50 MHz as the active frequency in the event of an in-flight emergency. The emergency frequency select is available whenever the unit is on, regardless of GPS or cursor status, or loss of the display.



To quickly tune and activate 121.50, press and hold volume knob or the remote Com flip-flop key for approximately two seconds. If the external remote key is used, further changes in Com frequency will not be possible until the external remote switch is pressed again for two seconds.



**NOTE:** Under some circumstances if the Com system loses communication with the main system, the radio will automatically tune to 121.50 MHz for transmit and receive regardless of the displayed frequency.

### 3.3.4 Stuck Microphone

Whenever the GTN 750 is transmitting, a “TX” indication appears in the Com window. If the push-to-talk key on the microphone is stuck or accidentally left in the keyed position, or continues to transmit after the key is released, the Com transmitter automatically times out (or ceases to transmit) after 30 seconds of continuous broadcasting. You will also receive a “Com push-to-talk key stuck” message as long as the stuck condition exists.



### 3.3.5 Remote Frequency Selection Control

On units configured for remote Com frequency Recall, pressing the remote recall switch will load the next preset Com frequency into the unit's Standby frequency box. The remote recall switch can be pressed multiple times to scroll the entire preset frequency list through the Standby frequency box (the list will “wrap” from the bottom of the list back up to the top, skipping any empty preset positions).

The standby frequency isn't activated until a Com flip-flop switch (either remote- or bezel-mounted) is pressed. Remote Frequency Selection only functions on units configured for a remote Com Frequency recall switch.

Foreword

Getting Started

Audio &amp; Xpdr Ctrl

**Com/Nav**

FPL

Direct-To

Proc

Charts

Wpt Info

Map

Traffic

Terrain

Weather

Nearest

Music

Utilities

System

Messages

Symbols

Appendix

## 3.4 Com Frequency Monitoring

The Frequency Monitoring function allows you to listen to the Standby frequency in the Com radio, while monitoring the Active frequency for activity.

1. Touch the **Monitor** key to listen to the standby frequency. A small "MON" annunciation is displayed to the right of the Standby frequency. A green bar will show on the **Monitor** key. When the Active frequency receives a signal, the unit will switch automatically to the Active frequency and then switch back to the standby frequency when activity ceases.



Figure 3-19 Com Frequency Monitoring

2. The Monitor function is deactivated when you touch the **Monitor** key again and the green bar is extinguished.



**NOTE:** The Com radio Monitoring function is different than the Monitor function of the Audio Panel.

### 3.5 NAV (VOR/Localizer/Glideslope) Receiver Operations

The GTN 750 includes digitally-tuned Nav/localizer and glideslope receivers with the desired frequency selected on the *Nav window*, along the top right-hand side of the display. Frequency selection is performed by pressing the **small right knob** to activate Nav Standby frequency editing and then turning the **small** and **large right** knobs or keypad to select the desired frequency.

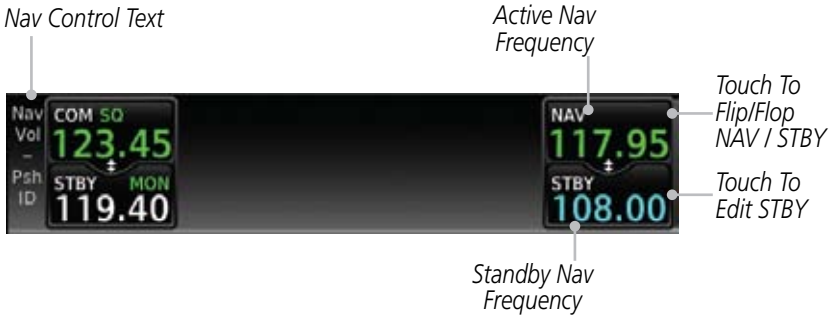

**Figure 3-20 Nav Frequency Window**

#### 3.5.1 Ident Audio and Volume

Nav ident is enabled by pressing the **Volume** knob when the Nav window is active. When Nav ident is enabled, the ID annunciation will appear in the active Nav window. When the Nav function is enabled, the Nav Standby channel window will highlight briefly and then turn to blue text. The Nav Standby frequency will be active for editing for about 30 seconds before the Com Standby frequency becomes active for editing.

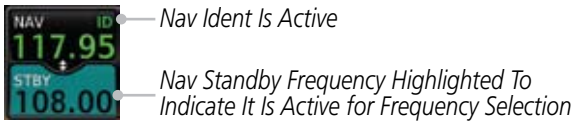

**Figure 3-21 Nav Standby Frequency Window and Ident is Active**

Nav audio volume is adjusted using the **Volume** knob. Turn the **Volume** knob clockwise to increase volume, or counterclockwise to decrease volume.

## 3.5.2 Nav Tuning Window

Nav frequencies are selected with the tuning cursor in the standby Nav frequency field, and using the **small** and **large right** knobs to dial in the desired frequency. The keypad may also be used for frequency entry after touching the Standby window. The standby frequency always appears below the active frequency. The active frequency is the frequency currently in use.



**NOTE:** *Tuning is normally active in the Com window, unless placed in the Nav window by pressing the **small right** knob. When the tuning cursor is in the Nav window, it automatically returns to the Com window after 30 seconds of inactivity. The active frequency in either window cannot be accessed directly — only the standby frequency is active for editing.*

### To select a VOR/localizer/ILS frequency:



1. Touch the **small right** knob momentarily to make the Nav Standby frequency value active for editing. The window will be highlighted momentarily.
2. Turn the **large right** knob to select the desired megahertz (MHz) value. For example, the “117” portion of the frequency “117.80”.
3. Turn the **small right** knob to select the desired kilohertz (kHz) value. For example, the “.80” portion of the frequency “117.80”.
4. Touch the Nav active (top) frequency to make the standby frequency.
5. The Active (top) and Standby frequencies will switch.



## 3.5.3 Nav Frequency Finding

The GTN 750's frequency finding feature allows you to quickly select any displayed database Nav frequency as your standby frequency.

To select a Nav frequency for a User created frequency, Recent selected frequency, Nearest airport, or from your Flight Plan:



1. While viewing the numeric keypad touch the **Find** key at the bottom of the display. Categories for User, Recent, Nearest, and Flight Plan are available.



2. Touch the **User, Recent, Nearest, or Flight Plan** key. A list of frequencies for the Nearest airports will be displayed.



Nearest Nav Frequency List Is Selected

Active Nav Frequency Key

Touch To Select For Standby Nav Frequency

Nearest Nav Frequency List

Touch to Filter Nearest List

Figure 3-22 Nearest Airport Nav Frequency

3. Touch the desired Nav frequency to select it and place it into the Nav Standby window.

OR

4. Touch the **Filter** key to narrow the list by category, such as Airport and VOR, and then select a given frequency.

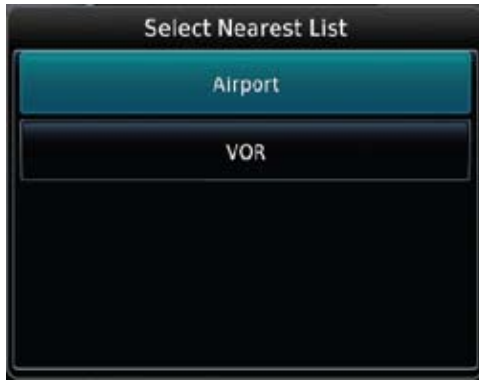

**Figure 3-23 Nearest Nav Frequency List**

- Foreword
- Getting Started
- Audio & Xpdr Ctrl
- Com/Nav**
- FPL
- Direct-To
- Proc
- Charts
- Wpt Info
- Map
- Traffic
- Terrain
- Weather
- Nearest
- Music
- Utilities
- System
- Messages
- Symbols
- Appendix

## 4 FLIGHT PLANS



The GTN 7XX lets you create up to 99 different flight plans, with up to 100 waypoints in each flight plan. The Flight Plan function is accessed by touching the **Flight Plan** key on the Home page. The Flight Plan function allows you to create, store, edit, and copy flight plans.

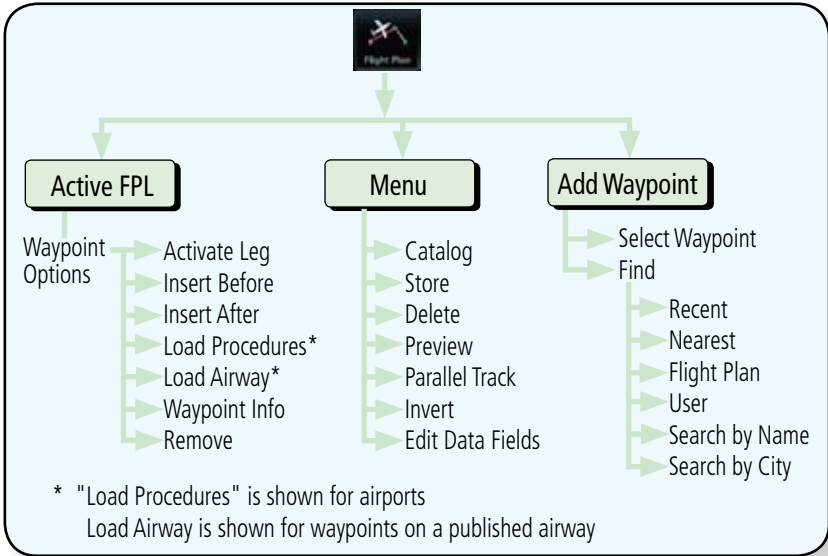

Figure 4-1 Flight Plan Functional Diagram



**NOTE:** The Chart feature provides a digital representation of a paper chart and provides no vertical or lateral course guidance. Flight Plan and Procedures are separate from Charts, and do provide vertical and lateral course guidance for the loaded route or procedure shown on the Flight Plan page. The term “Chart Unavailable” means that the chart cannot be viewed on the Charts due to either a chart not being published, or an error in the Chart database, but does not preclude its availability or inclusion of the procedure in the Flight Plan or Procedures portion of the system. The absence of a chart for a particular Departure, Arrival, or Approach does not preclude its availability or inclusion in the Flight Plan or Procedures portion of the system. The absence of a particular Departure, Arrival, or Approach under the Flight Plan or Procedures portion of the system does not preclude the ability to view the Chart for that procedure under the Chart feature.

## 4.1 Creating a New Flight Plan

### 4.1.1 Creating a New Flight Plan in the Catalog

1. From the Home page, touch **Flight Plan**.
2. Touch **Menu** and then the **Catalog** key.
3. Touch the **Create New Catalog Route** key at the end of the flight plan list in the Catalog.



Create New Catalog Route



Touch To Create New Flight Plan

Figure 4-2 Create a New Catalog Route (Flight Plan)

4. Touch the **Add Waypoint** key and select a waypoint identifier with the alphanumeric keypad. Then, touch **Enter**.

Add Waypoint

Enter

Selected Flight Plan Waypoint



Figure 4-3 Select a Waypoint for the New Flight Plan



## 4.1.2 Creating a New Flight Plan from the Active Flight Plan



1. From the Home page, touch **Flight Plan**.



Figure 4-4 Create New Flight Plan by Clearing Active Flight Plan



2. If there is already an Active Flight Plan, touch **Menu** and then the **Delete** and **OK** keys to delete the existing active flight plan. The stored flight plan in the Catalog will not be deleted.



3. Touch the **Add Waypoint** key and select a waypoint identifier with the alphanumeric keypad. Then, touch **Enter**.



4. Touch the **Add Waypoint** key and select the waypoint identifier with the keypad for the next waypoint. Touch **Enter**.



5. Continue adding waypoints as needed.



6. Touch **Menu** and then touch **Store** to store the flight plan in the Catalog. The screen will now display the Flight Plan Catalog and show the new flight plan. Flight plans are listed by the Departure and Destination waypoints.



## 4.2 Active Flight Plan Page

The Active Flight Plan Page provides information and editing functions for the flight plan currently in use for navigation. Once you have activated a flight plan, the Active Flight Plan Page shows each waypoint for the flight plan, along with the Desired Track (DTK), Distance (DIST) for each leg and Cumulative Distance (CUM). The data fields are user-selectable and may be changed to display Cumulative Distance (CUM), Distance (DIST), Desired Track (DTK), En Route Safe Altitude (ESA), or Estimated Time of Arrival (ETA).

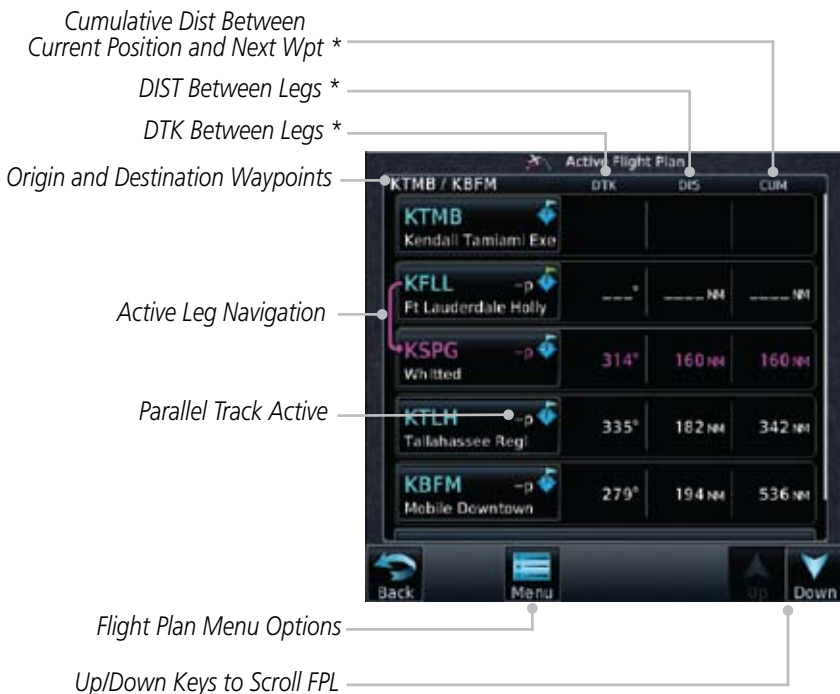

**Figure 4-5 Active Flight Plan Page**

\* The field types may be changed using the Edit Fields function in the Flight Plan page Menu.

## 4.2.1 Waypoint Options



1. While viewing the Active Flight Plan page, touch the desired flight plan waypoint. The Waypoint Options window will be shown.

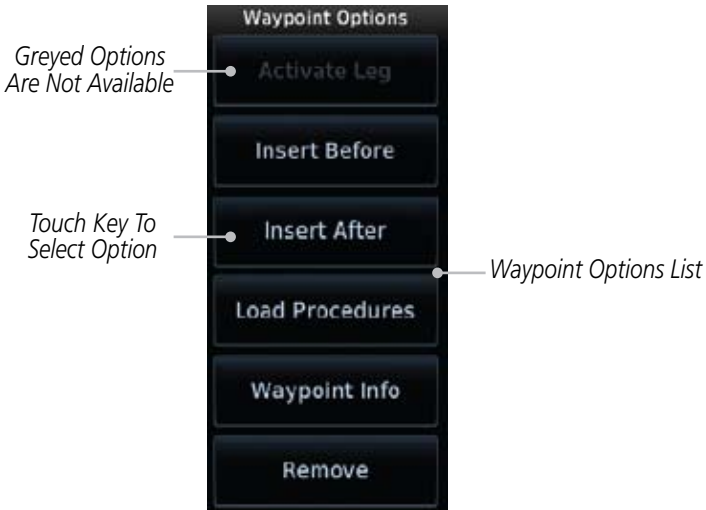

Figure 4-6 Active Flight Plan Wpt Options

2. Touch one of the options to perform the selected action. Cancel the option selection by touching the **Back** key.

### 4.2.1.1 Activate Leg

The Activate Leg option allows you to change the active leg of a flight plan.

Activate Leg

1. On the Waypoint Options menu, touch the desired TO waypoint and then the **Activate Leg** key to select the TO waypoint as the active leg for navigation.



Figure 4-7 Active Flight Plan Activate Leg Option

OK

2. Touch the **OK** key to set the selected leg as the Active Leg, or **Cancel** to not select it.

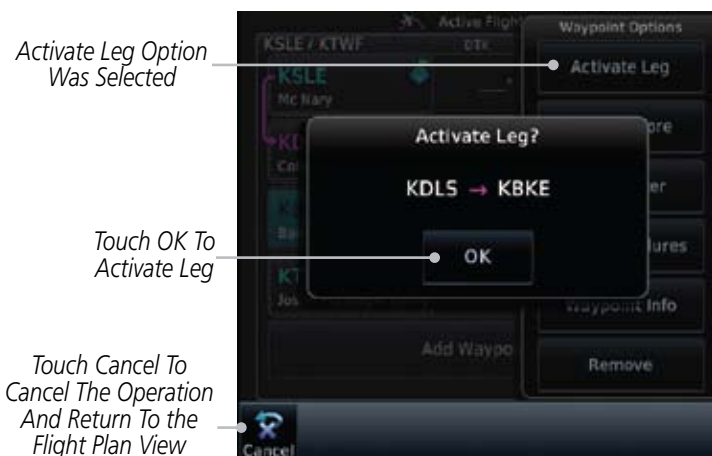

Figure 4-8 Active Flight Plan Activate Leg Option

## 4.2.1.2 Insert Before

The Insert Before option allows you to insert a new waypoint into the active flight plan before the selected waypoint.

1. On the Active Flight Plan page, touch the desired waypoint in the flight plan. The Waypoint Options list will be displayed.



**Figure 4-9 Active Flight Plan Insert Waypoint Before Option**

2. Touch the **Insert Before** key to select a new waypoint before the selected waypoint.
3. Select a waypoint identifier with the alphanumeric keypad.

*Choose New Waypoint To "Insert Before" The Selected Flight Plan Waypoint*



**Figure 4-10 Use the Alphanumeric Keypad to Select Waypoint to Insert Before**



- Then, touch **Enter** to confirm the selection, or touch **Cancel** to cancel any changes. The new flight plan will be shown.

*New  
Waypoint  
Inserted  
Before The  
Selected Flight  
Plan Waypoint*

Catalog Flight Plan			
KSLE / KTWF	DTK	DIS	CUM
KSLE Mc Nary			
<b>KTDT</b> Portland Troutdale	017°	46.1 NM	46.1 NM
KDLS Columbia Gorge Reg	069°	52.2 NM	98.2 NM
KBKE Baker City Mun	091°	150 NM	248 NM
KTWF Joslin Fld Magic Vall	118°	202 NM	450 NM

**Figure 4-11 New Waypoint Is Inserted Before the Selected Waypoint**

*Selected Flight  
Plan Waypoint*

*New Flight  
Plan Waypoint*



**Figure 4-12 Flight Plan Before and After New Waypoint Inserted**

## 4.2.1.3 Insert After

The Insert Before option allows you to insert a new waypoint into the active flight plan after the selected waypoint.

1. On the Active Flight Plan page, touch the desired waypoint in the flight plan. The Waypoint Options list will be displayed.
2. Touch the **Insert After** key to select a new waypoint after the selected waypoint.
3. Select a waypoint identifier with the alphanumeric keypad. Then, touch **Enter** to confirm the selection, or touch the **Cancel** key to cancel the operation and return to the Waypoint Options window.



## 4.2.1.4 Remove

The Remove option allows you to remove the selected waypoint from the active flight plan.

1. On the Active Flight Plan page, touch the desired waypoint in the flight plan. The Waypoint Options list will be displayed.
2. On the Waypoint Options menu, touch the **Remove** key to delete the selected waypoint from the active flight plan.

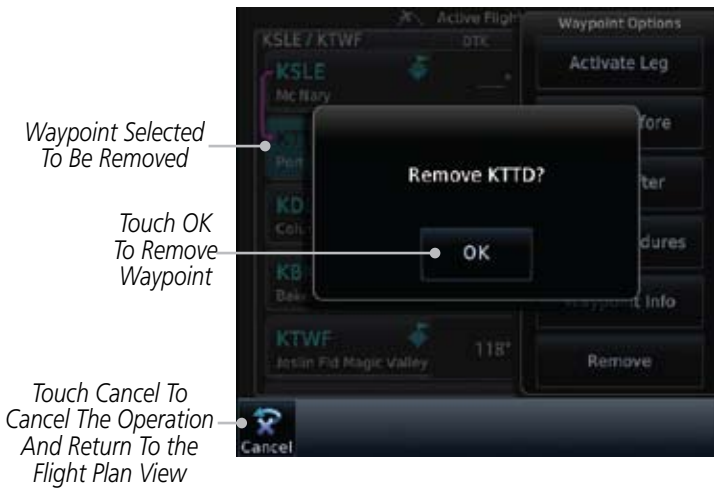

Figure 4-13 Active Flight Plan Remove Waypoint Option

## 4.2.1.5 Load Procedures

The Load Procedure selection from the Waypoint Options will start the Procedures function. See the Procedures section for complete information.

1. On the Active Flight Plan page, touch the desired waypoint in the flight plan. The Waypoint Options list will be displayed.
2. Touch the **Load Procedures** key to go to the Procedure function for adding procedures to the selected flight plan.

Load Procedures



*Touch to Select an Approach*

*Touch to Select an Arrival*

*Touch to Select a Departure*

**Figure 4-14 Load Procedures Wpt Option**

Foreword  
Getting Started  
Audio & Xpdr Ctrl  
Com/Nav  
FPL  
Direct-To  
Proc  
Charts  
Wpt Info  
Map  
Traffic  
Terrain  
Weather  
Nearest  
Music  
Utilities  
System  
Messages  
Symbols  
Appendix



## 4.2.1.6 Waypoint Info

The Waypoint Info option allows you to view information about the selected waypoint in the Waypoint Info function. See the Waypoint Info section for complete information.

1. On the Active Flight Plan page, touch the desired waypoint in the flight plan. The Waypoint Options list will be displayed.
2. One Waypoint Options menu, touch the **Waypoint Info** key to view information about the selected waypoint.

Waypoint Info



Figure 4-15 Active Flight Plan Wpt Info



3. Touch the **Back** key to return to the Active Flight Plan page.

## 4.2.2 Airways

Airways may be added as legs in flight plans with any waypoint that is part of an airway, such as a VOR.

1. On the Active Flight Plan page, touch the desired VOR entry waypoint in the flight plan. The Waypoint Options list will then be displayed.



Figure 4-16 Active Flight Plan with VOR Entry Wpt

2. Touch the **Load Airway** key to select an airway for the selected entry waypoint.



Figure 4-17 Select Load Airway from the Waypoint Options

3. Touch the desired airway to select it.



*Touch To Insert Selected Airway*

**Figure 4-18 Select an Airway from the List**

4. Scroll through the list and touch the desired exit point from the airway.



*Touch To Select Exit Waypoint*

**Figure 4-19 Select an Exit Waypoint for the Airway**

Foreword

Getting Started

Audio & Xpdr Ctrl

Com/Nav

FPL

Direct-To

Proc

Charts

Wpt Info

Map

Traffic

Terrain

Weather

Nearest

Music

Utilities

System

Messages

Symbols

Appendix

Load

- Confirm the airway information and then touch **Load** to insert the selected airway into the flight plan. Use the **In** and **Out** keys, and drag the map with your finger to view the airway detail. If changes are desired, touch the **Airway** or **Exit Waypoint** keys to select alternate choices.



Figure 4-20 Airway Information

- After loading the airway, it is inserted into the flight plan. The airway waypoints are shown below the **Airway** key on the display. Touch the airway to make any changes.

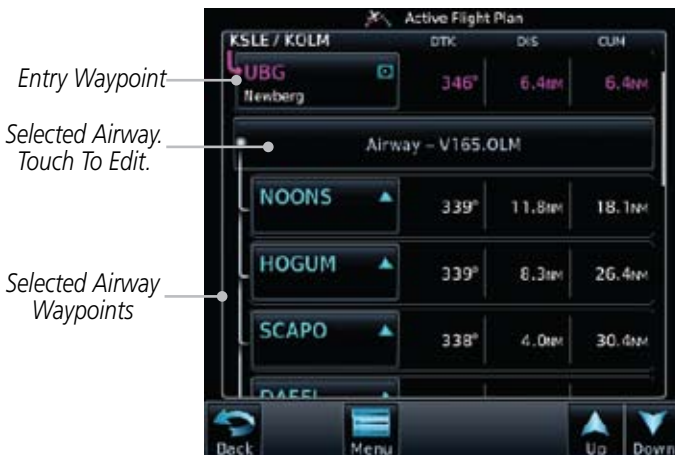

Figure 4-21 Airway Waypoints in the Flight Plan

7. Touch the **Airway** key to display the Airway Options. Make the desired choice or touch **Back**.



Figure 4-22 Airway Options



8. Touch the **Collapse All Airways** key to collapse the list of points along the airway. Touch the **Collapse All Airways** key again to toggle the display of airway detail back on.



Figure 4-23 Airways Collapsed In Flight Plan

### 4.3 Flight Plan Menu

The Flight Plan Menu provides access to functions to manage your flight plans. The functions included are: View Catalog, Store Flight Plan, Delete Flight Plan, Preview Flight Plan, Parallel Track, Invert Flight Plan, and Edit Data Fields.



Touch the **Menu** key to access the Flight Plan Menu options: View Catalog, Store Flight Plan, Delete Flight Plan, Preview Flight Plan, Parallel Track, Invert Flight Plan, and Edit Data Fields.



Figure 4-24 Flight Plan Menu

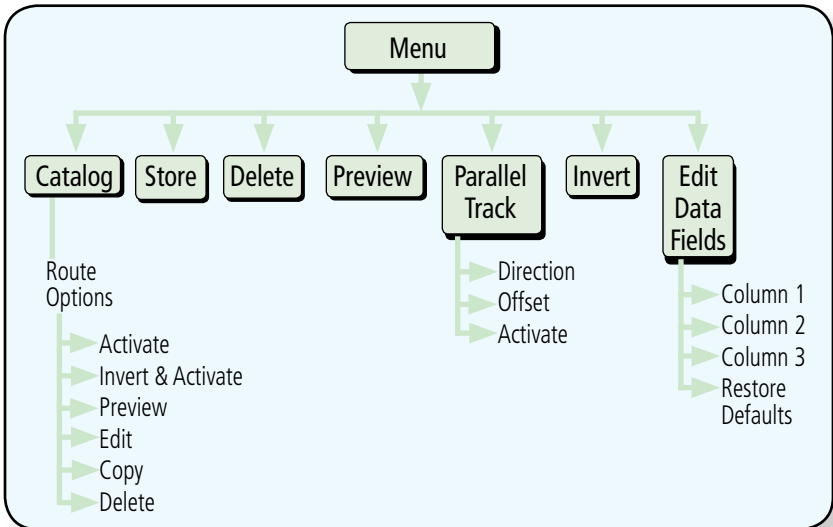
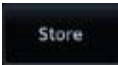

Figure 4-25 Flight Plan Menu Functional Diagram

## 4.3.1 Store Flight Plan

A newly created flight plan or one that has been modified must be saved to the Catalog to be used in future flights. The Store Flight Plan function will save the Active Flight Plan to the Catalog.



1. While viewing the Active Flight Plan page, touch the **Menu** key. The Flight Plan Menu will be displayed.
2. Touch the **Store** key to store the current Active Flight Plan into the Catalog. The flight plan will be named by the beginning and ending waypoints.
3. When a duplicate flight plan is created, the **Store** key will not be available and the flight plan will be saved with a numeral at the end of the destination waypoint.



Figure 4-26 Duplicate Flight Plan Naming

## 4.3.2 Invert Flight Plan

The Invert Flight Plan option allows you to reverse the Active flight plan and use it for navigation guidance back to your original departure point. The original flight plan stored in the catalog is not affected.



1. While viewing the Active Flight Plan page, touch the **Menu** key. The Flight Plan Menu will be displayed.
2. Touch the **Invert** key to invert the current Active Flight Plan.

### 4.3.3 Parallel Track

Parallel Track allows you to create a parallel course offset of 1 to 99 NM to the left or right of your current flight plan. After setting a parallel track to your current flight plan, a magenta parallel track line will be drawn offset from the original by the selected distance. The original course line will be drawn in grey. The aircraft will navigate to the parallel track course line and external CDI/HSI guidance will be driven from the parallel track.

When you reach the end of the flight plan, a message will state, “Parallel offset terminating in X seconds.” The message will be given when the aircraft reaches the offset distance from the end of the parallel track. This will give the pilot sufficient time to intercept the original course.

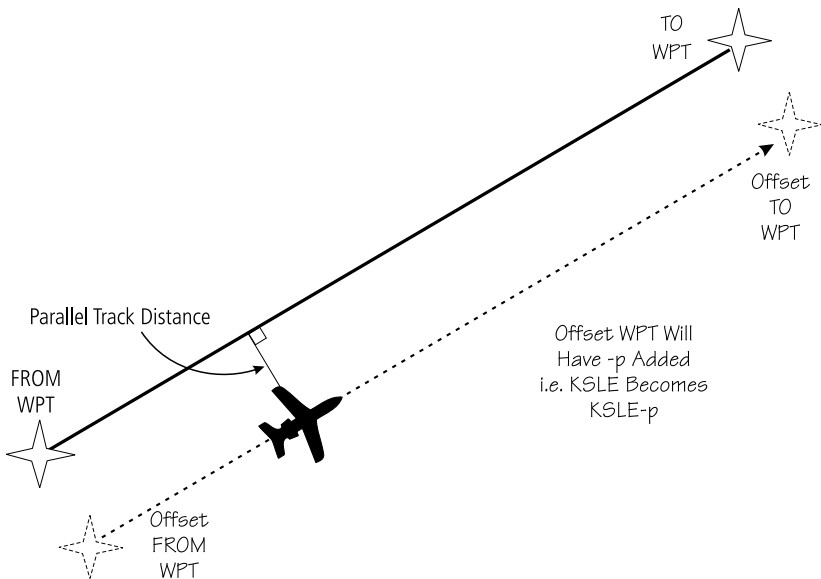

**Figure 4-27 Parallel Track Description**



**NOTE:** Parallel track will be cancelled when graphically editing a flight plan.

- Foreword
- Getting Started
- Audio & Xpdr Ctrl
- Com/Nav
- FPL**
- Direct-To
- Proc
- Charts
- Wpt Info
- Map
- Traffic
- Terrain
- Weather
- Nearest
- Music
- Utilities
- System
- Messages
- Symbols
- Appendix
- Index





**NOTE:** Certain leg types (such as approach) or leg geometries (changes in desired track greater than 120 degrees), combined with large offset values do not support parallel track. Default direction and offset values may result in the status indicating that parallel track is not supported. The user must enter the desired parallel track offset and distance to determine whether that flight plan, combined with the offset and distance, support parallel track.



1. While viewing the Flight Plan page, touch the **Menu** key, and then the **Parallel Track** key.



**Figure 4-28 Parallel Track Selection**



2. Touch the **Direction** key to toggle the Parallel Track to be Left or Right of the current Flight Plan.



3. Touch the **Offset** key to select the Parallel Offset from the current Flight Plan. Select the desired distance on the numeric keypad. Touch **Enter** when finished.



4. Touch the **Activate** key. A magenta "-P" indication will appear to the right of the waypoint name on the Active Flight Plan page.

Foreword  
Getting Started  
Audio & Xpdr Ctrl  
Com/Nav  
FPL  
Direct-To  
Proc  
Charts  
Wpt Info  
Map  
Traffic  
Terrain  
Weather  
Nearest  
Music  
Utilities  
System  
Messages  
Symbols  
Appendix



**Figure 4-29 Parallel Track Shown in the Active Flight Plan Page**

- To deactivate Parallel Track, while viewing the Active Flight Plan touch the **Menu** key. With the Flight Plan Menu displayed, touch the **Parallel Track** key.



**Figure 4-30 Deactivating Parallel Track**

- Touch the **Deactivate** key to cancel Parallel Tracking.



## 4.3.4 Edit Data Fields

The Active Flight Plan Page shows each waypoint for the flight plan, along with the Desired Track (DTK), Distance (DIS) for each leg and Cumulative Distance (CUM). The data fields are user-selectable and may be changed to display Cumulative Distance (CUM), Distance (DIS), Desired Track (DTK), En Route Safe Altitude (ESA), Estimated Time of Arrival (ETA), or Estimated Time En route (ETE).



Figure 4-31 Flight Plan Data Fields



1. While viewing the Flight Plan page, touch the **Menu** key, and then the **Edit Data Fields** key.

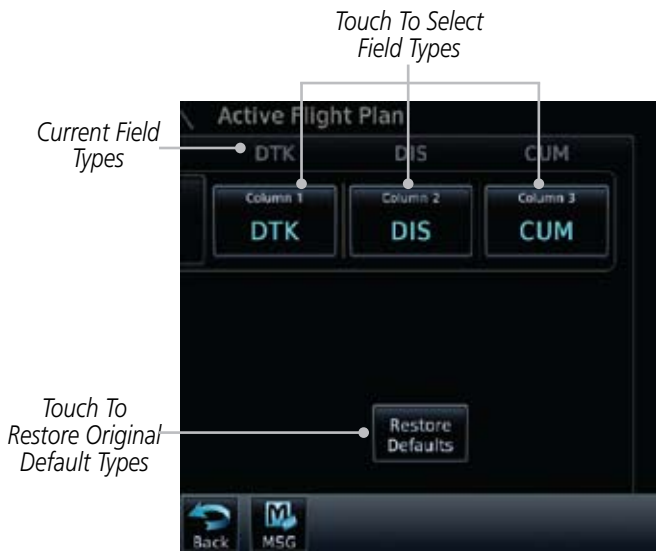
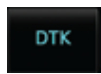

Figure 4-32 Flight Plan Edit Data Fields Page



2. Touch one of the field keys to select from the list.

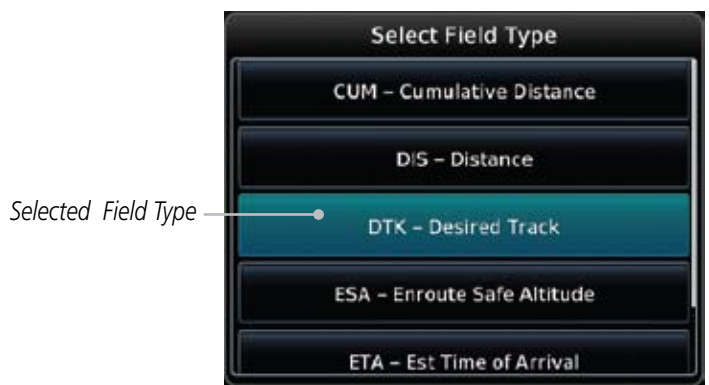

Figure 4-33 Flight Plan Data Fields List



3. Touch the **Up** or **Down** keys as needed, or touch and drag the list, to scroll through the list. Touch the desired Field Type to set it for the selected field.
4. Continue as desired for the other fields.

## 4.3.5 Flight Plan Catalog Route Options

The Flight Plan Catalog allows you to create, edit, activate, delete and copy flight plans. The catalog can hold up to 99 flight plans of up to 100 waypoints each. Flight plans are named by the Departure and Destination waypoint. Any time you activate a flight plan, a copy of the flight plan is automatically transferred to Active Flight Plan page and overwrites any previously active flight plan.



1. While viewing the Flight Plan page, touch the **Menu** key, and then the **Catalog** key. The list of currently stored flight plans will be displayed.

Flight Plan Name

Flight Plan Comment

Touch To Create New Catalog Route (Flight Plan)



Flight Plan Catalog Total

Touch Up/Down Keys To Scroll List

Figure 4-34 Flight Plan Catalog



2. Touch a flight plan to display the Route Options.

Selected Flight Plan

Flight Plan Route Options



Figure 4-35 Flight Plan Catalog Route Options

3. Touch the Route Option key for the desired option to act on the selected flight plan.

### 4.3.5.1 Catalog Route Option - Activate

1. While viewing the Flight Plan Catalog page, touch the desired flight plan to select it. The Route Options menu will be displayed.
2. Touch the **Activate** key and then touch **OK**. The selected flight plan will be activated.

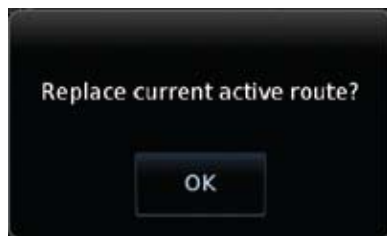

Figure 4-36 Touch OK to Replace the Existing Active Flight Plan

3. The Active Flight Plan page will now be displayed.

### 4.3.5.2 Catalog Route Option - Invert & Activate

1. While viewing the Flight Plan Catalog page, touch the desired flight plan to select it. The Route Options menu will be displayed.
2. Touch the **Invert & Activate** key and then touch **OK**. The selected flight plan will be inverted and activated.

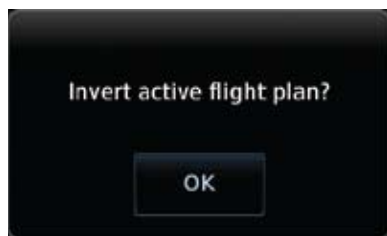

Figure 4-37 Touch OK to Invert and Activate the Selected Flight Plan

## 4.3.5.3 Catalog Route Option - Preview

1. While viewing the Flight Plan Catalog page, touch the desired flight plan to select it. The Route Options menu will be displayed.
2. Touch the **Preview** key. A map view of the flight plan and list of the waypoints will be displayed.
3. Touch the **Back** key to return to the Flight Plan Catalog.



## 4.3.5.4 Catalog Route Option - Edit

1. While viewing the Flight Plan Catalog page, touch the desired flight plan to select it. The Route Options menu will be displayed.
2. Touch the **Edit** key. The flight plan will be displayed. Make any changes necessary by touching the desired waypoint and using the Waypoint Options.



Selected Waypoint

Waypoint Options List

Figure 4-38 Use Waypoint Options to Edit the Selected Flight Plan

3. Touch the **Back** key to return to the Flight Plan Catalog.



## 4.3.5.5 Catalog Route Option - Copy

1. While viewing the Flight Plan Catalog page, touch the desired flight plan to select it. The Route Options menu will be displayed.
2. Touch the **Copy** key. You will be prompted to copy the selected flight plan.

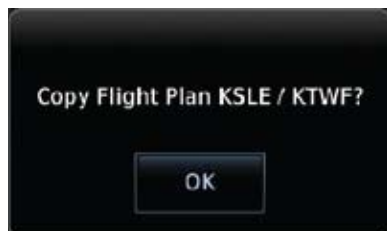
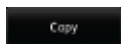

Figure 4-39 Flight Plan Catalog Route Copy Option

3. A copy of the selected flight plan will now be listed. If any changes are required for the copy, it can be used as a starting point for a similar flight plan. Use the Edit Route option to make the desired changes.

*Duplicate Copy Of Selected Flight Plan*



Figure 4-40 Copied Flight Plan

4. Touch the **Back** key to return to the Active Flight Plan.





## 4.3.5.6 Catalog Route Option - Delete

1. While viewing the Flight Plan Catalog page, touch the desired flight plan to select it. The Route Options menu will be displayed.
2. Touch the **Delete** key and then touch **OK**.

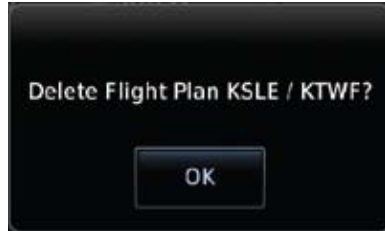

Figure 4-41 Delete the Selected Flight Plan from the Catalog



3. Touch the **Back** key to return to the Active Flight Plan.

### 4.3.6 Delete Flight Plan

There are two methods for deleting a flight plan. Deleting the selected flight plan from the Catalog using the Route Options completely removes the flight plan. Deleting the Active Flight Plan using the Delete Flight Plan key on the Flight Plan menu clears the waypoints from the Active Flight Plan, but does not remove the flight plan from the Catalog.

#### 4.3.6.1 Delete Flight Plan from Catalog

1. While viewing the Flight Plan page, touch the **Menu** key, and then the **View Catalog** key. The list of currently stored flight plans will be displayed.



Figure 4-42 Select a Flight Plan from the Catalog

2. Touch the **Delete** and then the **OK** key. The selected flight plan will be removed from the Catalog.

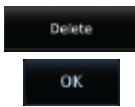

Figure 4-43 Delete a Flight Plan from the Catalog

## 4.3.6.2 Delete Active Flight Plan



1. While viewing the Active Flight Plan page, touch the **Menu** key, and then the **Delete Flight Plan** key.



Figure 4-44 Delete a Flight Plan from the Active Flight Plan



2. Touch **OK** to clear the waypoints from the Active Flight Plan. The flight plan will not be removed from the Catalog.

### 4.3.8 Preview Flight Plan

The Preview Flight Plan function provides a summary of a flight plan. A preview of the Active Flight Plan can be selected from the Flight Plan Menu's **Preview Flight Plan** key or selecting a flight plan from the catalog and choosing Preview from the Route Options menu.

#### 4.3.8.1 Previewing the Active Flight Plan

1. While viewing the Flight Plan page, touch the **Menu** key, and then the **Preview** key. A preview of the Active Flight Plan will be shown.

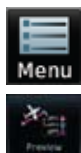

Flight Plan  
Waypoint List

Current Dest  
Waypoint

Map View  
of Flight  
Plan Legs

Current Ownship  
Position On  
Current Leg of  
Active Flight Plan

Figure 4-45 Active Flight Plan Preview

2. Touch the **Back** key to return to the Active Flight Plan page.



#### 4.3.8.2 Previewing a Flight Plan in the Catalog

1. While viewing the Flight Plan page, touch the **Menu** key, and then the **Catalog** key. The list of currently stored flight plans will be displayed.
2. Touch the desired flight plan. The Route Options will now be displayed.
3. Touch the **Preview** key to display a preview of the selected flight plan.
4. Touch the **Back** key to return to the Flight Plan Catalog.

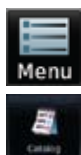

## 5 DIRECT-TO

The NRST pages can be used in conjunction with the GTN 7XX Direct-To function to quickly set a course to a nearby facility.

### 5.1 Direct-To Navigation



1. Press the **Direct-To** key on the right side of the unit. A flight plan must be activated or a Nearest Airport selected before information is provided in the Direct-To Wpt page.



Figure 5-1 Direct-To Wpt Page



2. Select **Waypoint**, **FPL**, or **NRST APT** from the Direct-To window by touching the desired tab.



3. If a specific course is desired, touch the **Course To** key.

Foreword  
Getting Started  
Audio & Xpdr Ctrl  
Com/Nav  
FPL  
**Direct-To**  
Proc  
Charts  
Wpt Info  
Map  
Traffic  
Terrain  
Weather  
Nearest  
Music  
Utilities  
System  
Messages  
Symbols  
Appendix



- Use the numeric keypad to select the course and then touch the **Enter** key.



**Figure 5-2 Direct-To Course Selection**

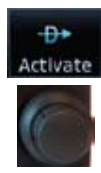

- Touch the desired waypoint and touch the **Activate** key or press the **small right** knob.

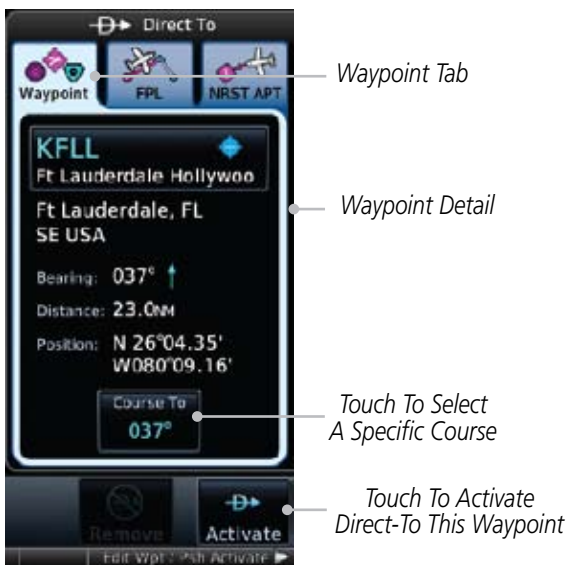

**Figure 5-3 Direct-To Selection**

- The Map page will now be displayed with the new Direct-To course.

## 5.2 Direct-To a Flight Plan Waypoint



1. Press the **Direct-To** key on the right side of the unit.
2. Touch the **FPL** tab at the top of the Direct-To window.



Figure 5-4 Direct-To Flight Plan Leg Selection

3. Touch the flight plan waypoint you want to navigate directly to. The Direct-To Waypoint page will display information about the selected flight plan waypoint.



Figure 5-5 Selected Direct-To Flight Plan Leg

Foreword  
 Getting Started  
 Audio & Xpdr Ctrl  
 Com/Nav  
 FPL  
**Direct-To**  
 Proc  
 Charts  
 Wpt Info  
 Map  
 Traffic  
 Terrain  
 Weather  
 Nearest  
 Music  
 Utilities  
 System  
 Messages  
 Symbols  
 Appendix



4. Touch the **Activate** key or press the **small right** knob to activate the selection.



5. The Map page will now be displayed with the new Direct-To course.

## 5.3 Direct-To a Nearest Airport



1. Press the **Direct-To** key on the lower right side of the unit.



2. Touch the **NRST APT** tab at the top of the Direct-To window. The nearest 25 airports within 200 NM will be listed. The airport at the top of the list is the nearest airport. To review the other nearest airports, touch the **Up** and **Down** keys to scroll through the list.

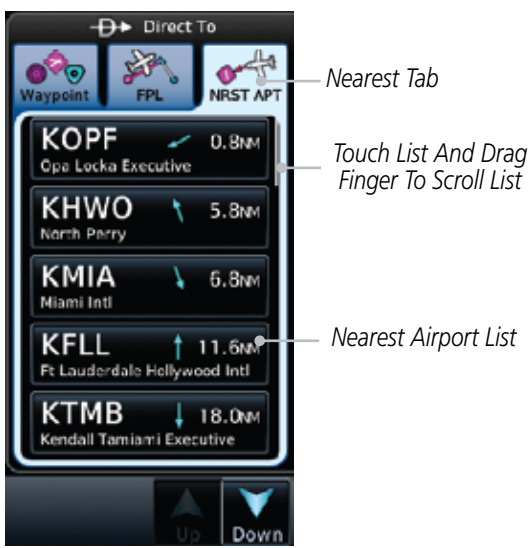

**Figure 5-6 Direct-To Nearest Airport Selection**



3. Touch the desired airport to select it. The selected airport will be displayed in the Waypoint page.



Figure 5-7 Selected Direct-To Nearest Airport

4. Touch the **Activate** key or press the **small right** knob to activate the selection.
5. The Map page will now be displayed with the new Direct-To course.

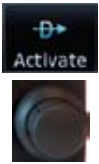

## 5.4 Removing a Direct-To Course

When a Direct-To course is cancelled, the previously active flight plan will be reactivated and the nearest leg to the aircraft position will become the active leg. If there was no active flight plan, after cancelling the Direct-To course the aircraft will continue with the current heading.



1. Press the **Direct-To** key to display the Direct-To page.



**Figure 5-8 Cancel the Direct-To Course**

2. Touch the **Remove** key.
3. Navigation will now return to the active flight plan.



## 5.5 Direct-To Map Waypoint

A Direct-To course may be set to any waypoint selected on the Map page. The waypoint is selected by touching an item such as an airport, VOR, or NDB or any other location. Touching the map page at any place not having an existing location name will create a waypoint with the name “MAPWPT.” Touching the **Direct-To** key will automatically insert the selected waypoint as the Direct-To waypoint. The MAPWPT will be saved as a User Waypoint.

1. On the Map page, touch the map at the location intended to be the Direct-To waypoint.
2. Press the **Direct-To** key on the right side of the unit.



**Figure 5-9 Touch the Map to Create a MAPWPT as the Direct-To Course Destination**



3. Touch the **Activate** key or press the **small right** knob to activate the selection.

## 5.6 Off-Route Direct-To Course

An off-route Direct-To course may be selected by using the Waypoint tab, Nrst Apt tab, or selecting an airport on the map. When an off-route Direct-To course is activated, the existing active flight plan will be deactivated. The original active flight plan and waypoint sequencing is reactivated when the Direct-To course is removed.



Figure 5-10 Active Flight Data is Removed When a Direct-To Course is Activated

## 6 PROCEDURES



The GTN 7XX allows you to fly non-precision and precision approaches to airports with published instrument approach procedures. All available approaches are stored on your Jeppesen NavData® card, and are automatically updated when the card's files have been updated. Approach procedures are not the same as the approach plates available in ChartView, which is a separate database. Subscription information for NavData cards is included in your GTN 7XX package.

The Procedures Page is displayed by touching the **PROC** key on the Home page. The Procedures Page provides direct access to approaches, departures and arrivals. Selections are also shown to: Activate Approach, Vectors to Final, and Activate Missed Approach.



**NOTE:** *The Chart feature provides a digital representation of a paper chart and provides no vertical or lateral course guidance. Flight Plan and Procedures are separate from Charts, and do provide vertical and lateral course guidance for the loaded route or procedure shown on the Flight Plan page. The term "Chart Unavailable" means that the chart cannot be viewed on the Charts due to either a chart not being published, or an error in the Chart database, but does not preclude its availability or inclusion of the procedure in the Flight Plan or Procedures portion of the system. The absence of a chart for a particular Departure, Arrival, or Approach does not preclude its availability or inclusion in the Flight Plan or Procedures portion of the system. The absence of a particular Departure, Arrival, or Approach under the Flight Plan or Procedures portion of the system does not preclude the ability to view the Chart for that procedure under the Chart feature.*

Foreword

Getting Started

Audio & Xpdr Ctrl

Com/Nav

FPL

Direct-To

Proc

Charts

Wpt Info

Map

Traffic

Terrain

Weather

Nearest

Music

Utilities

System

Messages

Symbols

Appendix

## 6.1 Basic Approach Operations

The GTN 7XX provides precision vertical guidance as well as lateral and advisory vertical guidance using its built in GPS receiver for GPS or RNAV approaches. The moving map pages can also be used as a supplemental aid to situational awareness for ILS, VOR, and NDB approaches (and non-precision localizer-based approaches), but the appropriate radio navigational aid **MUST** be used for primary approach course guidance for non-GPS approaches.

Approaches designed specifically for GPS are often very simple and don't require overflying a VOR or NDB. Currently, many non-precision approaches have "GPS overlays" to let you fly an existing procedure (VOR, VOR/DME, NDB, etc.) more accurately using GPS.

Many overlay approaches are more complex (in comparison to GPS-only approaches). The GTN 7XX displays and guides you through each leg of the approach — automatically sequencing through each of these legs, up to the missed approach point (MAP). Approaches may be flown "as published" with the full transition — using any published feeder route or initial approach fix (IAF) — or may be flown with a vectors-to-final transition.

Phase of flight annunciations are provided on the bottom of the display indicating the current mode of flight.

Procedures are arranged around the existing flight plan in the following order: Departure, En Route, Arrival, and Approach. For example, Departure waypoints are inserted before the En Route waypoints in the flight plan and Arrival waypoints are inserted between the En Route waypoints and the approach waypoints. Always verify that the transition waypoints between each phase are correct.

- Foreword
- Getting Started
- Audio & Xpdr Ctrl
- Com/Nav
- FPL
- Direct-To
- Proc**
- Charts
- Wpt Info
- Map
- Traffic
- Terrain
- Weather
- Nearest
- Music
- Utilities
- System
- Messages
- Symbols
- Appendix

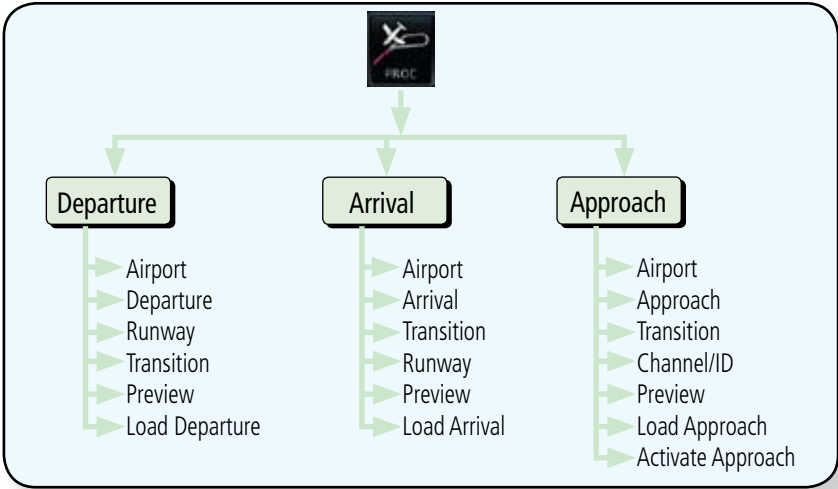

**Figure 6-1 Procedures Functional Diagram**

Annunciation	Description
LPV	Localizer Performance with Vertical guidance (LPV) approach. Fly to LPV minimums.
LP	Localizer Performance with no vertical guidance. Fly to LP minimums.
L/VNAV	Lateral Navigation and Vertical Navigation (LNAV/VNAV) approach. Fly to LNAV/VNAV minimums.
LNAV+V	GPS approach using published LNAV minima. Advisory vertical guidance is provided. Fly to LNAV minimums.
LNAV	Lateral Navigation approach. Fly to LNAV minimums.
MAPR	Missed Approach indicates the system is providing missed approach integrity and CDI full-scale deflection $\pm 0.3$ NM.
ENR	En route, CDI full-scale deflection is 2.0 NM or current CDI scale selection, whichever is smaller.
TERM	Terminal, CDI full-scale deflection is 1.0 NM or current CDI scale selection, whichever is smaller.
DPRT	Departure, indicates the system is using non-precision approach integrity. CDI full-scale deflection is 0.3 NM.
OCN	Oceanic, CDI full-scale deflection is 2.0 NM.
LOW ALT (lower window)	For LNAV+V, LNAV/VNAV, or LPV approaches, the LOW ALT annunciation indicates the aircraft's estimated height is lower than the Final Approach Waypoint height by approximately 50 meters. This annunciation will not be active when TAWS is operational.

**Table 6-1 Phase of Flight Annunciations**

## 6.2 Selecting a Departure

A Departure Procedure (DP) is loaded at the departure airport in the flight plan. Only one departure can be loaded at a time in a flight plan. If a departure is loaded when another departure is already in the active flight plan, the new departure replaces the previous departure. The route is defined by selection of a departure, the transition waypoint, and a runway.



**NOTE:** *Vector-only departures are not available in the Procedures database as the GTN 7XX cannot provide navigational guidance on vectored legs.*

1. Touch the **PROC** key on the Home page and then touch the **Departure** key to display the Departure list.
2. If necessary, touch the **Airport** key and enter the departure airport. Touch the key for the desired Departure.

*Touch To Select  
Desired Departure*



**Figure 6-2** List for Selecting a Departure



3. Touch the key for the desired Transition.

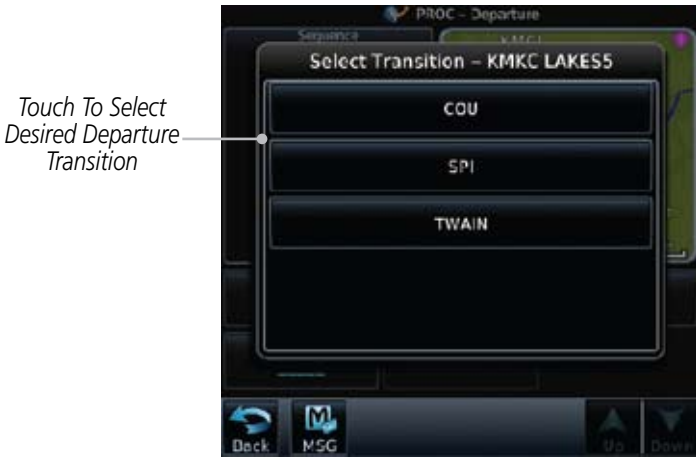

**Figure 6-3** Selecting a Transition for a Departure

4. Touch the key for the desired Runway, if necessary. The Departure page with preview will be displayed.



**Figure 6-4** Departure Selected



**NOTE:** If the selected runway is depicted as RW10B, for instance, this means both runways 10L and 10R.

Foreword  
Getting Started  
Audio & Xpdr Ctrl  
Com/Nav  
FPL  
Direct-To  
Proc  
Charts  
Wpt Info  
Map  
Traffic  
Terrain  
Weather  
Nearest  
Music  
Utilities  
System  
Messages  
Symbols  
Appendix

Load Departure

5. Touch the **Load Departure** key. The Active Flight Plan page will be displayed.

Touch To Change Or Remove Departure

Touch To Edit Waypoint



Scroll To View Flight Plan With Departure Waypoints

**Figure 6-5 Flight Plan After Loading a Departure**

6. Remove a departure or select a new one by touching the Departure key and selecting the desired choice.



Touch To Change A Departure

Touch To Remove Departure

**Figure 6-6 Editing a Departure**

## 6.3 Selecting an Arrival

A Standard Terminal Arrival (STAR) can be loaded at any airport that has one published. Only one arrival can be loaded at a time in a flight plan. If an arrival is loaded when another arrival is already in the active flight plan, the new arrival replaces the previous arrival. The route is defined by selection of an arrival, the transition waypoint, and a runway.



1. Touch the **PROC** key on the Home page and then touch the **Arrival** key.



Figure 6-7 Arrival Page

2. Confirm that the intended airport is shown or touch the **Airport** key and select the desired airport. Touch the key for the desired Arrival.



Figure 6-8 Arrival List

3. Touch the **Transition** key and then touch the key for the desired transition.

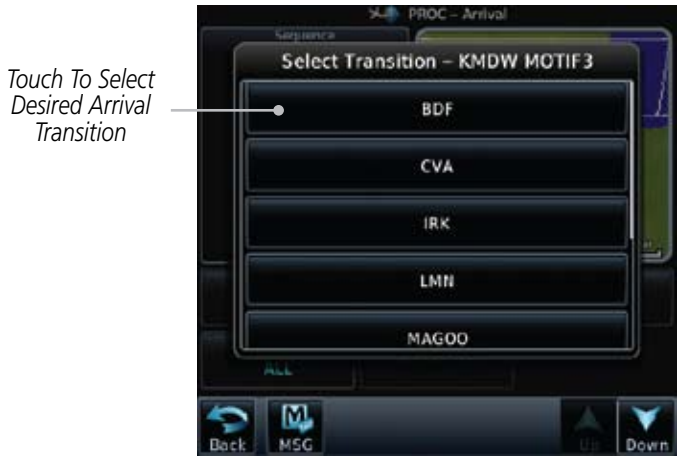

**Figure 6-9 Select Transition**

4. Touch the key for the desired Runway, if necessary.

**NOTE:** If the selected runway is depicted as RW10B, for instance, this means both runways 10L and 10R.

5. After selecting the runway, the Arrival page with map preview will be displayed.



**Figure 6-10 Previewing an Arrival**

Load Arrival

6. Touch the **Load Arrival** key. The Active Flight Plan page will be displayed.

Touch To Select Or Remove Arrival

Touch To Edit Waypoint



Figure 6-11 Flight Plan With Arrival Loaded

Foreword

Getting Started

Audio & Xpdr Ctrl

Com/Nav

FPL

Direct-To

Proc

Charts

Wpt Info

Map

Traffic

Terrain

Weather

Nearest

Music

Utilities

System

Messages

Symbols

Appendix

## 6.4 Selecting an Approach

Only one approach can be loaded at a time in a flight plan. If an approach is loaded when another approach is already in the active flight plan, the new approach replaces the previous approach. The route is defined by selection of an approach, the transition waypoint, and a runway.



1. Touch the **PROC** key on the Home page. The Approach, Arrival, and Departure fields will be dashed until a selection is made.

*Touch To View Available Departures*

*Touch To View Available Arrivals*

*Touch To View Available Approaches*



Figure 6-12 Procedures Selection Window

2. Touch the **Approach** key on the Procedures page to select an approach for the destination airport. Confirm that the intended airport is shown or touch the **Airport** key and select the desired airport.



- Foreword
- Getting Started
- Audio & Xpdr Ctrl
- Com/Nav
- FPL
- Direct-To
- Proc
- Charts
- Wpt Info
- Map
- Traffic
- Terrain
- Weather
- Nearest
- Music
- Utilities
- System
- Messages
- Symbols
- Appendix

3. Touch the **Approach** key on the Procedures-Approach page and then touch the key for the desired approach.



**Figure 6-13 Selecting an Approach**

4. After selecting the approach for the destination airport, the approach options will be displayed.

*Sequence List For The Selected Transition*

*Final Approach Fix* → VUPCU ▲ 255° 30.0 nm

*Missed Approach Point* → RW25 ▲ 255° 5.8 nm

*Missed Approach Hold Point* → SECAR ▲ 301° 13.3 nm

Hold 115° 0.0 nm

*Current Dest Waypoint. Touch To Select Airport.* → Airport: KTWF

*Touch To Select Channel/ID* → Channel / ID: 56311 W25A

*Touch To Select Approach* → Approach: RNAV 25 Gps LPV

*Touch To Load Approach* → Load Approach

*Touch To Select Transition* → Transition: Vectors

*Touch To Activate Approach* → Activate Approach

*Approach Diagram* → [Map showing approach path]

**Figure 6-14 Selected Approach Options**



5. Touch the **Transition** key and then touch the key for the desired transition.

Touch To Select Transition



**Figure 6-15 Select Approach Transition**



6. If desired, touch the Channel/ID key, then use the numeric keypad to select the channel number, and then touch the Enter key. The Channel and ID are typically loaded automatically if they are present.



**NOTE:** As an alternate means of loading an approach, the Channel ID key allows you to select the channel ID for a SBAS approach for the current destination. The channel ID for the SBAS approach is available from an approved approach chart. If duplicate numbers are available for a channel, a list will be available where you may select the desired approach.



7. Touch the **Load Approach** key. The Active Flight Plan page will be displayed. The approach waypoints are placed at the end of the flight plan and the unit will automatically sequence to them after the en route waypoints.

Destination Airport

Approach Waypoints



**Figure 6-16 After Loading an Approach**



Activate Approach

8. Touch the **Activate Approach** key, which makes the active leg Direct-To the IAF, or for Vector approaches to activate a leg that is an extended final approach course. You can also “activate” the selected procedure on the Procedures page, if the approach is not activated on this page.



Figure 6-17 After Activating the Approach

## 6.5 Approaches with Procedure Turns

The procedure turn portion of an approach is stored as one of the legs of the approach. For this reason, the GTN 7XX unit requires no special operations from the pilot — other than flying the procedure turn itself — beyond what is required for any other type of approach. Roll steering is provided to aircraft with compatible autopilots.

## 6.6 Flying the Missed Approach

If you are at the MAP and the runway environment isn't in sight, you must execute a missed approach. The GTN 7XX unit continues to give guidance along an extension of the final course segment (FAF to MAP) until you manually initiate the missed approach procedure (as mentioned previously in reference to the "SUSP" advisory).



**NOTE:** If the unit is not configured for a CDI key, then the "activate GPS missed approach" will only resume automatic waypoint sequencing. The user must switch to GPS navigation, if desired, by using their external source selection method (this is typical an EFIS system).

1. When the MAP is reached, a pop-up will appear.



Figure 6-18 Pop-Up Upon Reaching the MAP

2. Touch the **Remain Suspended** key to continue with sequencing suspended or touch **Activate GPS Missed Approach** for guidance to the Missed Approach Hold Point.



## 6.7 Flying an Approach with a Hold

Upon activating an RNAV GPS approach, you are given the option to skip any non-required holding patterns during the initial transitions of the approach. In a GPS approach, you will not be given the option and you must manually reselect waypoint sequencing.

The Flight Plan Page displays a timer or distance, as appropriate, during the holding pattern. Use this timer or distance to fly the outbound portion of the holding pattern. (The holding pattern is displayed on the Map Page and indicated as the active leg on the Active Flight Plan pages.)



**NOTE:** If you need to lose extra altitude or speed by going around the holding pattern again, touch **SUSP** to manually suspend waypoint sequencing BEFORE crossing the holding waypoint the second time. If you've already passed this waypoint, re-activate the holding pattern.

As you cross the MAP, a “SUSP” annunciation will appear, indicating that automatic sequencing of approach waypoints is suspended at the MAP. A “from” indication is displayed on the CDI and Default NAV Page, but course guidance along the final approach course continues.

## 6.8 Flying a DME Arc Approach

Approaches that contain DME arcs are supported by the GTN. The GTN will provide guidance (left / right) relative to the arc. If you wish to activate the DME arc leg manually, the aircraft must be near the arc, as shown in the shaded area below.

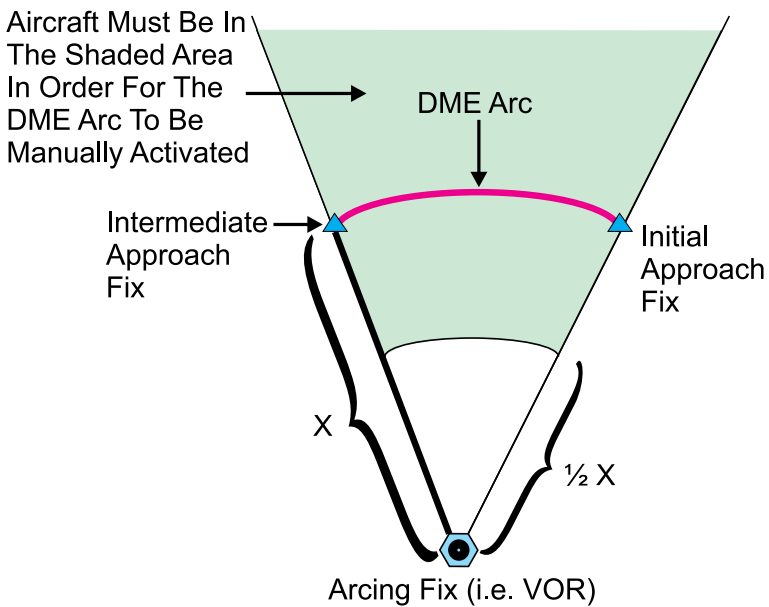

Figure 6-19 DME Arc Example

## 6.9 Vectors to Final

With “Vectors-To-Final” (VTF) selected, the CDI needle remains off center until you’re established on the final approach course. With the approach activated, the Map Page displays an extension of the final approach course in magenta (remember, magenta is used to depict the active leg of the flight plan) and “vtf” appears as part of the active leg on the Map page (as a reminder that the approach was activated with vectors-to-final).

## 6.10 ILS Approaches (GTN 750 Only)

Precision ILS approaches can be performed with the built-in VLOC (VOR/localizer/glide slope) receivers. The GPS receiver can be used for guidance prior to reaching the final approach fix, but once there, the proper frequency must be selected on the VLOC window (right side of screen) and the CDI output set to "VLOC".

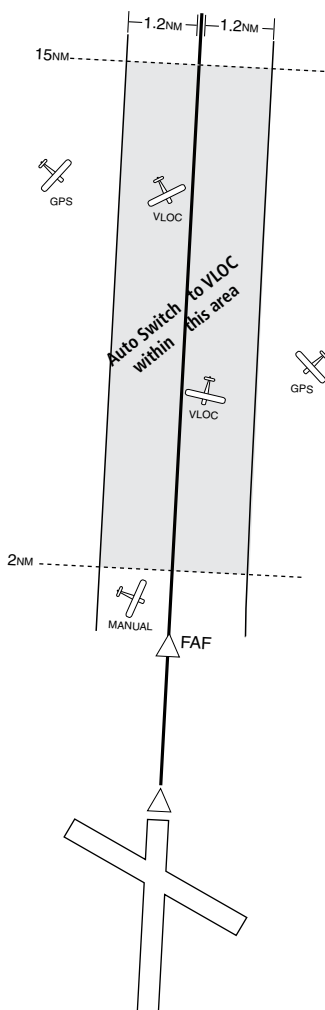

The GTN 7XX can be set to automatically switch the external CDI output from GPS to VLOC as you intercept the final approach course (if used with a KAP140/KFC225 autopilot, you will need to manually enable outputs). See instructions in the "Enabling Autopilot Outputs for the King KAP140/KFC225" section. When the ILS approach is activated (and the correct ILS frequency is active in the VLOC window), the GTN 7XX automatically switches within 1.2 NM left or right of the final approach course. This switch can take place anywhere from 2.0 to 15.0 NM from the FAF.

The illustration shows multiple locations along the approach path and the CDI selection that you can expect: GPS or VLOC. Within the area of the shaded box, the automatic switch from GPS to VLOC should occur.



**NOTE:** If you attempt to intercept the approach course at a distance less than 2.0 NM from the FAF, the GTN 7XX does not automatically switch the CDI to VLOC. In this case, touch the **CDI** key to manually switch from GPS to VLOC.

The automatic switch from GPS to VLOC is not immediate, but instead occurs gradually to prevent abrupt CDI changes when coupled to an autopilot. The CDI selection can also be changed manually by touching the **CDI** key.

## 6.11 RNAV Approach Procedures

The GTN 7XX allows for flying LNAV, LNAV/VNAV, LNAV + V, LP, and LPV approaches according to the published chart.

Phase of flight Annunciation	Description	Minimums
L/VNAV	Lateral Navigation/Vertical Navigation. RNAV non-precision approach with advisory vertical guidance.	Published LNAV/VNAV minimums.
LNAV	Lateral Navigation. RNAV non-precision approach.	Published LNAV minimums.
LNAV + V	Lateral Navigation with Advisory Vertical Guidance. RNAV non-precision LNAV approach with advisory vertical guidance. The glidepath is typically denoted by a light dashed line on the vertical profile (Jeppeson only) with an associated glidepath angle (usually in the 3.00 degree range) and is provided to assist the pilot in maintaining a constant vertical glidepath, similar to an ILS glideslope.	Published LNAV minimums.
LPV	Localizer Performance with Vertical guidance (LPV) approach. RNAV precision approach.	Published LPV minimums.
LP	LP indicates Localizer Performance with no vertical guidance.	Published LP minimums.

**Table 6-2 RNAV Approach Annunciations**

## 6.12 Points to Remember for All Procedures

- The GTN 7XX Map page is designed to complement your approach plates and vastly improve situational awareness throughout the approach. However, *you must always fly an approach as it appears on the approach plate.*
- The active leg (or the portion of the approach currently in use) is depicted in magenta on the Map Page. As you fly the approach, the GTN 7XX automatically sequences through each leg of the approach unless “SUSP” appears at the annunciation bar at the bottom of the display. “SUSP” indicates that automatic sequencing of approach waypoints is *suspended* on the current leg and normally appears at holding patterns, upon crossing the missed approach point (MAP), for Climb to Altitude legs, and for Hold to Altitude legs.
- For roll steering autopilots: roll steering is terminated when approach mode is selected on the autopilot and is available once the missed approach is initiated.
- If Vectors-to-Final is activated while on the “FROM” side of the FAF, automatic waypoint sequencing is suspended and the SUSP annunciation will appear. Automatic waypoint sequencing will resume once the aircraft is on the “TO” side of the FAF and within full-scale deflection.
- For all procedures, make sure to check the runway, transition, and all waypoints.

## 6.13 Points to Remember for Localizer or VOR-based Approaches

- The default factory setting allows the CDI output to automatically switch from the GPS receiver to the LOC receiver. This may be changed to manual in some installations. If the “ILS CDI Selection” setting is changed to “Manual”, *you must determine when to select “GPS” or “VLOC” guidance during the approach. Remember, “VLOC” is required for the final course segment from Final Approach Fix (FAF) to MAP.*



---

**NOTE:** *Installations with certain autopilots, such as the KAP 140 and KFC225, do not allow automatic ILS CDI switching.*

---



---

**NOTE:** *GPS phase of flight annunciations (LPV, ENR, etc.) are not applicable to the external CDI (or HSI) when VLOC is active.*

---

Foreword

Getting Started

Audio &amp; Xpdr Ctrl

Com/Nav

FPL

Direct-To

Proc

Charts

Wpt Info

Map

Traffic

Terrain

Weather

Nearest

Music

Utilities

System

Messages

Symbols

Appendix

Index

- If the CDI output has not automatically switched from GPS to ILS upon reaching the FAF, you must manually switch to the VLOC receiver by touching the **CDI** key. Verify that “VLOC” is displayed.
  - Automatic switching of CDI output is available for ILS, localizer, SDF and LDA approaches. Automatic CDI switching is *not* available for backcourse approaches or VOR approaches.
  - When flying an approach with the autopilot-coupled, you must monitor system functions at all times and verify that the autopilot and external CDI (or HSI) switch to the VLOC receiver with sufficient time to capture and track the approach course. Switching to “VLOC” late in the approach may not provide the autopilot enough time to respond and intercept the approach course prior to the FAF (depending upon the performance characteristics of your autopilot and aircraft). In such instances, you should manually fly the approach or refer to the documentation provided with your autopilot.
  - When an ILS or VOR approach is first selected or executed, the frequency is automatically checked. If the frequency is incorrect, you will receive a message and you must place the correct ILS or VLOC frequency in the active frequency field.
  - When flying a localizer-based approach (other than backcourse) with automatic CDI switching enabled:
    1. “GPS” guidance may be used while flying outbound and on the initial portion of the procedure turn.
    2. “VLOC” guidance is used on the remainder of the approach from the time you turn inbound on the procedure turn.
    3. The localizer frequency must be active to use “VLOC” guidance at the MAP.
- 
  - When flying a localizer-based approach with automatic CDI switching disabled.
    1. You may select “VLOC” guidance at any point on the approach prior to reaching the FAF.
    2. The localizer frequency must be active to use “VLOC” guidance.

## 6.14 Enabling Autopilot Outputs for the King KAP140/KFC225

Autopilot outputs for the King KAP140/KFC225 autopilots are activated manually by the pilot after being prompted during the approach procedure. After enabling outputs, the GTN 7XX will provide guidance information consistent with what the autopilot expects (i.e., angular CDI scaling and glideslope capture for an LPV or other vertically guided GPS approach).



**Figure 6-20 Prompt To Activate Autopilot Outputs**





**NOTE:** The availability of SafeTaxi, ChartView, or FliteCharts in electronic form may not preclude the requirement to carry paper charts aboard the aircraft. See the AFMS for more information.



**NOTE:** The Chart feature provides a digital representation of a paper chart and provides no vertical or lateral course guidance. Flight Plan and Procedures are separate from Charts, and do provide vertical and lateral course guidance for the loaded route or procedure shown on the Flight Plan page. The term “Chart Unavailable” means that the chart cannot be viewed on the Charts due to either a chart not being published, or an error in the Chart database, but does not preclude its availability or inclusion of the procedure in the Flight Plan or Procedures portion of the system. The absence of a chart for a particular Departure, Arrival, or Approach does not preclude its availability or inclusion in the Flight Plan or Procedures portion of the system. The absence of a particular Departure, Arrival, or Approach under the Flight Plan or Procedures portion of the system does not preclude the ability to view the Chart for that procedure under the Chart feature.

The chart page will default to the nearest airport if no flight plan or destination airport is present. While you are on the ground, the displayed charts will default to the current airport location regardless of flight plan. The optional ChartView and FliteCharts provide on-board electronic terminal procedures charts. Electronic charts offer the convenience of rapid access to essential information. Either ChartView or FliteCharts may be configured in the system, but not both.

ChartView resembles the paper version of Jeppesen terminal procedures charts. The charts are displayed in full color with high-resolution. The MFD depiction shows the aircraft position on the moving map in the plan view of approach charts and on airport diagrams. Airport Hot Spots are outlined in magenta. The ChartView database subscription is available from Jeppesen, Inc. Available data includes:

- Arrivals (STAR)
- Airport Diagrams
- Departure Procedures (DP)
- NOTAMs
- Approaches

An enablement card that is purchased from Garmin is separate from the Jeppesen database and is required to enable ChartView.



**NOTE:** The chart for the destination airport or loaded approach will automatically be selected.

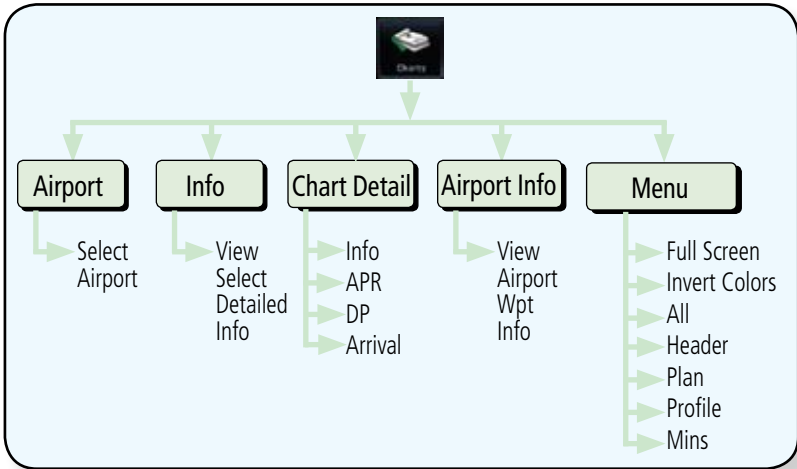

**Figure 7-1 Charts Functional Diagram**

The following list describes the order in priority in which charts are auto-loaded in the system when the Chart page is displayed:

1. The most-recently selected chart during the current power cycle, if valid\*,
2. The airport surface chart for the nearest airport, if on ground and nearest airport is found,
3. The approach chart for the approach in the active flight plan, if approach exists in the flight plan,
4. The airport surface chart for the last airport in the flight plan, if one exists,
5. The airport surface chart for the nearest airport, if nearest airport is found (same as #2 but aircraft could be in-air),
6. The airport surface chart for the first airport in the database, if found,
7. No chart.

\* “Selected” does not include charts that were auto-selected. A selection must be made while on the charts page.

There following actions will invalidate #1:

- Changing the approach in the active flight plan
- Changing the on-ground status while not viewing the Charts page

## 7.1 Chart Page



1. From the Home page, touch the **Charts** key.



Figure 7-2 Charts Function Page

2. Various controls allow viewing of more available detail.

### 7.1.1 Airport Selection



1. Touch the **Airport** selection key to select another airport.



2. Select the desired airport identifier with the keypad and touch **Enter**.



Figure 7-3 Airport Identifier Selection

## 7.1.2 Info

1. Touch the **Info** key to select the specific information chart.



*Touch To View Selected Airport Info*

**Figure 7-4 Airport Info Selection**

2. Touch an item from the list to view the chart.



*Selected Airport*

*Touch To View Selected Airport Info List*

*Detailed View Of Selected Airport Info*

**Figure 7-5 Airport Info Selection Detail**

## 7.1.3 Information

1. Touch the **Information** key.
2. View the available airport information charts.



## 7.1.4 Approaches



1. Touch the **Approaches** key to view available approaches.



Figure 7-6 Approach Detail



2. Touch the **Approach** key to select an approach chart.



Figure 7-7 Approach List

3. Touch the desired approach to view detailed information.

## 7.1.5 Departures

1. Touch the **Departures** key to view available departures.



**Figure 7-8** Departure Detail

2. Touch the **Departure** key to change the selected Departure chart.



**Figure 7-9** Departure List

3. Touch the desired departure to view detailed information.

## 7.1.6 Arrivals



1. Touch the **Arrivals** key to view available arrivals.



Figure 7-10 Arrival Detail

2. Touch the **Arrival** key to change the selected Arrival chart.

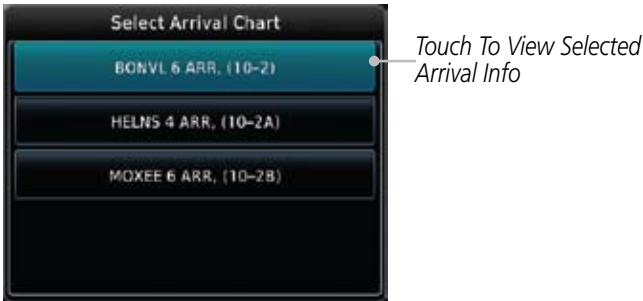

Figure 7-11 Arrival List

3. Touch the desired arrival to view detailed information.

## 7.1.7 Airport Info



1. Touch the Airport Info key to view the Waypoint Info for the selected airport.

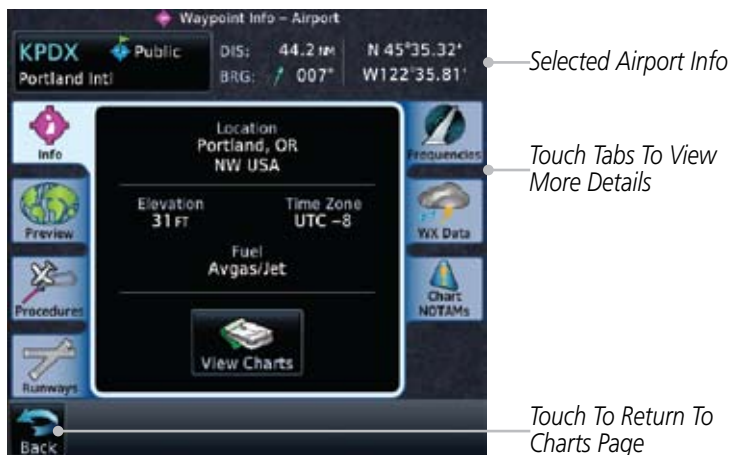

Figure 7-12 Selected Airport Detail



2. Touch the **Back** key to return to the Charts page.

Foreword  
Getting Started  
Audio & Xpdr Ctrl  
Com/Nav  
FPL  
Direct-To  
Proc  
Charts  
Wpt Info  
Map  
Traffic  
Terrain  
Weather  
Nearest  
Music  
Utilities  
System  
Messages  
Symbols  
Appendix



## 7.1.8 Full/Split Screen



1. Touch the **Full** key to display a full screen view of the current chart page.



Full Chart Page View

Touch To Return To Split Chart Page View

Figure 7-13 Full View of Chart Page



2. Touch the **Split** key to display a view of the current chart page split between the chart detail and chart page controls.



Split Chart Page View

Touch To Display Full Chart Page View

Figure 7-14 Split View of Chart Page

## 7.2 Chart Menu Options

1. From the Charts page, touch the **Menu** key.



*Touch To Select  
Chart Layer*

*Touch To Display  
Normal Or Inverted  
Chart Colors*

Figure 7-15 Chart Options

2. Touch the **Chart Information** key to select a Chart Layer. Chart Layers are only available with ChartView.

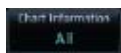

*Current Selected  
Chart Layer*

*Touch To Select  
Chart Layer*

Figure 7-16 Select From Chart Layer List

3. Touch the desired selection to display the selected Chart Layer.

Foreword  
Getting Started  
Audio & Xpdr Ctrl  
Com/Nav  
FPL  
Direct-To  
Proc  
Charts  
Wpt Info  
Map  
Traffic  
Terrain  
Weather  
Nearest  
Music  
Utilities  
System  
Messages  
Symbols  
Appendix

## 7.2.1 Chart Layers - All

Touch the **All** key to view the composite of layers available for the selected chart.

## 7.2.2 Chart Layers - Header

Touch the **Header** selection from the Chart Layer list to view the header information for the selected approach chart.

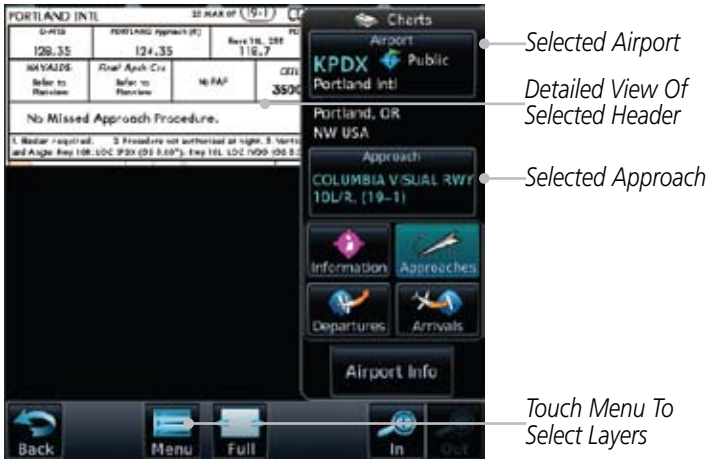

Figure 7-17 Header View of Chart for the Selected Approach

## 7.2.3 Chart Layers - Plan

Touch the **Plan** selection from the Chart Layer list to view the Plan View for the selected approach chart.



Figure 7-18 Plan View of Chart for the Selected Approach

## 7.2.4 Chart Layers - Profile

Touch the **Profile** selection from the Chart Layer list to view the vertical profile of the selected approach.



Figure 7-19 Profile View of Chart for the Selected Approach

## 7.2.5 Chart Layers - Minimums

Touch the **Minimums** selection from the Chart Layer list to view the minimums for the selected approach.



Figure 7-20 Minimums View of Chart for the Selected Approach

- Foreword
- Getting Started
- Audio & Xpdr Ctrl
- Com/Nav
- FPL
- Direct-To
- Proc
- Charts
- Wpt Info
- Map
- Traffic
- Terrain
- Weather
- Nearest
- Music
- Utilities
- System
- Messages
- Symbols
- Appendix
- Index

## 7.2.6 Invert Colors



While viewing the Charts Menu, touch the **Invert Colors** key to show an inverted color view of the display that enhances low light viewing.

*Inverted Color Chart Page View*



*Touch For Inverted Color Chart Page View*

Figure 7-21 Inverted Chart Colors View

## 7.3 ChartView Cycle Number and Revision

The ChartView database is revised every 14 days. Charts are still viewable during a period that extends from the cycle expiration date to the disables date. ChartView is disabled 70 days after the expiration date and is no longer available for viewing upon reaching the disable date. When turning on the GTN unit, the Power-up Page indicates the criteria for ChartView availability. An enablement card that is purchased from Garmin is separate from the Jeppesen database and is required to enable ChartView. Jeppesen does not provide the Effective date.

*ChartView Cycle*  
*ChartView Expiration Date*



*Info Not Provided*  
*ChartView Will Be Disabled On This Date*

Figure 7-22 System Status Database Information for ChartView

The database CYCLE number, EXPIRES, and DISABLES dates of the ChartView database appear in either white or yellow text. When the ChartView EXPIRES date is reached, ChartView becomes inoperative 70 days later. This is shown as the DISABLES date. When the DISABLES date is reached, charts are no longer available for viewing.

The ChartView database is provided directly from Jeppesen. Refer to Jeppesen Databases in Appendix A for instructions on revising the ChartView database.

## 7.4 FliteCharts®

FliteCharts® resemble the paper version of National Aeronautical Charting Office (NACO) terminal procedures charts. The charts are displayed with high-resolution and in color for applicable charts.

Garmin FliteCharts is an electronic version of the National Aeronautical Navigation Services Charts (AeroNav Services), which was formerly NACO. FliteCharts lets pilots quickly find and view all AeroNav Services Departure Procedures (DP), Standard Terminal Arrival Routes (STARs), approach charts, and airport diagrams. If the current approach is known, the GTN 7xx automatically selects the correct chart based on the flight plan. Pilots will have access to all approach plates currently published by AeroNav, which encompasses over 15,000 charts and over 2,900 airports in the U.S. FliteCharts updates are available from Garmin every 28 days, and the new georeferenced capability will be included with the regular updates.

FliteCharts database subscription is available from Garmin. Available data includes:

- Arrivals (STAR)
- Departure Procedures (DP)
- Approaches
- Airport Diagrams

## 7.4.1 FliteCharts Cycle Number and Revision

FliteCharts data is revised every 28 days. Charts are still viewable during a period that extends from the cycle expiration date to the disables date. FliteCharts is disabled 180 days after the expiration date and are no longer available for viewing upon reaching the disables date. When turning on the GTN 7XX, the Power-up page indicates the criteria for chart availability. These indications are whether the databases are not configured, not available, current, out of date, or disabled.



Figure 7-23 System Status Database Information for FliteCharts

## 7.5 SafeTaxi®

SafeTaxi® is an enhanced feature that gives greater map detail when zooming in on airports. The airport display on the map reveals runways with numbers, taxiways with identifying letters/numbers, airport Hot Spots, and airport landmarks including ramps, buildings, control towers, and other prominent features. Resolution is greater at lower map ranges (zooming in). When the aircraft location is within the screen boundary, including within SafeTaxi ranges, an airplane symbol is shown on any of the navigation map views for enhanced position awareness.

Designated Hot Spots are recognized at airports with many intersecting taxiways and runways, and/or complex ramp areas. Airport Hot Spots are outlined to caution pilots of areas on an airport surface where positional awareness confusion or runway incursions happen most often. Hot Spots are defined with a magenta circle or outline around the region of possible confusion.



Figure 7-24 SafeTaxi Depiction on the Navigation Map Page

### 7.5.1 Using SafeTaxi®

Any map page that displays the navigation view can also show the SafeTaxi® airport layout within the maximum configured range. Charts and SafeTaxi are mutually exclusive. So, to view SafeTaxi and Hot Spots, the Charts feature must be turned off. Charts are displayed when the aircraft is in the air, but when on the ground, charts are removed and SafeTaxi will be shown automatically.

During ground operations the aircraft's position is displayed in reference to taxiways, runways, and airport features. The nose of the ownship symbol, not the center, depicts the current location of the aircraft.



## 7.5.2 Hot Spot Information

Hot Spot locations are identified by a magenta circle or outline.



Figure 7-25 SafeTaxi Hot Spot Depiction

## 7.5.3 SafeTaxi® Cycle Number and Revision

The SafeTaxi database is revised every 56 days. SafeTaxi is always available for use after the expiration date. When turning on the GTN 7XX, the Power-up Page indicates whether the databases are current, out of date, or not available. The Power-up Page shows the SafeTaxi database is current when the “SafeTaxi Expires” date is shown in white. When the SafeTaxi cycle has expired, the “SafeTaxi Expires” date appears in yellow. The message “unknown” appears in white if no SafeTaxi data is available on the database card.

The SafeTaxi Region, Version, Cycle, Effective date and Expires date of the database cycle can also be found on the System - System Status page. SafeTaxi information appears in white and yellow text. The EFFECTIVE date appears in white when data is current and in yellow when the current date is before the effective date. The EXPIRES date appears in white when data is current and in yellow when expired. SafeTaxi REGION NOT AVAILABLE appears in white if SafeTaxi data is not available on the database card.

Foreword

Getting  
Started

Audio &  
Xpdr Ctrl

Com/Nav

FPL

Direct-To

Proc

Charts

Wpt Info

Map

*This page intentionally left blank*

Traffic

Terrain

Weather

Nearest

Music

Utilities

System

Messages

Symbols

Appendix

## 8 WAYPOINT INFO



The Waypoint Info function allows you to view information about the selected waypoint. The Waypoint Info page can be reached from the Home page, selected from a flight plan, or selected from the Nearest page.



*Touch Key to Display  
Waypoint Type*

**Figure 8-1** Waypoint Info Page



Figure 8-2 Waypoint Info Functional Diagram

## 8.1 Waypoint Selection



1. Touch the **Waypoint Info** key and then touch the desired waypoint type (Airport, INT, VOR, etc).
2. Touch the waypoint identifier.
3. The waypoint identifier selection page will be shown and the waypoint identifier field will be active for selection. Touch the required keys on the alphanumeric keypad to select the desired waypoint identifier and then touch the **Enter** key.

Airport Identifier  
Find Key Displays  
Waypoint Search



Backspace  
Key Clears  
Wpt Ident

Cursor  
Movement  
Keys

Alphanumeric  
Keypad

Touch Enter  
After Selecting  
Ident

Touch To Cancel  
Selection And  
Return To  
Previous Page

Figure 8-3 Waypoint Ident Selection

4. The information page for the selected waypoint will be displayed.



Figure 8-4 Waypoint Ident Selection Result

## 8.2 Airport



The Airport page of the Waypoint Info function provides a variety of detailed information about the airport.

### 8.2.1 Info

The upper part of the page shows the airport identifier and type, name, city and region, the lat/lon coordinates of the airport, and the bearing (and direction arrow) and distance to the airport from your present position. The center area shows the airport elevation, fuel availability, and time zone.

1. While viewing the Waypoint Info page, touch the **Airport** key.



*Distance & Bearing To Airport  
From Current Position*

*Airport Identifier, City, & Type*

*Waypoint Info Page Tab*

*Airport Information*

*Touch To View Airport Charts*

*Airport Lat/Lon*



Figure 8-5 Waypoint Info Airport Page

2. Touch the **View Charts** key to display available charts for the airport.



## 8.2.2 Preview

The Waypoint Info Airport Preview page provides detailed information about the selected airport.



1. Touch the **Preview** tab to view a map of the airport and surrounding area.
2. Use the **In** and **Out** keys to zoom in and out on the Preview map.



**Figure 8-6** Waypoint Info Airport Map Page

3. You may touch the map window and while pressing the display drag your finger to move the map view.

## 8.2.3 Procedures

1. Touch the **Procedures** page tab to view details about procedures for the selected airport.



Distance & Bearing To Airport  
From Current Position

Airport Identifier, City, & Airport Type



Airport Lat/Lon

Approach Name & Type

Procedures Page Tab

Touch To Scroll

Figure 8-7 Waypoint Info Airport Procedures Page

2. Touch the **Up** and **Down** keys to view additional procedures, as needed.
3. Touch one of the procedure keys to select it for the Procedures function.

Distance & Bearing To Airport  
From Current Position

Airport Identifier, City, & Airport Type



Airport Lat/Lon

Arrival Name

Procedures Page Tab

Touch To Scroll

Figure 8-8 Waypoint Info Airport Arrival Information



## 8.2.4 Runways



**Figure 8-9** Waypoint Info Airport Runway Information Page



1. Touch the **Runways** tab to view information about the available runways for the selected airport. The runway identifiers, surface type, lighting with Pilot Controlled Lighting (PCL) frequency, runway size, and Traffic Pattern direction are shown.
2. Touch the **PCL** key to load the PCL frequency into the Com Standby location.

## 8.2.5 Frequencies

1. Touch the **Frequencies** tab to view details about available frequencies for the selected airport.
2. Touch the **Up** and **Down** keys to view additional frequencies, as needed. A "c" symbol in a white circle will appear next to frequencies that also function as the Common Traffic Advisory Frequency (CTAF).



Figure 8-10 Waypoint Info Airport Frequency List Page

3. Touch the **Frequency** key next to the frequency name to load it as the Com or Nav standby frequency, depending on frequency type.

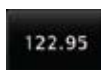

## 8.2.6 Weather (WX) Data



1. Touch the **WX Data** tab next to the center window to view textual METARs, City Forecast, and TAF weather information available for the selected airport.



Figure 8-11 Waypoint Info Airport Weather Page



2. Touch the **Up** and **Down** keys to scroll through the Weather page information.



Figure 8-12 Waypoint Info Airport Weather Forecast Page

## 8.2.7 NOTAM Pages

1. Touch the **Chart NOTAMs** tab next to the center window to view any Chart NOTAMs available for the selected airport. This feature is only supported with ChartView.



Figure 8-13 Waypoint Info Airport NOTAMs Page

2. Touch the **Up** and **Down** keys to view additional information, as needed.



## 8.3 Intersection (INT)

The Intersection page of the Waypoint Info function provides a variety of detailed information about the intersection. The top left area of the page displays the Intersection identifier and region. The top center area shows the lat/lon coordinates of the Intersection and the bearing (with direction arrow) and distance to the Intersection from your present position.

Select another Waypoint by touching the **Waypoint Identifier** key, entering the characters for the desired name with the alphanumeric keypad, and then touching the **Enter** key. You may also search through the list by touching the **Find** key and then choosing from the existing list of waypoints by touching the desired waypoint from the list.

The center area of the page shows a map with the Intersection in the center.



1. While viewing the Waypoint Info page, touch the **Intersection** key.

*Distance & Bearing To Intersection  
From Current Position*



**Figure 8-14** Waypoint Info - Intersections

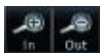

2. Use the **In** and **Out** keys to zoom in and out on the map. You may touch the map window and while lightly pressing the display, drag your finger to move the map view.

## 8.4 VOR

The VOR page of the Waypoint Info function provides a variety of detailed information about the VOR. The top left area of the page displays the VOR identifier, name, city and state, and region. The top center area shows the lat/lon coordinates of the VOR and the bearing (with direction arrow) and distance to the VOR from your present position. The top right area shows the frequency in a key. Select another Waypoint by touching the **Waypoint Identifier** key, entering the characters for the desired name with the alphanumeric keypad, and then touching the **Enter** key. You may also search through the list by touching the **Find** key and then choosing from the existing list of waypoints by touching the desired waypoint from the list.

The center area of the page shows a map with the VOR in the center.

1. While viewing the Waypoint Info page, touch the **VOR** key.



Figure 8-15 Waypoint Info - VORs

2. Use the **In** and **Out** keys to zoom in and out on the map. You may touch the map window and while lightly pressing the display, drag your finger to move the map view.
3. Touch the **Frequency** key next to load it as the Nav standby frequency.



## 8.5 NDB



The NDB page of the Waypoint Info function provides a variety of detailed information about the NDB. The top left area of the page displays the NDB identifier, name, city and state, and region. The top center area shows the lat/lon coordinates of the NDB and the bearing (with direction arrow) and distance to the NDB from your present position. The top right area shows the frequency in a key.

Select another Waypoint by touching the **Waypoint Identifier** key, entering the characters for the desired name with the alphanumeric keypad, and then touching the **Enter** key. You may also search through the list by touching the **Find** key and then choosing from the existing list of waypoints by touching the desired waypoint from the list.

The center area of the page shows a map with the NDB in the center.



1. While viewing the Waypoint Info page, touch the **NDB** key.



Figure 8-16 Waypoint Info for NDBs



2. Use the **In** and **Out** keys to zoom in and out on the map. You may touch the map window and while lightly pressing the display, drag your finger to move the map view.

## 8.6 User Waypoints (User)



In addition to the airport, VOR, NDB and intersection information contained in your Jeppesen NavData® card, the GTN 7XX allows you to store up to 1,000 user-defined waypoints. The User Waypoint Page displays the waypoint name (up to six characters long), identifier and radial from two reference waypoints, distance from one reference waypoint, along with the user waypoint's lat/lon position.

The following descriptions and abbreviations appear on the User Waypoint Page:

- Ref Wpt — Reference waypoint identifier (name)
- Radial — Radial from reference waypoint, in degrees magnetic or degrees true (depending upon unit configuration)
- Distance — Distance from reference waypoint, in nautical miles/statute miles/kilometers (depending upon unit configuration)
- Lat/Lon — Latitude/Longitude (degrees/minutes or degrees/minutes/seconds), MGRS or UTM/UPS



Figure 8-17 Waypoint Info for a User Waypoint

Select another Waypoint by touching the **Waypoint Identifier** key, entering the characters for the desired name with the alphanumeric keypad, and then touching the **Enter** key. You may also search through the list by touching the



**View All** key and then choosing from the existing list of User waypoints by touching the desired waypoint from the list.

## 8.6.1 Select User Waypoint By Name



1. While viewing the User Waypoint page, touch the User Waypoint Name.
2. Use the keypad to select the characters for the name and then touch **Enter**.



## 8.6.2 Select User Waypoint From A List



1. While viewing the Waypoint Info page, touch the **User Waypoint** key.
2. Touch the **View All** key and then use the **Up** and **Down** keys to view the waypoints on the list.



User Waypoint List Name

User Waypoint Type



User Waypoint List

Figure 8-18 Waypoint Info User Waypoint List

## 8.6.3 Edit User Waypoint



1. Select the desired User Waypoint and touch the **Edit** key.
2. Touch the key for the desired information and make changes as needed.

## 8.6.4 Delete User Waypoint

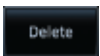

1. Select the desired User Waypoint and touch the **Delete** key.
2. Touch the **OK** key to confirm deleting the selected waypoint.

## 8.7 Create Waypoint



User waypoints are created from the Create User Waypoint page. To create a new user waypoint, simply enter its name (identifier) and position, or reference another waypoint by radial and distance.



**Figure 8-19** Waypoint Info - Create User Waypoint

1. From the Waypoint Info page, touch the **Create Waypoint** key.
2. Touch the **User Identifier** key.
3. Use the alphanumeric keypad to make the waypoint name (up to six characters) and then touch the **Enter** key.



**Figure 8-20** Waypoint Info - Create User Waypoint Name

Comment  
USG161 / C90009

4. Touch the **Comment** key to add a short comment for the new waypoint.

Position Type  
Radial / Radial

5. Touch the **Position Type** key and then **Lat/Lon**, **Radial/Radial**, or **Radial/Distance** to assign the type. See the following instructions for more detail.

*Touch to Select the  
Desired Waypoint  
Position Type*



**Figure 8-21** Waypoint Info - Create User Position Type

Temporary?  
[Progress Bar]

6. If desired, touch the **Temporary?** key to create the waypoint for only temporary use. Temporary waypoints will be removed when the power is cycled.

Create

7. When finished with all selections, touch the **Create** key to create the new waypoint.

## 8.7.1 Waypoint Location Based on Lat/Lon Coordinates

1. From the Create User Waypoint page, touch the **Position Type** key and then the **Lat/Lon** key. Then, touch the **Latitude/Longitude** value key.



Touch to Select Lat/Lon Waypoint Reference Type



Figure 8-22 Waypoint Info - Create User Waypoint Type - Lat/Lon

2. The Lat/Lon coordinate values will be highlighted. Touch the **Lat** or **Lon** key to toggle selection of the hemisphere values and highlight the selected value.

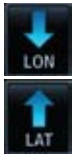

Touch To Toggle Lat/Lon

When The Lat Key Is Touched, The Latitude Hemisphere Value Is Active For Selection



Touch to Select Numeric Values

Touch to Select Hemisphere Value

Figure 8-23 Lat/Lon Coordinate Selection

3. Touch the desired hemisphere keys to select the desired values. After selecting the hemisphere value, the cursor will advance to the the first character of the adjacent numeric value for selection. Even when the hemisphere values are highlighted,



touching the numeric keys will always place the cursor at the first numeric value. The **Large** knob may also be used for cursor movement and characters are selected with the **Small** knob.



**NOTE:** When editing values, turn the Large knob counter-clockwise to backspace or move the cursor to the left.

4. As each value is selected, the cursor will advance to the next character. Touch the necessary key for the desired values.
5. When finished with the Lat/Lon selections, touch the **Enter** key.
6. When finished with all selections, touch the **Create** key to create the new waypoint.

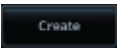

## 8.7.2

### Waypoint Location Based on Two Radials

1. From the Create User Waypoint page, touch the **Position Type** key and then the **Radial/Radial** key.



*Touch to Select Radial/Radial Waypoint Reference Type*



**Figure 8-24** Waypoint Info - Create User Waypoint Type - Radial/Radial

2. Touch the **Ref Wpt** key and use the alphanumeric keypad to select the desired identifier.
3. Touch the upper **Radial** key and use the alphanumeric keypad to select the desired value.
4. Touch the **Enter** key.
5. When finished with all selections, touch the **Create** key to create the new waypoint.

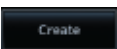

## 8.7.3 Waypoint Location Based on Radial and Distance

1. From the Create User Waypoint page, touch the **Position Type** key and then the **Radial/Distance** key.

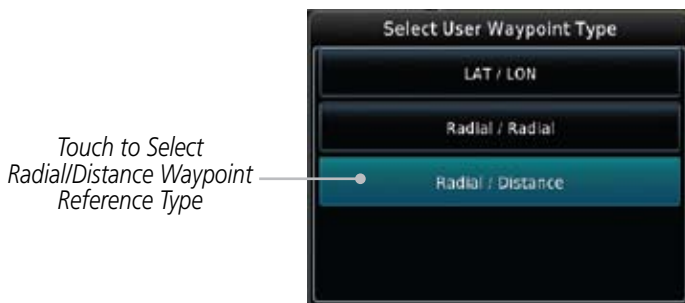

**Figure 8-25** Waypoint Info - Create User Waypoint Type - Radial/Distance

2. From the Create User Waypoint page, touch the **Ref Wpt** key and use the alphanumeric keypad to select the desired identifier.
3. Touch the upper **Radial** key and use the alphanumeric keypad to select the desired value.
4. Touch the upper **Distance** key and use the alphanumeric keypad to select the desired value.
5. Touch the **Enter** key.
6. Touch the **Create** key to save the new waypoint.

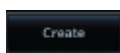

## 9 MAP

The Map page is used to provide situational awareness in flight. The Map page can display the following information:

- Airports, NAVAIDs, airspace, airports, land data (highways, cities, lakes, rivers, borders, etc.) with names
- Wind direction and speed
- Icons for enabled map features
- Aircraft icon (with the nose representing present position)
- Nav range ring
- Flight plan legs
- Topography scale
- Topography data
- XM NEXRAD Weather (Optional)
- ChartView Overlay
- Terrain Overlay
- Traffic Overlay

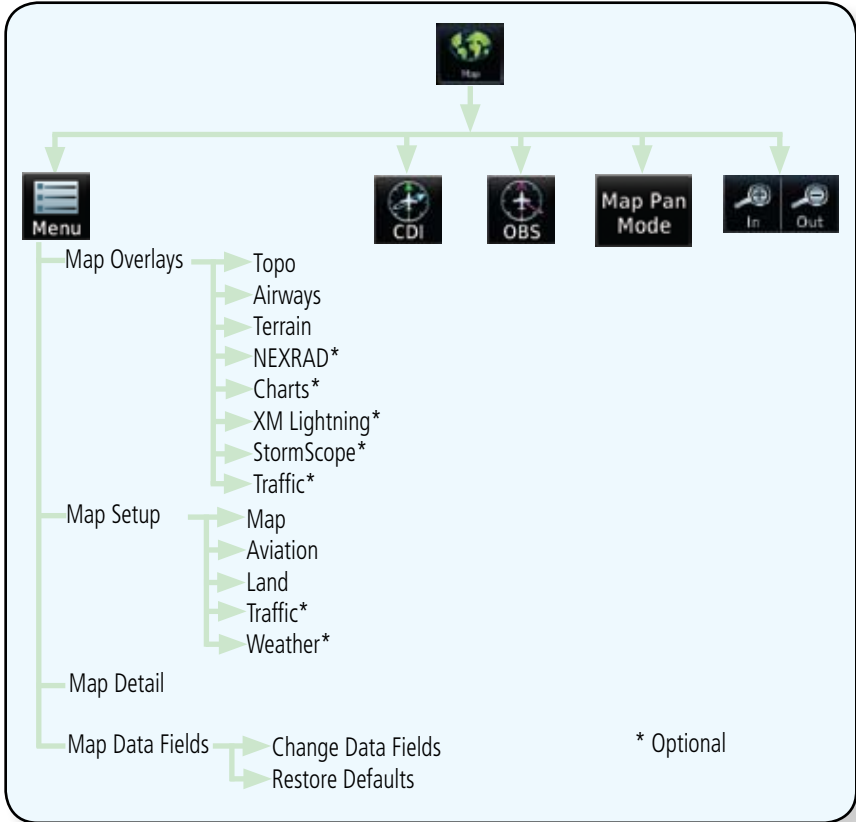

**Figure 9-1 Map Page Description**

Foreword  
Getting Started  
Audio & Xpdr Ctrl  
Com/Nav  
FPL  
Direct-To  
Proc  
Charts  
Wpt Info  
Map  
Traffic  
Terrain  
Weather  
Nearest  
Music  
Utilities  
System  
Messages  
Symbols  
Appendix



**NOTE:** The electronic map is an aid to navigation and is designed to facilitate the use of authorized government charts, not replace them. Land and water data is provided only as a general reference. The accuracy of the land and water data is not suitable for use as a primary source of navigation and should only be used to supplement official government charts and notices.



**Figure 9-2 Map Page Functional Diagram**



## 9.1 Map Menu

The Map Menu provides the ability to modify and control the information displayed on the Map page.

- Map Overlays are selected to overlay various types of information over the base map.
- Map Setup modifies the display of other map features.
- Map Data Fields determines whether or not the fields in the corners of the Map page are displayed and the data shown in each corner.
- Map Detail lets you control the amount of information displayed at different map ranges.
- Restore Defaults lets you start all over again with the default values for all Map page settings.



**NOTE:** Changes made in the Map Menu take effect immediately on the map display.

1. From the Home page, touch **Map** to reach the Map page, or press and hold the **HOME** key to go to the Map page from any function. On the Map page, touch the **Menu** key.

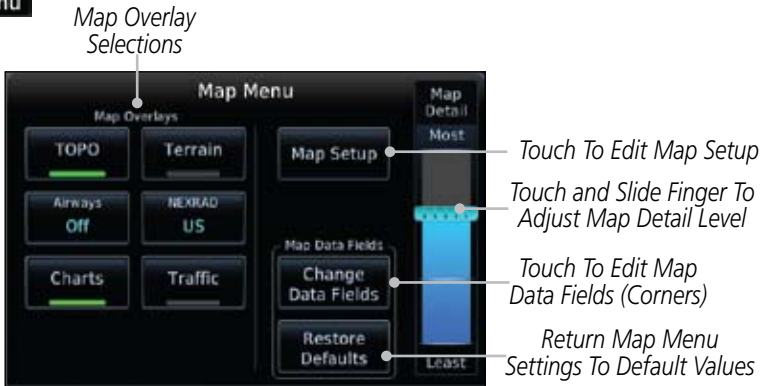
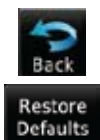

Figure 9-3 Map Menu

2. Touch the key for the desired option to access its settings.
3. Touch the **Back** key to return to the Map page. Any changes made will be retained until changed or the **Restore Defaults** key is touched.



## 9.1.1 Map Overlays

Map Overlays are layers of information that are referenced to geographic location and are overlaid on the base map. A green bar will appear below the Map Overlay key text when the overlay is selected, except for Airways.

### 9.1.1.1 Topo

The Topo Data option selects whether the colored topographical features are displayed. Traffic, Land Data, Terrain, and Obstacles will still be displayed even with Topo Data turned off.

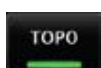

1. While viewing the Map Menu, touch the **TOPO** Map Overlay key to toggle the Topo setting.



Topo Map Overlay Off



Topo Map Overlay On

Figure 9-4 Topo Map Overlay Selections

2. When the Topo Map Overlay is toggled off, all topographic color features are removed.

## 9.1.1.2 Airways

The Airways option allows you to select the airways that are shown on the Map page. All, Low only, and High only Airways may be selected. When Off is selected, airways will not be shown.



1. While viewing the Map Menu, touch the **Airways** Map Overlay key to select the Airways viewed. Selections are: Off, Low, High, and All.



Figure 9-5 Map Menu Airways Map Overlay Selection

2. Low Airways are shown as grey lines. High Airways are shown as green lines.

### 9.1.1.3 Terrain

The Terrain Data option selects whether Terrain Data is shown on the Map page. Terrain and NEXRAD weather may not be displayed at the same time. Selecting one will disable the other. A Terrain icon will indicate that the Terrain overlay has been selected. Terrain overlay colors may or may not be shown depending on the altitude of the aircraft.



1. While viewing the Map Menu, touch the **Terrain** Map Overlay key to toggle the view of Terrain data.



- Red Terrain - At or Within 100 ft below Aircraft Altitude
- Yellow Terrain - Between 100 ft and 1000 ft below current aircraft altitude
- Current Position
- Icon Shows Terrain Overlay Is Active
- Touch to Zoom Map Range

**Figure 9-6 Map Menu Terrain Map Overlay "On" Selection**

2. The colors of the terrain are referenced to your aircraft altitude.

## 9.1.1.4 NEXRAD (Optional)

The NEXRAD menu option allows the display of NEXRAD weather information overlaid on the Map page. Terrain and NEXRAD weather may not be displayed at the same time. Selecting one will disable the other. NEXRAD weather is an optional feature that requires the installation of a GDL 69/69A and an XM Weather subscription. See the Weather section for more detail.

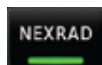

While viewing the Map Menu, touch the **NEXRAD** Map Overlay key to toggle the view of NEXRAD weather data.



NEXRAD Product Age

NEXRAD Weather

NEXRAD Weather

Figure 9-7 Map Menu NEXRAD Map Overlay "On" Selection

## 9.1.1.5 Charts (Optional)

The Charts menu option allows the display of Charts overlaid on the Map page.



**NOTE:** Opaque charts are displayed on top of other overlays, such as NEXRAD.

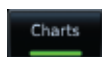

While viewing the Map Menu, touch the **Charts** Map Overlay key to toggle the view of the Charts overlay.

### 9.1.1.6 StormScope® (Optional)

The WX-500 StormScope Weather Mapping Sensor is a passive weather avoidance system that detects electrical discharges associated with thunderstorms within a 200 NM radius of the aircraft. The StormScope measures relative bearing and distance of thunderstorm-related electrical activity and reports the information to the display.



**NOTE:** Refer to the *WX-500 Pilot's Guide* for a detailed description of the *WX-500 StormScope*.

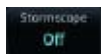

1. While viewing the Map Menu, touch the **StormScope** Map Overlay key to show the menu for selecting the StormScope radar weather data display mode (Cell, Strike, or Off).

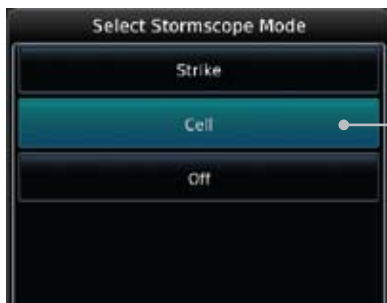

*Selected StormScope Data Display*

**Figure 9-8 Map Menu StormScope Map Overlay Selection**

2. StormScope data will be overlaid on the Map page when Cell or Strike is selected. See the Weather section for more details.



*Icon Shows StormScope Overlay Is Active*

**Figure 9-9 Map Menu StormScope Map Overlay On Selection**

## 9.1.1.7 Traffic (Optional)

The Traffic Map Overlay option selects whether Traffic data is shown on the Map page. A Traffic icon will indicate that the Traffic overlay has been selected. Traffic may or may not be shown depending on the other aircraft's location and equipment. See the Traffic section for more detail.



While viewing the Map Menu, touch the **Traffic** Map Overlay key to toggle the view of Traffic data.



*Non-Threat Traffic Indication. Currently 1200 Ft Above And Rising*

*Icon Shows Traffic Overlay Is Active*

Figure 9-10 Map Menu Traffic Map Overlay On Selection

## 9.1.2 Map Setup

The Map page is customized by selecting groups from the Map Menu. The Map Menu groups include choices for Map, Weather, Traffic, Aviation, and Land groups depending on the installed equipment of a given aircraft. Each group has a list of options that vary with the group.

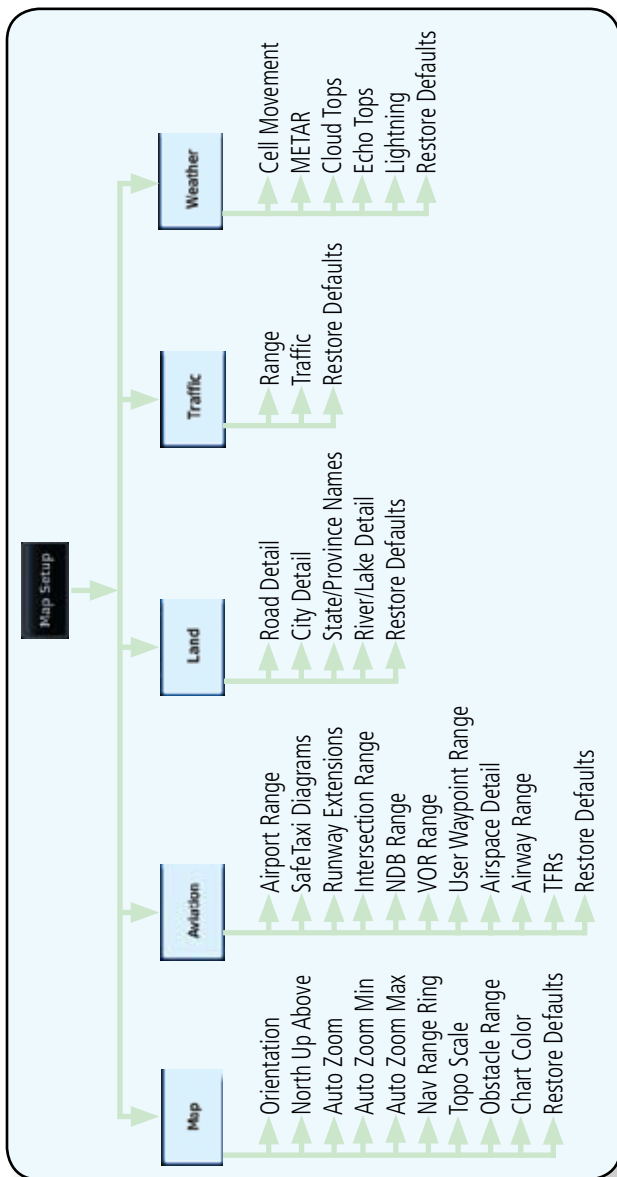

Figure 9-11 Map Setup Functional Diagram





1. While viewing the Map page, touch the **Menu** key. Then, touch the **Map Setup** key. The Map Setup page will be displayed.

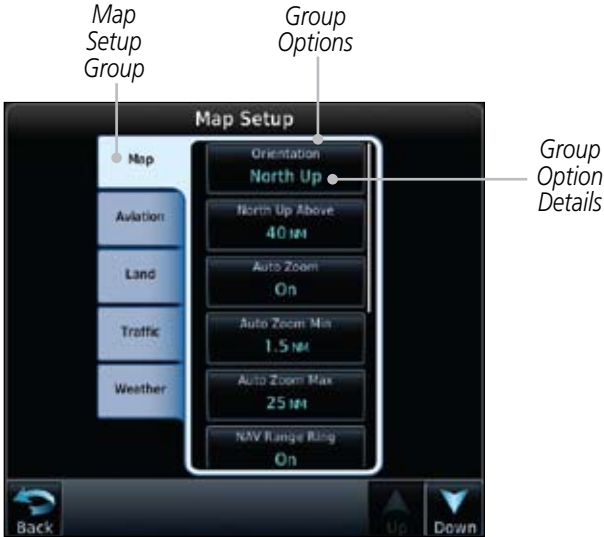

Figure 9-12 Map Setup Page

2. Touch the desired Map Setup Group tab (Map, Aviation, Land, Traffic, or Weather) to display the set of group options.
3. Touch the desired group key. A list of options for the selected group will be shown. (i.e. Map - Orientation, North Up Above, Auto Zoom, etc.) Touch the **Up** or **Down** keys as needed to scroll through the list.
4. Touch the key for the selected option.
5. Touch the **Restore Defaults** key to return to the original default values for the selected option.



## 9.1.2.1 Map

The Map option defines the behavior and display of information on the Map page such as: Orientation, North Up Above, Auto Zoom, Nav Range Ring, Topo Scale, Obstacle Range, and Restore Defaults. The default values are shown in **bold** type.

Feature	Selection
Orientation	North Up, <b>Track Up</b> , Heading Up
North Up Above	Off, 10 NM, 15 NM, 25 NM, <b>40 NM</b> , 50 NM, 75 NM, 100 NM, 150 NM, 250 NM
Auto Zoom	Off, <b>On</b>
Auto Zoom Min	250 ft, 400 ft, 500 ft, 750 ft, 1000 ft, 1500 ft, 2500 ft, 0.5 NM, 0.75 NM, 1 NM, <b>1.5 NM</b> , 2.5 NM, 4 NM, 5 NM, 7.5 NM, 10 NM, 15 NM, 25 NM, 40 NM, 50 NM, 75 NM, 100 NM, 150 NM, 250 NM, 400 NM
Auto Zoom Max	250 ft, 400 ft, 500 ft, 750 ft, 1000 ft, 1500 ft, 2500 ft, 0.5 NM, 0.75 NM, 1 NM, 1.5 NM, 2.5 NM, 4 NM, 5 NM, 7.5 NM, 10 NM, 15 NM, <b>25 NM</b> , 40 NM, 50 NM, 75 NM, 100 NM, 150 NM, 250 NM, 400 NM
Nav Range Ring	Off, <b>On</b>
Topo Scale	<b>Off</b> , On
Obstacle Range	Off, 4 NM, <b>5 NM</b> , 7.5 NM, 10 NM, 15 NM
Restore Defaults	Returns values to original factory settings

**Table 9-1 Map Setup Map Options**

## Map Orientation

The Map Orientation selection sets the orientation of the Map page. Selections are North Up, Track Up, and Heading Up. A Map Orientation label is shown below the North indicator in the top left corner of the Map page.



**Figure 9-13 Map Orientation Label**

## North Up Above

The North Up Above option allows you to select the map range where at and above the selected value the Map Orientation will automatically change to North Up as a default. When the map range is 500 NM or more, the map orientation will automatically become North Up.

## Auto Zoom

With a valid flight plan, the Auto Zoom feature will automatically change the Map page range depending on the distance to the next waypoint in the flight plan. If enabled, it will also automatically zoom to the SafeTaxi zoom range when the aircraft is on the ground. Auto Zoom can be overridden at any time by manually zooming with the **In** and **Out** keys. The Auto Zoom Min selection sets the minimum range that the display will Zoom in. The Auto Zoom Max value sets the maximum range the display will Zoom out.

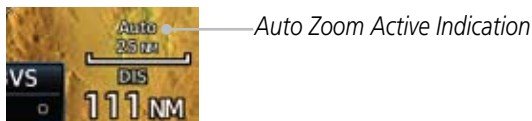

**Figure 9-14 Auto Zoom Active Indication**

Auto Zoom is re-enabled once one of the following conditions is met:

- A waypoint is sequenced
- the aircraft transitions from “on ground” to “in air”
- a point is reached where the Auto Zoom range matches the manual override range (known as auto-sync) and will be noted as “Auto” above the map range value on the map page
- Auto Zoom is toggled off and back on in the Map Setup page

## Auto Zoom Min

Set the limit that the display will zoom in automatically.



*Selected Minimum Auto Zoom Range*

**Figure 9-15 Map Setup Minimum Auto Zoom Range**

## Auto Zoom Max

Set the limit that the display will zoom out automatically.



*Selected Maximum Auto Zoom Range*

**Figure 9-16 Map Setup Maximum Auto Zoom Range**

## Nav Range Ring

When turned on, the Nav Range Ring option will show a ring with a compass rose around your present position on the Map page.

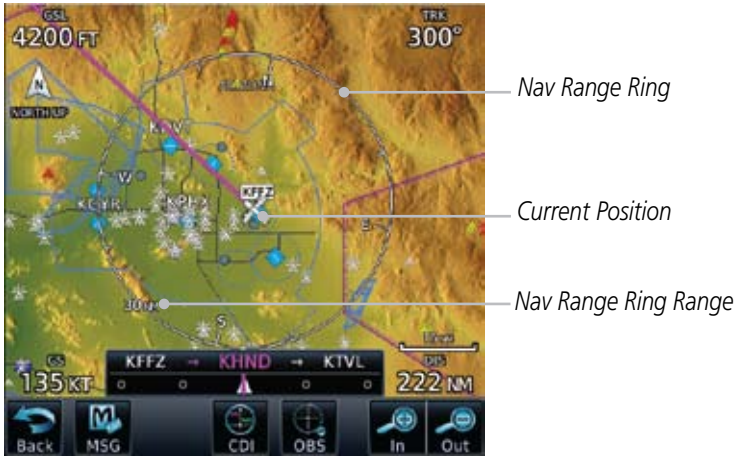

Figure 9-17 Nav Range Ring

## TOPO Scale

The Topo Scale option selects whether the elevation scale for topographical features on the Map page is displayed. The scale will be located on the right side of the display.



Figure 9-18 Map Page Topo Scale

Foreword

Getting Started

Audio & Xpdr Ctrl

Com/Nav

FPL

Direct-To

Proc

Charts

Wpt Info

Map

Traffic

Terrain

Weather

Nearest

Music

Utilities

System





Messages

Symbols

Appendix

## Obstacle Range

The Obstacle Range option selects whether the Obstacle Data is shown on the Map page at and below the selected Obstacle range. Map ranges above this value will not show the Obstacle Data.

	Unlighted Obstacle (Height is less than 1000 ft AGL)	Lighted Obstacle (Height is less than 1000 ft AGL)	Unlighted Obstacle (Height is greater than 1000 ft AGL)	Lighted Obstacle (Height is greater than 1000 ft AGL)
				
Foreword				
Getting Started				
Audio & Xpdr Ctrl				
Com/Nav				
FPL				

**Figure 9-19 Navigation Map Obstacle Icons**

1. While viewing the Map function, touch the **Menu** key.
2. Touch the **Map Setup** key.
3. Under the **Map** tab touch the **Obstacle Range** key and select the maximum range where obstacles will be displayed.

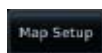

**Figure 9-20 Navigation Map Obstacles**

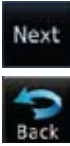

4. Touch an obstacle on the map and the elevation will be shown. If there are nearby or overlaid objects (obstacle, airspace, airport, etc), touch the **Next** key to step through the nearby objects. Touch the **Back** key to return to the normal map view.



Figure 9-21 Obstacle Detail

## Chart Color Scheme

The Chart Color Scheme setting changes the day and night view of the Chart Overlay colors on the Map page.

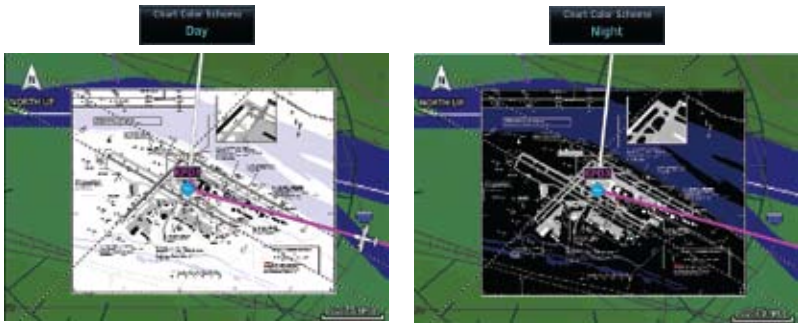

Figure 9-22 Chart Color Scheme Settings

## Restore Defaults

Returns values to the original factory settings.

## 9.1.2.2 Aviation

The Aviation group selection from the Map Setup Page Menu allows you to customize the display of Active Flight Plan, Active Flight Plan Waypoints, Airport size range, SafeTaxi information, Runway Extensions, Intersection/NDB locations, VOR locations, Airspace Detail, and TFR icons on the Map page. The feature will be shown at map ranges of the selected value and lower. The options for each feature are shown in the following table. The default values are shown in **bold** type.

Feature	Selection
Airport Range	Off, 7.5 NM, 10 NM, 15 NM, <b>25 NM</b> , 40 NM, 50 NM, 75 NM, 100 NM, 150 NM
SafeTaxi Diagrams	Off, 1000 ft, 1500 ft, 2500 ft, 0.5 NM, 0.75 NM, <b>1 NM</b> , 1.5 NM
Runway Extensions	Off, 1 NM, 1.5 NM, 2.5 NM, 4 NM, <b>5 NM</b>
Intersection Range	Off, 0.75 NM, 1 NM, 1.5 NM, 2.5 NM, <b>4 NM</b> , 5 NM, 7.5 NM, 10 NM
NDB Range	Off, 0.75 NM, 1 NM, 1.5 NM, 2.5 NM, 4 NM, <b>5 NM</b> , 7.5 NM, 10 NM
VOR Range	Off, <b>10 NM</b> , 15 NM, 25 NM, 40 NM, 50 NM, 75 NM, 100 NM
User Wpt Range	Off, 0.75 NM, 1 NM, 1.5 NM, 2.5 NM, 4 NM, <b>5 NM</b> , 7.5 NM, 10 NM, 15 NM, 25 NM, 40 NM, 50 NM, 75 NM, 100 NM
Airspace Detail	None, Least, Less, <b>Normal</b> , More, Most
Airway Range	2.5 NM, 4 NM, 5 NM, 7.5 NM, 10 NM, 15 NM, <b>25 NM</b>
TFRs	<b>Off</b> , On
Restore Defaults	Returns values to original factory settings

**Table 9-2 Map Setup Aviation Options**



**NOTE:** The term “intersection range” means any GPS waypoint included in the navigation database, and includes waypoints that may not be intersections of two VOR radials.



### 9.1.2.3 Land

The Land Data option selects whether detailed land features, such as Lat/Lon Grid, Freeways, National Highways, Local Roads, Cities, States/Provinces, and Rivers/Lakes are displayed. Topo features, traffic, terrain, and obstacles will still be displayed, even with Land Data turned off. The options for each feature are shown in the following table. The default values are shown in **bold** type.

Feature	Selection
Road Detail	None, Least, Less, <b>Normal</b> , More, Most
City Detail	None, Least, Less, <b>Normal</b> , More, Most
State/Province Names	Off, <b>On</b>
River/Lake Detail	None, Least, Less, <b>Normal</b> , More, Most
Restore Defaults	Returns values to original factory settings

Table 9-3 Map Setup Land Options

### 9.1.2.4 Airway Range

The Airways viewing range option selects whether the Airways are shown on the Map and at and below the selected map ranges for Low and High Airways. When Off is selected, the information will not be shown.

### 9.1.2.5 Traffic (Optional)

The Traffic group selection from the Map Setup Page Menu allows you to customize the display of traffic on the Map page. The Traffic function requires the installation of the appropriate traffic device. TIS and TAS cannot be displayed at the same time. If the aircraft has a TAS unit installed, the GTN unit will be configured for TAS. If no TAS unit is installed and a GTX Mode-S transponder is installed, the GTN unit will be configured for TIS. Coverage is limited to specific areas as shown in the AIM. TAS data comes from a TAS unit such as a Garmin GTS 800 or 820, Skywatch 497, KTA 810, or other unit. Coverage follows the airplane. In the Navigation Map page setup you can select the maximum range at which traffic symbols are shown. Once outside of the selected range, traffic will be decluttered. The default values are shown in **bold** type.

Traffic Selection	Display Result
Range	1 NM, 1.5 NM, 2.5 NM, 4 NM, 5 NM, 7.5 NM, 10 NM, 15 NM, <b>25 NM</b>
Traffic	<b>All Traffic</b> , PA/TA, TA Only
Restore Defaults	Returns values to original factory settings

**Table 9-4 Map Page Traffic Display Options**

## 9.1.2.6 Weather (Optional)

The Weather group selection from the Map Setup Page Menu allows you to customize the NEXRAD Viewing Range, NEXRAD Cell Movement, and XM Lightning Viewing range. Weather is an optional feature that requires a GDL 69/69A and an XM Weather subscription or WX-500 StormScope. The default values are shown in **bold** type.

Feature	Selection
Cell Movement	<b>Off</b> , On
METAR	<b>Off</b> , On
Cloud Tops	<b>Off</b> , On
Lightning	<b>Off</b> , On
Restore Defaults	Returns values to original factory settings

Table 9-5 Map Setup Weather Options

## 9.1.3 Map Data Fields

The Map Data Fields selection allows you to configure the data field type shown in each of the four corners of the Map page. The data shown in each field may be selected from a list after *Change Data Fields* is selected.



1. While viewing the Map page, touch the **Menu** key.



2. From the Map Menu screen, touch the **Change Data Fields** key.



Figure 9-23 Map Data Fields Selection

3. Touch the corner data field key you want to select. A list of information types will be displayed.

*Field Type List. Touch To Select Data Field*



*Slider Indicates More Selections Available. Press Finger and Slide To View More Selections.*

*Selected Field Type*

**Figure 9-24 Map Data Field Type Selections**



4. Touch the **Up** or **Down** keys or touch the display and drag your finger to scroll through the list. Touch the desired item to select it or touch the **Back** key to cancel selection.

Map Data Field Type	
BRG - Bearing to Current Waypoint	GSL - GPS Altitude
DIS - Distance to Current Waypoint	MSA - Minimum Safe Altitude
DIS to Dest - Distance to Destination	OAT (static) - Static Air Temperature
DTK - Desired Track	OAT (total) - Total Air Temperature
ESA - Enroute Safe Altitude	Time - Current Time
ETA - Estimated Time of Arrival	TKE - Track Angle Error
ETA at Dest - ETA at Destination	Trip Timer - Timers (Utilities)
ETE - Estimated Time Enroute	TRK - Track
ETE to Dest- ETE to Destination	VSR - Vertical Speed Required
Fuel Flow - Total Fuel Flow	Wind - Wind Speed and Direction
Generic Timer - Timers (Utilities)	XTK - Cross Track Error
GS - GPS Ground Speed	OFF - Do Not Display Data Field

**Table 9-6 Map Data Field Types of Information**

## 9.1.4 Map Detail

The Map Detail feature allows four levels of decluttering to remove map information. The declutter level is displayed in the **DCLTR** key. There are four levels of decluttering. Level 0 shows the most detail and level 3 shows the least detail.

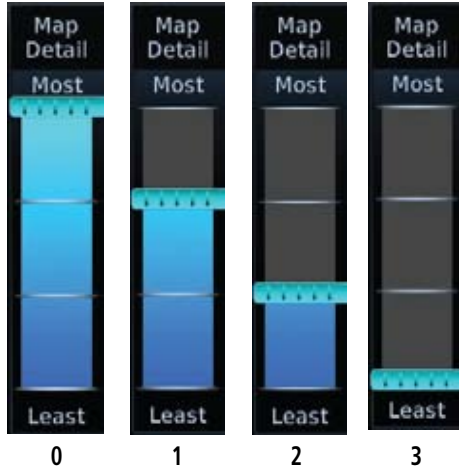

Figure 9-25 Map Detail Levels



1. While viewing the Map page, touch the **Menu** key.
2. While viewing the Map Menu, touch the **Map Detail** scale and slide your finger to adjust the level. Features marked with a • are shown at the indicated Map Detail Level.

Feature	0	1	2	3	Feature	0	1	2	3
					Tower	•	•		
River/Lake Names	•				TRSA	•	•		
Land/Country Text	•				ADIZ	•	•		
Large City	•				Alert Areas	•	•		
Medium City	•				Caution Areas	•	•		
Small City	•				Danger Areas	•	•		
Small Town	•				Warning Areas	•	•		
Freeways	•				Large Airports	•	•	•	
Highways	•				Medium Airports	•	•	•	
Roads	•				Restricted Areas	•	•	•	
Railroads	•				Prohibited Areas	•	•	•	
Political Boundaries	•				MOAs	•	•	•	
User Waypoints	•	•			Runway Labels	•	•	•	
Lat/Lon Grids	•	•			Lightning Strike Data	•	•	•	
VORs	•	•			NEXRAD Data	•	•	•	
NDBs	•	•			Traffic Symbols	•	•	•	
Intersections	•	•			Traffic Labels	•	•	•	
Class B Airspace	•	•			Water Detail	•	•	•	•
Class C Airspace	•	•			Active FPL Legs	•	•	•	•
Class D Airspace	•	•			Airways	•	•	•	•

**Table 9-7 Features Shown at Each Map Detail Level**

Foreword  
Getting Started  
Audio & Xpdr Ctrl  
Com/Nav  
FPL  
Direct-To  
Proc  
Charts  
Wpt Info  
**Map**  
Traffic  
Terrain  
Weather  
Nearest  
Music  
Utilities  
System  
Messages  
Symbols  
Appendix

## 9.2 Map Panning

In the Map Page function, panning allows you to move the map beyond its current limits without adjusting the map scale. The panning function is selected by simply touching the Map display. The **In** and **Out** keys at the lower right corner of the page control the map range. Touching the display momentarily switches the display to Map Pan Mode. While in Map Pan Mode, touch the display gently and drag your finger to pan around the map.

1. Touch the Map page display.

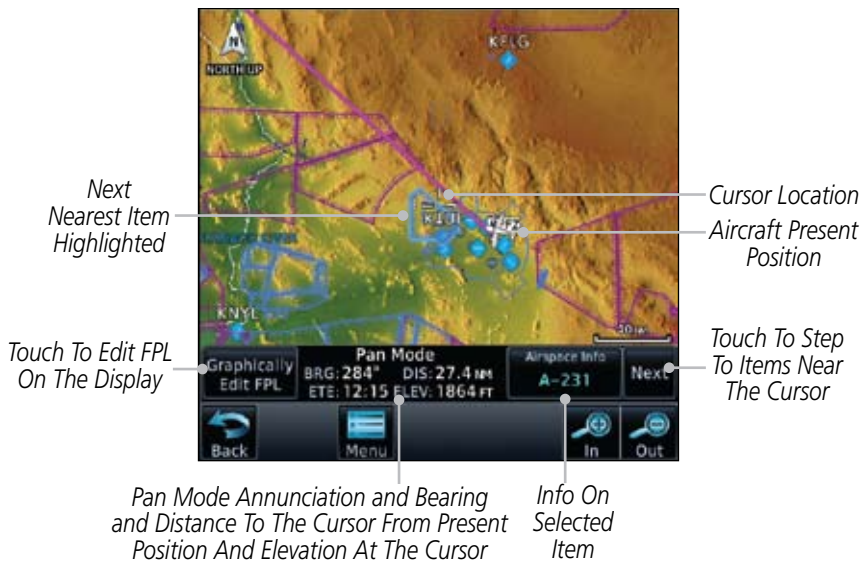

**Figure 9-26 Map Panning With Airspace Highlighted**

2. If you touch an item on the display (waypoint, airspace, obstacle) there may be other items very close that are difficult to see at a given zoom level. Touch the **Next** key to annunciate and highlight the next item. Each touch of the **Next** key steps to another item near the Map Pointer.



Foreword  
 Getting Started  
 Audio & Xpdr Ctrl  
 Com/Nav  
 FPL  
 Direct-To  
 Proc  
 Charts  
 Wpt Info  
**Map**  
 Traffic  
 Terrain  
 Weather  
 Nearest  
 Music  
 Utilities  
 System  
 Messages  
 Symbols  
 Appendix



**Figure 9-27 Map Panning With Next Airspace Shown**

3. Touch the **Airspace Info** (Item) key for more information about the selected item. Touch the **Back** key to return to the Map Panning display.



**Figure 9-28 Map Panning Selected Item Information**



4. While pressing your finger gently against the display, drag your finger across the display to scroll the display in the direction of your finger movement. The Map Pointer cross hair location is based on where your finger touches the display, but after dragging your finger the Map Pointer will be centered on the map when your finger is lifted from the display.



Figure 9-29 Map Panning With Map Pointer



**NOTE:** Pressing the Direct-To key will use the Map Pointer location as the destination.



5. Touch the **Back** key to return to the normal map display.

## 9.3 Map Controls

While in the Map page function, several controls are available to manage the view and display of information. The **In** and **Out** keys at the lower right corner of the page control the map range. Touching the display momentarily switches the display to Map Pan Mode.

While in any of the Map function pages, touching the display starts **Pan Mode**. Options are available to Create a waypoint at the Map Pointer position and to Graphically Edit Flight Plan.

### 9.3.1 Pan Map Mode

The Pan Map mode allows you to move the map display to view the surrounding area.

1. Touch the Map page display.
2. See the description in the Map Panning section for details of using this feature. Touch the **Back** key to return to the normal Map display.



### 9.3.2 Create Waypoint

The Create Waypoint function will create a User Waypoint at the Map Pointer location when that location is not an already named object, such as an airport or airspace.



1. In Pan Mode, touch the **Create Waypoint** key.
2. Follow the directions in the Waypoint Info section for Creating User Waypoints.



Figure 9-30 Create User Waypoint While Map Panning

## 9.3.3 Graphically Edit Flight Plan Mode

The Edit Flight Plan Mode allows making quick changes to the active flight plan directly on the display. The process is simply touching the display to start Map Pan Mode, touching the **Graphically Edit FPL** key, dragging the desired leg to a new waypoint or airway, and touching the **Done** key. At any point, a step may be removed by touching the **Undo** key or the whole process ended by touching the **Cancel** key. The **Undo** key will remove up to nine steps.

### 9.3.3.1 Adding a Waypoint Within an Existing Flight Plan

1. Touch the Map page display. The Map Mode selection keys will appear. Touch the **Graphically Edit FPL** key.

Graphically Edit FPL

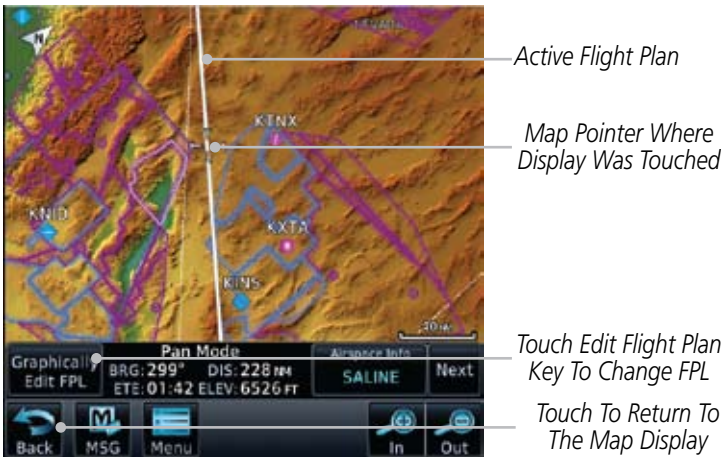

Figure 9-31 Edit Flight Plan Mode

2. Touch and hold the desired leg of the flight plan.

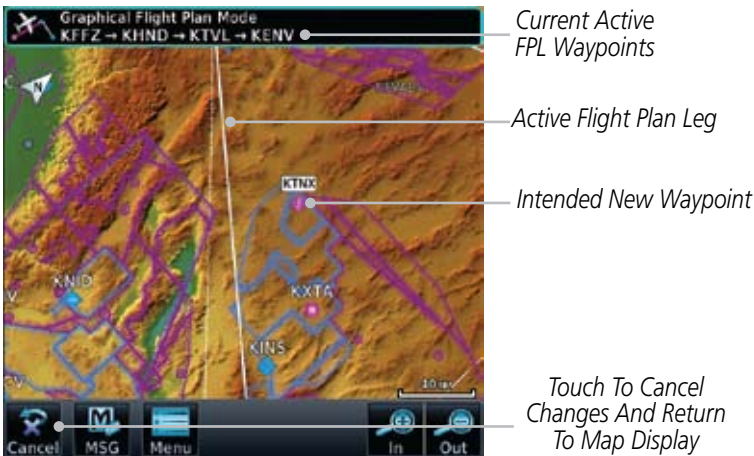

Figure 9-32 Select Leg of Flight Plan to Change

3. Drag the flight plan leg to a new waypoint, or airway, to add a waypoint, or airway, to the active flight plan. The flight plan leg being edited will turn cyan.



**Figure 9-33 Drag Selected Leg of Flight Plan to New Waypoint**

4. Touch the **Done** key. The aircraft will now navigate according to the new flight plan.



**Figure 9-34 Completed Flight Plan with New Waypoint**

**NOTE:** Parallel track will be cancelled when graphically editing a flight plan.



## 9.3.3.2 Adding a Waypoint to the End of an Existing Flight Plan

Graphically Edit FPL

1. Touch the Map page display. The Map Mode selection keys will appear. Touch the **Graphically Edit FPL** key.
2. Touch a waypoint that you want to add to the end of the flight plan.
3. Touch the **Done** key to accept the changes and return to the Map page.

Done

## 9.3.3.3 Removing a Waypoint from an Existing Flight Plan

Graphically Edit FPL

1. Touch the Map page display. The Map Mode selection keys will appear. Touch the **Graphically Edit FPL** key.
2. Touch a waypoint, or airway, on the flight plan that you want to remove.
3. Drag the flight plan line away from the waypoint, or airway, and release the line. The waypoint, or airway, will be removed from the flight plan.
4. Touch the **Done** key to accept the changes and return to the Map page.

Done

## 9.3.3.4 Creating a Flight Plan Without an Existing Flight Plan

Graphically Edit FPL

1. Touch the Map page display. The Map Mode selection keys will appear. Touch the **Graphically Edit FPL** key.
2. Touch a waypoint on the map to set the first waypoint in the flight plan. If there are several nearby waypoints, touch the desired waypoint to select it.



*Touch Desired Waypoint*

*Cluster Of Nearby Multiple Waypoints*

Figure 9-35 Select the Desired Waypoint From Multiple Waypoints

Foreword  
Getting Started  
Audio & Xpdr Ctrl  
Com/Nav  
FPL  
Direct-To  
Proc  
Charts  
Wpt Info  
Map  
Traffic  
Terrain  
Weather  
Nearest  
Music  
Utilities  
System  
Messages  
Symbols  
Appendix



*New FPL Waypoint*

*Touch To Undo Last Step*

**Figure 9-36 Start New Flight Plan with Origin Waypoint**

3. Touch a waypoint, or airway, on the map for the next waypoint, or airway, in the flight plan. Continue adding waypoints, or airways, as needed.



*New Active FPL*

*New FPL Waypoint*

*Active Flight Plan Leg*

*Touch To Undo Last Step*

*Touch To Cancel Editing*

*Touch To Accept Changes To FPL*

**Figure 9-37 Add New Waypoint to Flight Plan**

4. Touch the **Done** key to accept the changes and return to the Map page.



## 9.4 CDI (GTN 750 only)



The GTN 750's **CDI** key is used to couple the GPS or VLOC receiver to the external CDI (or HSI). When the external CDI (or HSI) is connected to the GPS receiver, “GPS” appears below the **CDI** key in the annunciation bar. When the external CDI (or HSI) is being driven by the VLOC receiver, “VLOC” appears instead.



**NOTE:** The external CDI (or HSI) must be coupled to the VLOC receiver for approaches which are not approved for GPS. See the ILS example in the Procedures section for more information.



**NOTE:** GPS phase of flight annunciations (LPV, ENR, etc.) are not applicable to the external CDI (or HSI) when VLOC is active.



**NOTE:** The internal on-screen CDI information is based on GPS data and cannot be used for primary navigation.



**NOTE:** If the unit is not configured for a CDI key, then the “activate GPS missed approach” will only resume automatic waypoint sequencing. The user must switch to GPS navigation, if desired, by using their external source selection method (this is typical an EFIS system).



1. The navigation source is annunciated under the **CDI** key.



Touch **CDI** Key To Toggle Navigation Source

Navigation Source Annunciation

**Figure 9-38** Navigation Source Selection



2. Touch the **CDI** key to toggle between sources.

## 9.5 OBS



The **OBS** key is used to select manual or automatic sequencing of waypoints. Touching this key selects OBS mode, which retains the current “active to” waypoint as your navigation reference even after passing the waypoint (i.e., prevents sequencing to the next waypoint). Touching the **OBS** key again returns to normal operation, with automatic sequencing of waypoints. Whenever OBS mode is selected, you may set the desired course To/From a waypoint using the pop-up window on the GTN 7XX or with the external OBS selector on your HSI or CDI. For leg types that do not support OBS, this key will be shown as a SUSP key. This key will then also function as an Unsuspend key for legs that auto-suspend, such as holds, missed approaches, etc.



**NOTE:** In dual GTN installations with crossfill on, the OBS course will only be updated real time on the GTN that is receiving the new OBS course. The course will be transferred to the other GTN when OBS is exited.

1. Touch the **OBS** key to enable the OBS function.
2. Enter the desired OBS heading using the keypad and touch **Enter**.
3. The OBS heading will be shown in the flight plan annunciation above the CDI in the lower portion of the display. The OBS function annunciation will show.

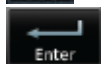

**Figure 9-39 OBS Course Selection**



## 9.6 Map Symbols

Various symbols are used to distinguish between waypoint types. The identifiers for any on-screen waypoints can also be displayed. Special-use and controlled airspace boundaries appear on the map, showing the individual sectors in the case of Class B, Class C, or Class D airspace. The following symbols are used to depict the various airports and nav aids on the Map Page:

Symbol	Description
	Airport with hard surface runway(s); Serviced, Primary runway shown
	Airport with hard surface runway(s); Non-Serviced, Primary runway shown
	Airport with soft surface runway(s) only, Serviced
	Airport with soft surface runway(s) only, Non-Serviced
	Unknown Airport
	Restricted (Private) Airfield
	Intersection
	VOR
	VORTAC
	VOR/DME
	TACAN
	DME
	NDB
	Locator Outer Marker
	Heliport

**Table 9-8 Map Symbols**

Foreword

Getting  
Started

Audio &  
Xpdr Ctrl

Com/Nav

FPL

Direct-To

Proc

Charts

Wpt Info

Map

Traffic

Terrain

Weather

Nearest

Music

Utilities

System

Messages

Symbols

Appendix

Index 9-36

Garmin GTN 725/750 Pilot's Guide

190-01007-03 Rev. B

*This page intentionally left blank*



### 10.1 Traffic Information Service (TIS) (Optional)



**WARNING:** The Traffic Information Service (TIS) is intended for advisory use only. TIS is intended to help the pilot locate traffic visually. It is the responsibility of the pilot to see and maneuver to avoid traffic.



**NOTE:** TIS is available only when the aircraft is within the service volume of a TIS-capable terminal radar site. Aircraft without an operating transponder are invisible to both Traffic Advisory Systems (TAS) and TIS. Aircraft without altitude reporting capability are shown without altitude separation data or climb/descent indication.



**NOTE:** TIS and Traffic Advisory System (TAS) may not both be configured at the same time.

Traffic Information Service (TIS) is designed to help in detection and avoidance of other aircraft. TIS uses the Mode S transponder for the traffic data link. TIS receives traffic information from ground stations, and is updated every five seconds. The GTN 7XX displays up to eight traffic targets within a 7.5 NM radius, from 3000 feet below to 3500 feet above the requesting aircraft.

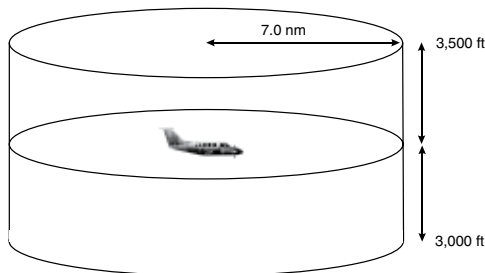





Figure 10-1 TIS Coverage Volume (not to scale)

## 10.1.1 TIS Symbology

Traffic is displayed according to TCAS symbology using three different symbols.

TIS Symbol	Description
	Non-Threat Traffic
	Traffic Advisory (TA)
	Traffic Advisory Off Scale

**Table 10-1 TIS Traffic Symbols**

Traffic Advisories (TA) alert the crew to intruding aircraft. When traffic meets the advisory criteria for the TA, a solid yellow circle symbol is generated. A Non-threat Advisory, shown as an open white diamond, indicates that an intruding aircraft is at greater than  $\pm 1200$  feet relative altitude or the distance is beyond five NM. A Traffic Advisory that is beyond the selected display range is indicated by a half TA symbol at the edge of the screen at the relative bearing of the intruder.

TIS also provides a vector line showing the direction in which the traffic is moving, to the nearest  $45^\circ$ . Traffic information for which TIS is unable to determine the bearing (non-bearing traffic) is displayed in the center of the Traffic Page or in a banner on maps other than the Traffic Map Page on which traffic can be displayed.

The altitude difference between the requesting aircraft and other intruder aircraft is displayed above/below the traffic symbol in hundreds of feet. If the other aircraft is above the requesting aircraft, the altitude separation appears above the traffic symbol with a "+" sign; if below, the altitude separation appears below. Altitude trend is displayed as an up/down arrow (for speeds greater than 500 fpm in either direction) to the right of the target symbol. Traffic symbols for aircraft without altitude reporting capability appear without altitude separation or climb/descent information.

Always remember that TIS cannot alert you to the presence of aircraft that are not equipped with transponders, nor can it alert you to aircraft that may be nearby, but obscured from the ground surveillance radar by interfering terrain.

## 10.1.2 Traffic Page

The Traffic Map Page is configured to show surrounding TIS traffic data in relation to the aircraft's current position and altitude, without clutter from the basemap. Aircraft orientation on this map is always heading up unless there is no valid heading.

The traffic mode is annunciated in the upper left corner of the Traffic Map Page. When the aircraft is on the ground, TIS automatically enters Standby Mode. Once the aircraft is airborne, TIS switches from Standby to Operating Mode and the GTN 7XX begins to display traffic information.

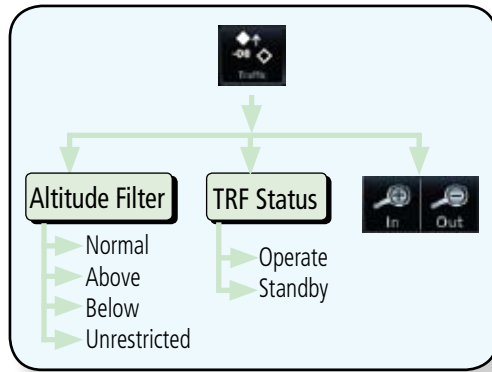

Figure 10-2 Traffic Page Functional Diagram

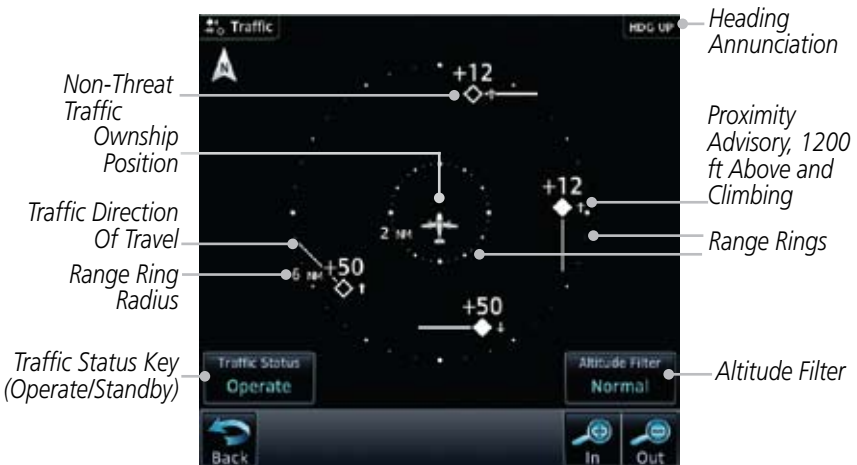

Figure 10-3 Traffic Page

## 10.1.3 Displaying Traffic on the Traffic Page

1. From the Home page, touch the **Traffic** key.
2. Confirm TIS is in Operating Mode.
3. Touch the **Traffic Status** key to toggle between Operate and Standby mode.

## 10.1.4 Altitude Display

1. While viewing the Traffic page, touch the **Operate** key to begin displaying traffic. "Operate" is displayed in the Traffic Status field.
2. Touch the **Altitude Filter** key to change the altitude volume. Select the desired altitude volume by touching the **BELOW**, **NORMAL**, **ABOVE**, or **UNRESTRICTED** keys. The selection is displayed in the Altitude mode field.



Figure 10-4 Traffic Altitude Filter Page

Altitude Mode	Displayed Traffic Range
Below	-9900 ft to 2700 ft
Normal	-2700 ft to 2700 ft
Above	-2700 ft to 9900 ft
Unrestricted	All Traffic Shown

Table 10-2 Displayed Traffic Range

## 10.1.5 TIS Limitations



**NOTE:** This section on TIS Limitations is not comprehensive. Garmin recommends the user review the TIS Limitations section of the Aeronautical Information Manual, Section 1-3-5.

TIS is NOT intended to be used as a collision avoidance system and does not relieve the pilot of responsibility to “see and avoid” other aircraft. TIS should not be used for avoidance maneuvers during IMC or other times when there is no visual contact with the intruder aircraft. TIS is intended only to assist in visual acquisition of other aircraft in VMC. No recommended avoidance maneuvers are provided for, nor authorized, as a direct result of a TIS intruder display or TIS advisory.

While TIS is a useful aid to visual traffic avoidance, it has some system limitations that must be fully understood to ensure proper use. Many of these limitations are inherent in secondary radar surveillance. In other words, the information provided by TIS will be no better than that provided to ATC. TIS will only display aircraft with operating transponders installed.

TIS relies on surveillance of the Mode S radar, which is a “secondary surveillance” radar similar to the ATCRBS. TIS operation may be intermittent during turns or other maneuvering. TIS is dependent on two-way, “line-of-sight” communication between the aircraft and the Mode S radar. Whenever the structure of the client aircraft comes between the transponder antenna (usually located on the underside of the aircraft) and the ground-based radar antenna, the signal may be temporarily interrupted. Other limitations and anomalies associated with TIS are described in the AIM, Section 1-3-5.



**Garmin is not responsible for Mode S geographical coverage. Operation of the ground stations is the responsibility of the FAA. Refer to the Aeronautical Information Manual for a Terminal Mode S Radar Site Map covering the U.S.**



**NOTE:** *TIS will be unavailable at low altitudes in many areas of the U.S., particularly in mountainous regions. Also, when flying near the “floor” of radar coverage in a particular area, intruders below the client aircraft may not be detected by TIS.*

TIS information is collected one radar scan prior to the scan during which the uplink occurs. Therefore, the surveillance information is approximately five seconds old. In order to present the intruders in a “real time” position, the TIS ground station uses a “predictive algorithm” in its tracking software. This algorithm uses track history data to extrapolate intruders to their expected positions consistent with the time of display in the cockpit. Occasionally, aircraft maneuvering will cause this algorithm to induce errors in the display. These errors primarily affect relative bearing information and traffic target track vector (it will lag); intruder distance and altitude will remain relatively accurate and may be used to assist in “see and avoid.” Some of the more common examples of these errors follow:

- When client or intruder aircraft maneuvers excessively or abruptly, the tracking algorithm may report incorrect horizontal position until the maneuvering aircraft stabilizes.
- When a rapidly closing intruder is on a course that crosses the client aircraft course at a shallow angle (either overtaking or head on) and either aircraft abruptly changes course within 0.25 NM, TIS may display the intruder on the opposite side of the client than it actually is.

**These are relatively rare occurrences and will be corrected in a few radar scans once the course has stabilized.**

- Foreword
- Getting Started
- Audio & Xpdr Ctrl
- Com/Nav
- FPL
- Direct-To
- Proc
- Charts
- Wpt Info
- Map
- Traffic**
- Terrain
- Weather
- Nearest
- Music
- Utilities
- System
- Messages
- Symbols
- Appendix
- Index



## 10.1.6 TIS Alerts

When the number of Traffic Advisories (TAs) on the Traffic Map Page increases from one scan to the next, the following occur:

- A single “Traffic” voice alert is generated.
- A TRAFFIC Annunciation appears at the bottom of the display, flashing for 5 seconds and remaining displayed until no TAs are detected in the area.

To reduce the number of nuisance alerts due to proximate aircraft, the “Traffic” voice alert is generated only when the number of TAs increases. For example, when the first TA is displayed, a voice and visual annunciation are generated. As long as a single TA remains on the display, no additional voice alerts are generated. If a second TA appears on the display or if the number of TAs initially decreases and then subsequently increases, another voice alert is generated.

A “Traffic Not Available” (TNA) voice alert is generated when the TIS service becomes unavailable or is out of range.

Traffic may not be displayed in the radar coverage area due to the following:

- Radar site TIS Mode S sensor is not operational or is out of service.
- Traffic or requesting aircraft is beyond the maximum range of the TIS-capable Mode S radar site.
- Traffic or requesting aircraft is above the radar site in the cone of silence and out of range of an adjacent site.
- Traffic or requesting aircraft is below radar coverage. In flat terrain, the coverage extends from about 3000 feet upward at 55 miles. Terrain and obstacles around the radar site can further decrease radar coverage in all directions.
- Traffic does not have an operating transponder.



## 10.1.7 TIS System Status

The GTN 7XX performs an automatic test of TIS during power-up. If TIS passes the test, TIS enters Standby Mode on the ground or Operating Mode in the air. If TIS fails the power up test, an annunciation is shown in the center of the Traffic Map Page. Contact a service center or Garmin dealer for corrective action for a failure message.

Traffic Page Annunciation	Description
No Data	Data is not being received from the transponder
Failed	The transponder has failed
Unavailable	TIS is unavailable or out of range

Table 10-3 TIS Failure Annunciations

The Traffic mode is annunciated in the bottom left corner of the Traffic Page. When the aircraft is on the ground, TIS automatically enters Standby Mode. Once the aircraft is airborne, TIS switches to Operating Mode and traffic information is displayed. The mode can be changed manually using the **Traffic Status** key.

Traffic Status	Traffic Mode Annunciation (Traffic On Map Page)	Traffic Display Enabled Icon (Other Maps)
TIS Operating	Operate	
TIS Standby	Standby	
TIS Failed*	TIS Fail	

\* Contact a service center or Garmin dealer for corrective action

Table 10-4 TIS Modes Shown on the Map Page

The annunciations that indicate the status of traffic information appear in a banner at the bottom center of maps on which traffic can be displayed.

Traffic Status Banner Annunciation	Description
<b>Traffic Coast 9 SEC</b>	<p>The displayed data is not current (6 to 12 seconds since last message).</p> <p>The quality of displayed traffic information is reduced when this message is displayed.</p>
<b>Traffic Removed</b>	<p>Traffic is removed because it is too old for coasting (12 to 60 seconds since last message).</p> <p>Traffic may exist within the selected display range, but it is not displayed.</p>

**Table 10-5 TIS Traffic Status Annunciations**

- Foreword
- Getting Started
- Audio & Xpdr Ctrl
- Com/Nav
- FPL
- Direct-To
- Proc
- Charts
- Wpt Info
- Map
- Traffic**
- Terrain
- Weather
- Nearest
- Music
- Utilities
- System
- Messages
- Symbols
- Appendix

## 10.2 TAS Traffic (Optional)



**NOTE:** TIS and Traffic Advisory System (TAS) may not both be configured at the same time.

TAS data comes from a TAS unit such as a Garmin GTS 800 or 820, Skywatch 497, KTA 810, or other unit.

Refer to the appropriate Traffic Advisory System's Pilot's Guides for a detailed discussion of the respective traffic advisory system.

The type of traffic systems that is installed is described by the Traffic Page keys. If a Traffic Advisory System (TAS) is configured, a **Traffic Mode** and **Altitude Filter** key will be displayed.



**NOTE:** Pilots should be aware of TAS system limitations. TAS systems require transponders of other aircraft to respond to system interrogations. If the transponders do not respond to interrogations due to phenomena such as antenna shading or marginal transponder performance, traffic may be displayed intermittently, or not at all. Aircraft without altitude reporting capability are shown without altitude separation data or climb descent indication. Pilots should remain vigilant for traffic at all times.



**WARNING:** The Traffic Advisory System (TAS) is intended for advisory use only to aid the pilot in visually acquiring traffic. No avoidance maneuvers should be based solely upon TAS traffic information. It is the responsibility of the pilot in command to see and maneuver to avoid traffic.

A Traffic Advisory System (TAS) enhances flight crew situational awareness by displaying traffic information for transponder-equipped aircraft. The TAS also provides visual and aural traffic alerts including voice announcements to assist in visually acquiring traffic.

When the TAS is in Operating Mode, the unit interrogates the transponders of intruding aircraft while monitoring transponder replies. The TAS uses this information to derive the distance, relative bearing, and if reported, the altitude and vertical trend for each aircraft within its surveillance range. The TAS then calculates a closure rate to each intruder based on the projected Closest Point of Approach (CPA). If the closure rate meets the threat criteria for a Traffic Advisory (TA), visual and aural alerting is provided.

## 10.2.1 TAS Symbology

Traffic Advisory System (TAS) is designed to help in detection and avoidance of other aircraft. TAS uses an on-board interrogator-processor to detect traffic. Only aircraft with operating transponders will be detected. Traffic is displayed according to TCAS symbology using four different symbols.





TAS Symbol	Description
	Non-Threat Traffic (intruder is beyond 5 NM and greater than 1200 ft vertical separation)
	Proximity Advisory (PA) (intruder is within 5 NM and less than 1200 ft vertical separation)
	Traffic Advisory (TA) (closing rate, distance, and vertical separation meet TA criteria)
	Traffic Advisory Off Scale

Table 10-6 TAS Intruder Symbol Description



Figure 10-5 Intruder Type, Altitude, and Vertical Trend

## 10.2.2 Displaying and Operating Traffic (TAS Systems)

The unit must be in Operating mode for traffic to be displayed. The ability to switch from Standby to Operating mode on the ground is especially useful for scanning the airspace around the airport before takeoff.

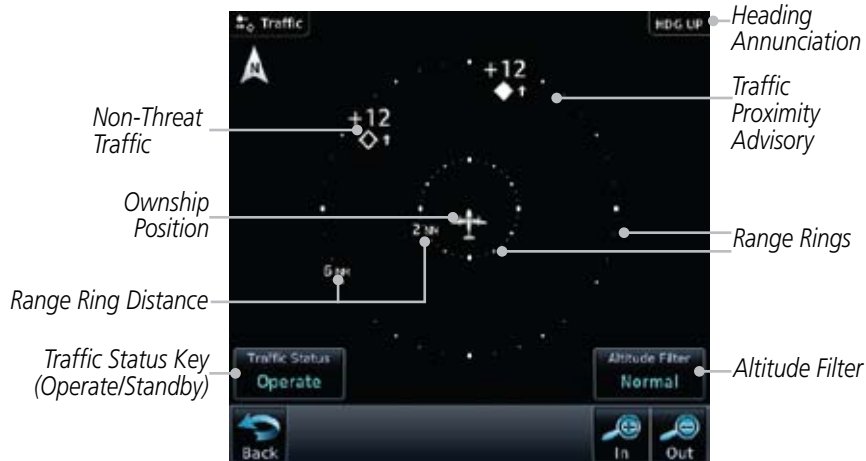

Figure 10-6 Traffic Page

### 10.2.2.1 Switching from Standby Mode to Operating Mode

1. From the Home page, touch the **Traffic** key.
2. Confirm TAS is in Operating Mode.
3. Touch the **Traffic Status** key to toggle between Operate and Standby mode.
4. Touch the **Altitude Filter** key to change the altitude volume.



**NOTE:** Not all TAS systems can be set to “Standby” mode while in the air.

The Traffic Page shows surrounding TAS traffic data in relation to the aircraft’s current position and altitude without basemap clutter. Aircraft orientation is always heading up unless no valid heading is received. The Traffic Status is announced in the lower left corner and the Altitude Filter is announced in the lower right corner.

## 10.2.2.2 Range Ring

Touching the **In** and **Out** keys will zoom in and out in preset steps depending on the installed equipment as shown in the following table.

Traffic Device	Map Ranges
Garmin GTS 800, Skywatch (SKY497/SKY889)	2 NM, 6 NM, 12 NM
Garmin GTS 820 and 850, Honeywell KTA 810 TAS, KTA 910 TAS, KMH 820 IHAS, KMH 920 IHAS, and Avidyne TAS 620 (Ryan 9900BX)	2 NM, 6 NM, 12 NM, 24 NM, 40 NM

Table 10-7 Available Traffic Range Ring Steps

## 10.2.3 Altitude Display



1. While viewing the Traffic page, touch the **Traffic Status** key to begin displaying traffic. "TAS OPERATING" is displayed in the Traffic mode field.



2. Touch the **Altitude Filter** key to change the altitude volume. Select the desired altitude volume by touching the **BELOW**, **NORMAL**, **ABOVE**, or **UNRESTRICTED** keys. The selection is displayed in the Altitude mode field.

Selected Altitude Filter



Figure 10-7 Traffic Altitude Filter Page

Altitude Mode	Displayed Traffic Range
Below	-9900 ft to 2700 ft
Normal	-2700 ft to 2700 ft
Above	-2700 ft to 9900 ft
Unrestricted	All Traffic Shown





**Table 10-8 Displayed Traffic Range**

## 10.2.4 Traffic System Status



**NOTE:** Refer to the equipment documentation for information on the self-test and operating modes.

The Traffic Status is indicated in the lower left corner of the Traffic Page.

Mode	Traffic Mode Annunciation (Traffic Page)	Traffic Display Enabled Icon (Other Maps)
TAS Self-test Initiated	Test	
TAS Operating	Operate	
TAS Standby	Standby	
TAS Failed	TAS Fail	

**Table 10-9 TAS Modes**

If the unit fails, an annunciation as to the cause of the failure is shown in the center of the Traffic Page.

Traffic Page Annunciation	Description
<b>No Data</b>	Data is not being received from the TAS unit
<b>Data Failed</b>	Data is being received from the TAS unit, but the unit is self-reporting a failure
<b>Failed</b>	Incorrect data format received from the TAS unit

**Table 10-10 TAS Failure Annunciations**



The annunciations to indicate the status of traffic information appear in a banner at the lower left corner of maps on which traffic can be displayed.

Traffic Status Banner Annunciation	Description
TA 6.0 + 03 ↓	System cannot determine bearing of Traffic Advisory. Annunciation indicates distance in NM, altitude separation in hundreds of feet, and altitude trend arrow (climbing/descending).
Failed	Traffic data has failed.
Data Fail	Data is being received from the transponder, but a failure is detected in the data stream.
No Data	Traffic has not been detected.

Table 10-11 TAS Traffic Status Annunciations

## 10.2.5 Traffic Pop-Up

When the GTN 7XX is displaying any page (other than the Traffic page) and a traffic alert becomes active, the Traffic Warning pop-up will be displayed.



**NOTE:** The traffic pop-up will not appear when your aircraft is on the ground.

- The traffic pop-up will appear on pages other than the Traffic page when a traffic alert occurs.



Figure 10-8 Traffic Pop-Up On the Map Page

- Foreword
- Getting Started
- Audio & Xpdr Ctrl
- Com/Nav
- FPL
- Direct-To
- Proc
- Charts
- Wpt Info
- Map
- Traffic**
- Terrain
- Weather
- Nearest
- Music
- Utilities
- System
- Messages
- Symbols
- Appendix
- Index



2. Touch the **Go to Traffic** key to view the Traffic page.

OR



3. Touch the **Close** key to close the pop-up. The pop-up will return if the traffic alert persists.

## 10.3 Traffic Test

The Traffic Test function is only available on some TAS traffic systems. The aircraft must be on the ground and Traffic Status must be in Standby.



1. Touch the **Test** key to activate the test function in the Traffic equipment.



*Test Traffic Status*  
*Touch For Traffic Test*  
*While In Standby*  
*Traffic Status*

**Figure 10-9 Traffic Test Mode**

2. The unit will return to normal operation mode after the test process is successfully completed.



### 11.1 Terrain Configurations

During power-up of the GTN 7XX, the terrain/obstacle database versions are displayed along with a disclaimer. At the same time, the Terrain system self-test begins. A failure message is issued if the terrain test fails.

Garmin provides the following terrain awareness solutions within the GTN 7XX environment:

- Terrain Proximity - This is the standard Terrain function and refers to the display of the relative terrain elevations on the moving map. No aural alerts of any type are provided by a Terrain Proximity configuration.
- TAWS-B (Optional) - A system developed to meet the terrain alerting and ground proximity requirements for Class B TAWS systems as defined in TSO-C151b. Garmin's GTN 7XX Terrain Awareness and Warning System (TAWS-B) is an optional feature and is intended to provide the flight crew with both aural and visual alerts to aid in preventing inadvertent Controlled Flight Into Terrain (CFIT).



**NOTE:** Obstacles are removed from the Terrain and TAWS pages at ranges greater than 10 NM.

### 11.2 Terrain Proximity

Garmin Terrain Proximity is a non-TSO-C151b-certified terrain awareness system provided as a standard feature of GTN 7XX to increase situational awareness and help reduce controlled flight into terrain (CFIT). Terrain may be displayed on the Map and Terrain pages.

Terrain Proximity uses information provided from the GPS receiver to provide a horizontal position and altitude. GPS altitude is derived from satellite measurements. GPS altitude is converted to a Mean Sea Level (MSL)-based altitude (GSL altitude) and is used to determine Terrain alerts. GSL altitude accuracy is affected by factors such as satellite geometry, but it is not subject to variations in pressure and temperature that normally affect pressure altitude devices. GSL altitude does not require local altimeter settings to determine MSL altitude. Therefore, GPS altitude provides a highly accurate and reliable MSL altitude source to calculate terrain and obstacle alerts.

Terrain utilizes terrain and obstacle databases that are referenced to mean sea level (MSL). Using the GPS position and GSL altitude, Terrain displays a 2-D picture of the surrounding terrain and obstacles relative to the position and altitude of the aircraft. In this manner, Terrain Proximity can provide advanced alerts of predicted dangerous terrain conditions.

Terrain requires the following to operate properly:

- The system must have a valid 3-D GPS position solution.
- The system must have a valid terrain/obstacle database.

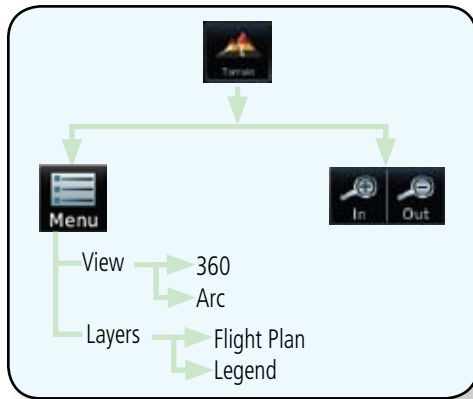

**Figure 11-1 Terrain Proximity Page Functional Diagram**

## 11.2.1 Displaying Terrain Proximity

The Terrain page is in the Terrain function.



1. Touch the **Terrain** key on the Home page.

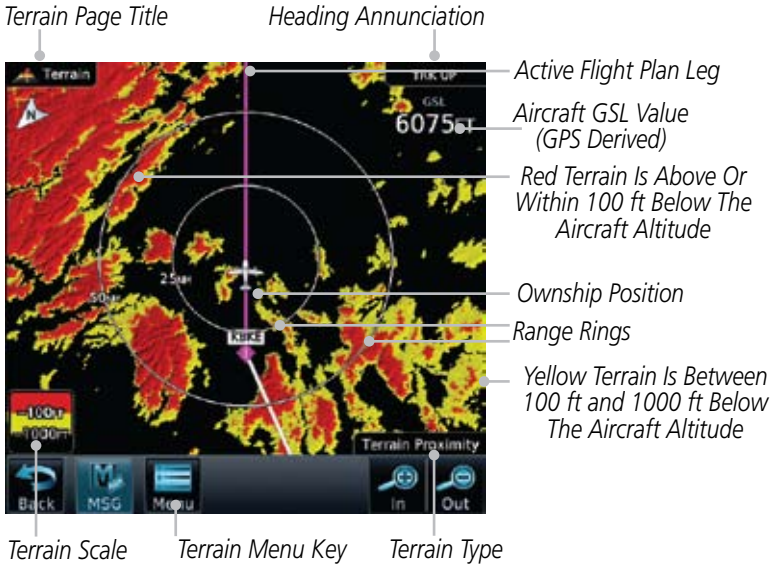

Figure 11-2 Terrain Page



2. Touch the **Menu** key for options.



Figure 11-3 Terrain Menu Options

### 11.2.1.1 Terrain Page 120° Arc or 360° Rings

Select the 120° Arc or 360° rings overlay for the Terrain page with either the **360** or **Arc** keys from the Menu.

1. While viewing the Terrain page, touch the **Menu** key.
2. Touch the **360°** or **Arc** key.

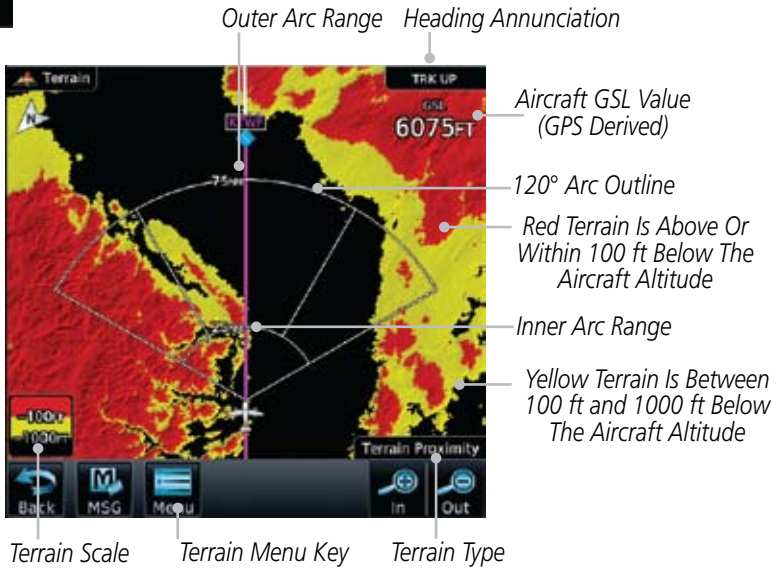
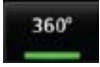

Figure 11-4 Terrain 120° Arc View

### 11.2.1.2 Display Flight Plan on Terrain Page

Select the display of the active flight plan on the Terrain page.

Touch the **Flight Plan** key to toggle the display of active flight plan on or off.

### 11.2.1.2 Display Terrain Legend

Select the display of the Terrain Legend on the Terrain page.

Touch the **Legend** key to toggle the display of the Terrain Legend on or off.

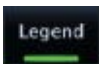

## 11.2.2 Terrain Limitations

Terrain Proximity displays terrain and obstructions relative to the altitude of the aircraft. The displayed alerts are advisory in nature only. Individual obstructions may be shown if available in the database. However, all obstructions may not be available in the database and data may be inaccurate. Terrain information should be used as an aid to situational awareness. Never use this information for navigation or to maneuver to avoid obstacles.

Terrain Proximity uses terrain and obstacle information supplied by government sources. The displayed information should never be understood as being all-inclusive.



---

**NOTE:** *The data contained in the Terrain databases comes from government agencies. Garmin accurately processes and cross-validates the data but cannot guarantee the accuracy and completeness of the data.*

---

Foreword

Getting Started

Audio & Xpdr Ctrl

Com/Nav

FPL

Direct-To

Proc

Charts

Wpt Info

Map

Traffic

Terrain

Weather

Nearest

Music

Utilities

System

Messages

Symbols

Appendix

## 11.3 Terrain Awareness and Warning System (TAWS-B) Optional

TAWS (Terrain Awareness and Warning System) is an optional feature to increase situational awareness and aid in reducing controlled flight into terrain (CFIT). TAWS provides visual and aural annunciations when terrain and obstacles are within the given altitude threshold from the aircraft.

TAWS satisfies TSO-C151b Class B requirements for certification. Class B TAWS is required for all Part 91 turbine aircraft operations with six or more passenger seats and for Part 135 turbine aircraft operations with six to nine passenger seats (FAR Parts 91.223, 135.154).

### 11.3.1 TAWS-B Requirements

TAWS requires the following to operate properly:

- A valid terrain/obstacle database
- A valid 3-D GPS position solution

### 11.3.2 TAWS-B Limitations



**NOTE:** *The data contained in the TAWS databases comes from government agencies. Garmin accurately processes and cross-validates the data but cannot guarantee the accuracy and completeness of the data.*

TAWS displays terrain and obstructions relative to the altitude of the aircraft. Compliance with TAWS B alerts and warnings is MANDATORY. When a TAWS B "pull up" annunciation is issued, the pilot is required to pull up.

TAWS uses terrain and obstacle information supplied by government sources. Terrain information is based on terrain elevation information in a database that may contain inaccuracies. Individual obstructions may be shown if available in the database. The data undergoes verification by Garmin to confirm accuracy of the content, per TSO-C151b.



### 11.3.3 Computing GPS Altitude for TAWS

TAWS uses information provided from the GPS receiver to provide a horizontal position and altitude. GPS altitude is derived from satellite measurements. GPS altitude is converted to a Mean Sea Level (MSL)-based altitude (GSL altitude) and is used to determine TAWS alerts. GSL altitude accuracy is affected by factors such as satellite geometry, but it is not subject to variations in pressure and temperature that normally affect pressure altitude devices. GSL altitude does not require local altimeter settings to determine MSL altitude. Therefore, GPS altitude provides a highly accurate and reliable MSL altitude source to calculate terrain and obstacle alerts.

The terrain and obstacle databases used by TAWS are referenced to Mean Sea Level. Using the GPS position and GSL altitude, TAWS displays a 2-D picture of the surrounding terrain and obstacles relative to the position and altitude of the aircraft. Furthermore, the GPS position and GSL altitude are used to calculate and “predict” the aircraft’s flight path in relation to the surrounding terrain and obstacles. In this manner, TAWS can provide advanced alerts of predicted dangerous terrain conditions.

### 11.3.4 Baro-Corrected Altitude Versus GSL Altitude

Baro-corrected altitude (or indicated altitude) is derived by adjusting the altimeter setting for local atmospheric conditions. The most accurate baro-corrected altitude can be achieved by frequently updating the altimeter setting to the nearest reporting station along the flight path. However, because actual atmospheric conditions seldom match the standard conditions defined by the International Standard Atmosphere (ISA) model (where pressure, temperature, and lapse rates have fixed values), it is common for the baro-corrected altitude (as read from the altimeter) to differ from the GSL altitude. This variation results in the aircraft’s true altitude differing from the baro-corrected altitude.

Foreword

Getting Started

Audio &amp; Xpdr Ctrl

Com/Nav

FPL

Direct-To

Proc

Charts

Wpt Info

Map

Traffic

Terrain

Weather

Nearest

Music

Utilities

System

Messages

Symbols

Appendix

## 11.3.5 Using TAWS

During unit power-up, the terrain/obstacle database versions are displayed. At the same time, TAWS self-test begins. One of the following aural messages is generated:

- “TAWS System Test OK” (not given if the aircraft is on the ground)
- “TAWS System Failure”

TAWS information can be displayed on the Map page. Terrain and obstacles with heights greater than 200 feet Above Ground Level (AGL) are displayed in yellow and red. The GTN 7XX adjusts colors automatically as the aircraft altitude changes.

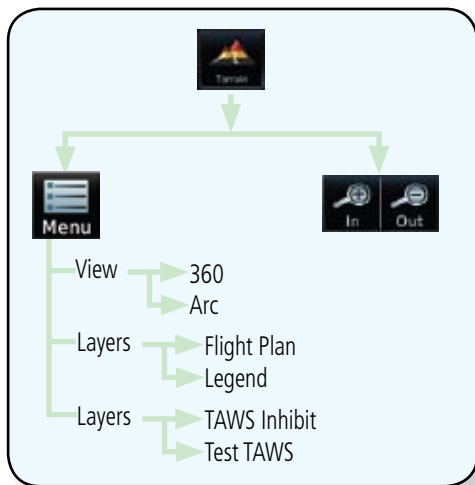
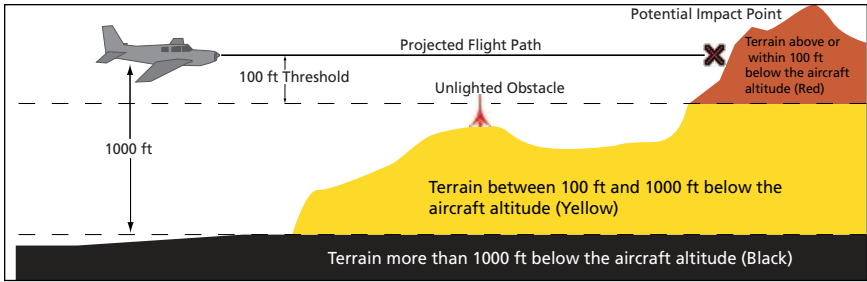

Figure 11-5 TAWS Page Functional Diagram

## 11.3.6 Displaying TAWS Data

TAWS uses yellow (caution) and red (warning) to depict terrain and obstacles alerts relative to aircraft altitude. Colors are adjusted automatically as the aircraft altitude changes. The colors and symbols shown below are used to represent terrain, obstacles, and potential impact points.



**Figure 10-6 Terrain Altitude/Color Correlation for Terrain Proximity**

Obstacle Symbol	Unlighted Obstacle		Lighted Obstacle		Potential Impact Points	Terrain Color	Terrain/Obstacle Location	Alert Level
	< 1000 ft AGL	> 1000 ft AGL	< 1000 ft AGL	> 1000 ft AGL				
					Red	Terrain/Obstacle at or within 100 ft below current aircraft altitude	WARNING (Red)	
					Yellow	Terrain/Obstacle between 100 ft and 1000 ft below current aircraft altitude	CAUTION (Yellow)	

**Table 11-1 TAWS Terrain/Obstacle Colors and Symbology**

### 11.3.7 TAWS Page

TAWS information is displayed on the Map and Terrain pages. The TAWS Page is specialized to show terrain, obstacle, and potential impact point data in relation to the aircraft's current altitude, without clutter from the basemap. Flight plan information (airports, VORs, and other NAVAIDs) included in the flight plan are displayed for reference. If an obstacle and the projected flight path of the aircraft intersect, the display automatically zooms in to the closest potential point of impact on the TAWS Page.

Aircraft orientation on this map is always heading up unless there is no valid heading. If orientation is not heading up, it will be track up. Two views are

available relative to the position of the aircraft: the 360° default display and the radar-like ARC (120°) display. Map range is adjustable with the **In** and **Out** keys from 1 to 200 NM, as indicated by the map range rings (or arcs).

### 11.3.7.1 Terrain Page Layers

1. While viewing the Terrain page, touch the **Menu** key.

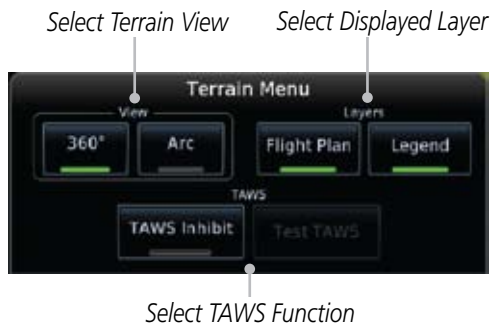

**Figure 11-7 Terrain Page Menu**

2. Touch the **Flight Plan** key to toggle the display of the active flight plan.

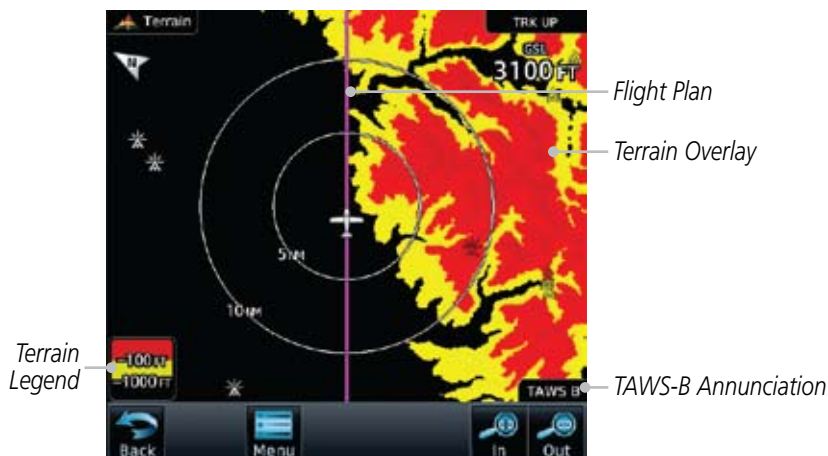

**Figure 11-8 Flight Plan and Legend Shown On Terrain Page**

3. Touch the **Legend** key to toggle the display of the terrain legend.

## 11.3.7.2 Terrain Page View

Select the 120° Arc or 360° rings overlay for the Terrain page with either the **360** or **Arc** keys from the Menu.



1. While viewing the Terrain page, touch the **Menu** key.



2. Touch the **360°** or **Arc** key.



## 11.3.7.3 Terrain Page TAWS Selections

The TAWS selections allow you to inhibit aural TAWS alerts and to send a request to the TAWS equipment to run its internal tests.



1. While viewing the Terrain page, touch the **Menu** key.



2. Touch the **TAWS Inhibit** key to toggle the inhibiting of TAWS alerts.

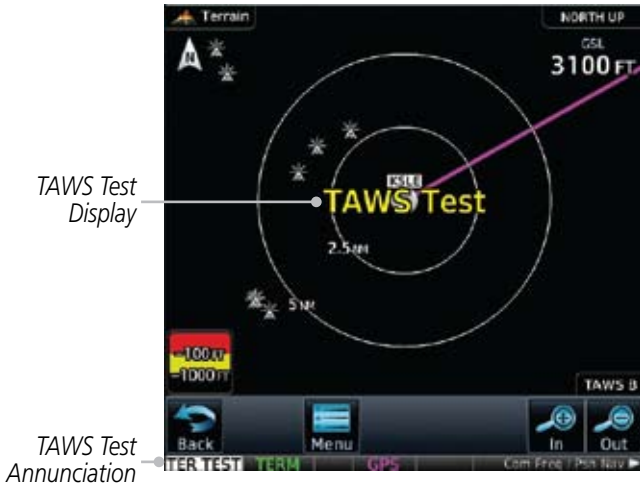

Figure 11-9 TAWS Alerts Inhibited Selected

- Foreword
- Getting Started
- Audio & Xpdr Ctrl
- Com/Nav
- FPL
- Direct-To
- Proc
- Charts
- Wpt Info
- Map
- Traffic
- Terrain**
- Weather
- Nearest
- Music
- Utilities
- System
- Messages
- Symbols
- Appendix
- Index

Test TAWS

3. Touch the **Test TAWS** key to test the TAWS system. This function is not available when the aircraft is in the air.



**Figure 11-10 TAWS Test Selected**

### 11.3.8 TAWS Alerts

Alerts are issued when flight conditions meet parameters that are set within TAWS software algorithms. When an alert is issued, visual annunciations are displayed and aural alerts are simultaneously issued. TAWS alert types are shown in the TAWS Alerts Summary with corresponding annunciations and aural messages.

When an alert is issued, annunciations appear on the TAWS page. If the TAWS page is not displayed at the time, a pop-up alert appears on the page being viewed.



**Figure 11-11 Terrain Alert Pop-Up**

## To acknowledge the pop-up alert:



Touch the **Go to Terrain** key (accesses the TAWS Page)

OR

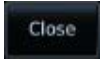

Touch the **Close** key to remove the pop-up alert

If the pilot takes no action, the pop-up will be removed when the alert is no longer active.

### 11.3.8.1 TAWS-B Alerting Colors and Symbology

Color and symbols are also associated with TAWS alerts. The alert annunciations show in the bottom left corner of the display. The three TAWS alert levels and their associated text coloring as well as any associated symbology are shown in the following table.

Alert Level	Annunciator Text	Potential Impact Point Symbol	Example Visual Annunciation
Warning	White text on red background		
Caution	Black text on yellow background		
Informational	Black text on white background	Not Applicable	

Table 11-2 TAWS Alert Colors and Symbology

	Alert Type	Alert Annunciation	Aural Message
Foreword			
Getting Started	Excessive Descent Rate Warning (EDR-W)	<b>PULL UP</b>	"Pull Up"
Audio & Xpdr Ctrl	FLTA Terrain Warning (RTC-W, ITI-W)	<b>PULL UP</b>	"Terrain Ahead, Pull Up; Terrain Ahead, Pull Up"* or "Terrain, Terrain; Pull Up, Pull Up"
Com/Nav			
FPL	FLTA Obstacle Warning (ROC-W, IOI-W)	<b>PULL UP</b>	"Obstacle Ahead, Pull Up; Obstacle Ahead, Pull Up"* or "Obstacle, Obstacle; Pull Up, Pull Up"
Direct-To			
Proc			
Charts	FLTA Terrain Caution (RTC-C, ITI-C)	<b>TERRAIN</b>	"Terrain Ahead; Terrain Ahead"* or "Caution, Terrain; Caution, Terrain"
Wpt Info	FLTA Obstacle Caution (ROC-C, IOI-C)	<b>OBSTCL</b>	"Obstacle Ahead; Obstacle Ahead"* or "Caution, Obstacle; Caution, Obstacle"
Map			
Traffic	Premature Descent Alert Caution (PDA)	<b>TERRAIN</b>	"Too Low, Terrain"
<b>Terrain</b>	Voice Callout (VCO-500)	None	"Five-Hundred"
Weather	Excessive Descent Rate Caution (EDR-C)	<b>TERRAIN</b>	"Sink Rate"
Nearest	Negative Climb Rate Caution (NCR-C)	<b>TERRAIN</b>	"Don't Sink"* or "Too Low, Terrain"
Music			
Utilities			

\* Alerts with multiple messages are configurable at installation and are installation-dependent. Alerts for the default configuration are indicated with asterisks.

**Table 11-3 TAWS-B Alerts Summary**



## 11.3.8.2 Excessive Descent Rate Alert

The purpose of the **Excessive Descent Rate (EDR)** alert is to provide notification when the aircraft is determined to be descending upon terrain at an excessive rate. The parameters for the alert as defined by TSO-C151b are shown below.

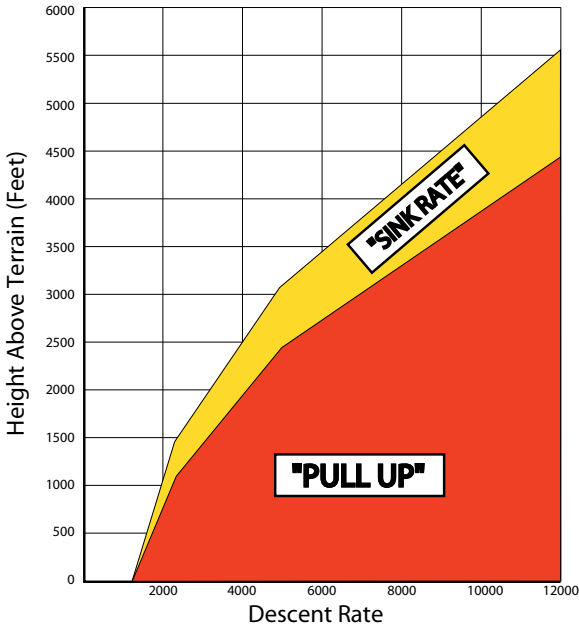

Figure 11-12 Excessive Descent Rate Alert Criteria

## 11.3.8.3 Forward Looking Terrain Avoidance

**Reduced Required Terrain Clearance (RTC)** and **Reduced Required Obstacle Clearance (ROC)** alerts are issued when the aircraft flight path is above terrain, yet is projected to come within the minimum clearance values in the FLTA Alert Minimum Terrain and Obstacle Clearance Values table. When an RTC alert and/or a ROC is issued, a potential impact point is displayed on the TAWS Page.

**Imminent Terrain Impact (ITI)** and **Imminent Obstacle Impact (IOI)** alerts are issued when the aircraft is below the elevation of a terrain or obstacle cell in the aircraft's projected path. ITI and IOI alerts are accompanied by a potential impact point displayed on the TAWS Page. The alert is annunciated when the projected vertical flight path is calculated to come within minimum clearance altitudes in the following table.

Flight Phase	Minimum Clearance Altitude (feet)	
	Level Flight	Descending
En Route	700	500
Terminal	350	300
Approach	150	100
Departure	100	100

**Table 11-4 FLTA Alert Minimum Terrain and Obstacle Clearance Values**

During final approach, FLTA alerts are automatically inhibited when the aircraft is below 200 feet AGL while within 0.5 NM of the approach runway or below 125 feet AGL while within 1.0 NM of the runway threshold.

### 11.3.8.4 Premature Descent Alerting

A Premature Descent Alert (PDA) is issued when the system detects that the aircraft is significantly below the normal approach path to a runway.

PDA alerting begins when the aircraft is within 15 NM of the destination airport and ends when the aircraft is either 0.5 NM from the runway threshold or is at an altitude of 125 feet AGL while within 1.0 NM of the threshold. During the final descent, algorithms set a threshold for alerting based on speed, distance, and other parameters.

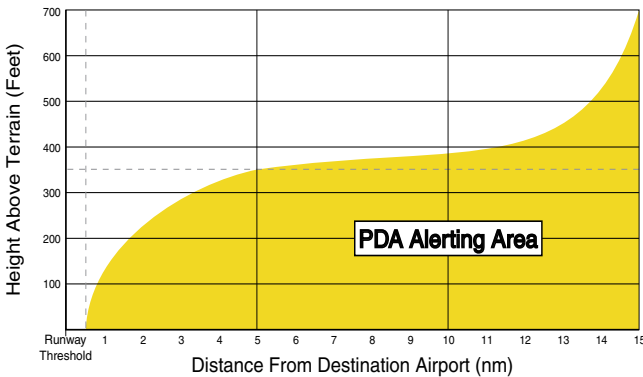

**Figure 11-13 PDA Alerting Threshold**

PDA and FLTA aural and visual alerts can be manually inhibited. Discretion should be used when inhibiting TAWS and the system should be enabled when appropriate. When TAWS is inhibited, the alert annunciation “TER INHB” is shown.

## 11.3.8.5 Inhibiting/Enabling TAWS Alerting

TAWS also has an inhibit mode that deactivates the PDA/FLTA aural and visual alerts. Pilots should use discretion when inhibiting TAWS and always remember to enable the system when appropriate. Only the PDA and FLTA alerts are disabled in the inhibit mode. After cycling power, TAWS will no longer be inhibited.



Figure 11-14 TAWS Alerting Disabled (TAWS Inhibited) Annunciation



1. While viewing the Terrain page, touch the **Menu** key.



2. Touch the **TAWS Inhibit** key to inhibit or enable TAWS (choice dependent on current state). A green bar in the key indicates the TAWS is inhibited.

## 11.3.8.7 Negative Climb Rate After Take-Off Alert (NCR)

The **Negative Climb Rate (NCR) After Take-Off** alert (also referred to as “Altitude Loss After Take-Off”) provides alerts when the system determines the aircraft is losing altitude (closing upon terrain) after takeoff. The aural message “Don’t Sink” is given for NCR alerts, accompanied by an annunciation and a pop-up terrain alert on the display. NCR alerting is only active when departing from an airport and when the following conditions are met:

- Height above the terrain is less than 700 feet
- Distance from the departure airport is 2 NM or less
- Heading change from the departure heading is less than 110°

The NCR alerting parameters as defined by TSO-C151b are shown below.

- Foreword
- Getting Started
- Audio & Xpdr Ctrl
- Com/Nav
- FPL
- Direct-To
- Proc
- Charts
- Wpt Info
- Map
- Terrain
- Weather
- Nearest
- Music
- Utilities
- System
- Messages
- Symbols
- Appendix
- Index

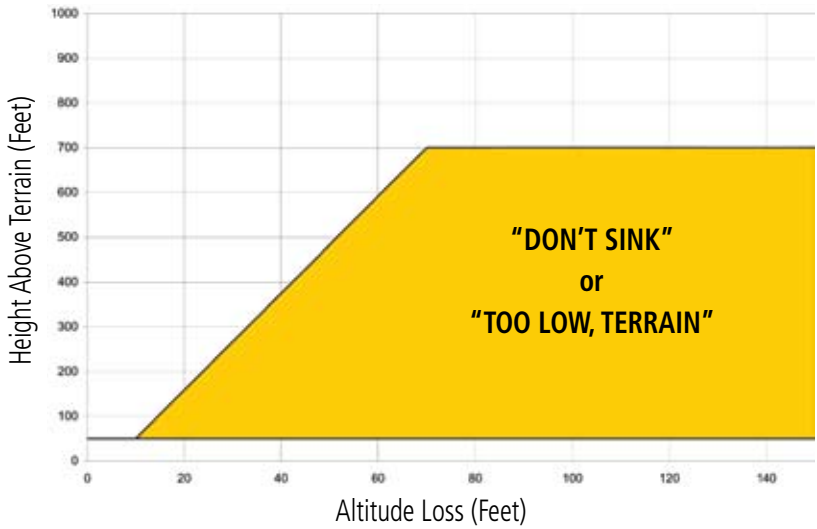

**Figure 11-15 Negative Climb Rate (NCR) Altitude Loss**

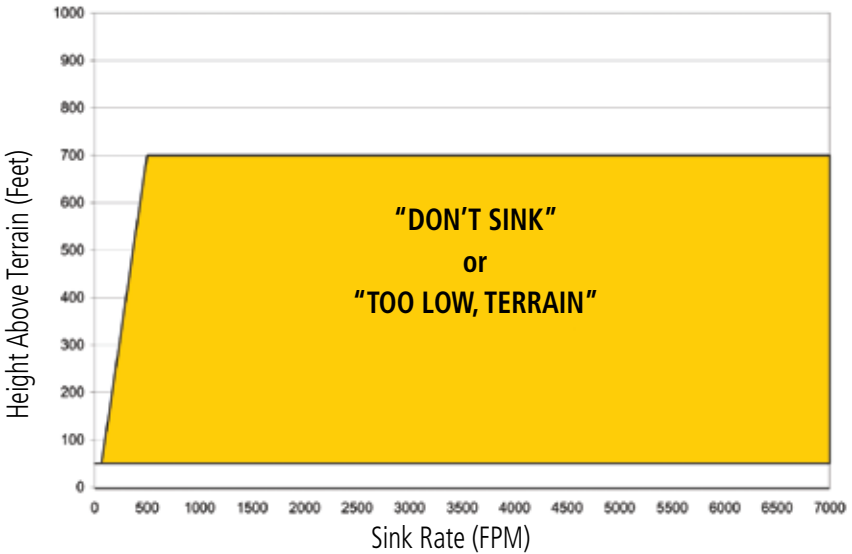

**Figure 11-16 Negative Climb Rate (NCR) Sink Rate**

### 11.3.8.8 TAWS Not Available Alert

TAWS requires a 3-D GPS position solution along with specific vertical accuracy minimums. Should the position solution become degraded or if the aircraft is out of the database coverage area, the annunciation “TAWS N/A” is generated in the annunciation window and on the TAWS page. The aural message “TAWS Not Available” is generated. When the GPS signal is re-established and the aircraft is within the database coverage area, the aural message “TAWS Available” is generated (when the aircraft is airborne).

### 11.3.8.9 TAWS Failure Alert

TAWS continually monitors several system-critical items such as database validity, hardware status, and GPS status. If the terrain/obstacle database is not available, the aural message “TAWS System Failure” is generated along with a “TAWS FAIL” annunciation.

## 11.3.9 TAWS System Status

During power-up, TAWS conducts a self-test of its aural and visual annunciations. The system test can also be manually initiated. An aural alert is issued at test completion. TAWS System Testing is disabled when ground speed exceeds 30 knots.

Alert Type	Alert Annunciation	Aural Message
TAWS Available	None	“TAWS Available”
TAWS System Test in Progress	<b>TER TEST</b>	None
TAWS System Test Pass	None	“TAWS System Test OK”
TAWS N/A	<b>TER N/A</b>	TAWS Not Available
TAWS Alerting is Disabled	<b>TER INHB</b>	None
TAWS System Test Fail	<b>TER FAIL</b>	“TAWS System Failure”

**Table 11-5 TAWS-B System Test Status Annunciations**

Foreword

Getting  
Started

Audio &  
Xpdr Ctrl

Com/Nav

FPL

Direct-To

Proc

Charts

Wpt Info

Map

*This page intentionally left blank*

Traffic

Terrain

Weather

Nearest

Music

Utilities

System

Messages

Symbols

Appendix



XM Weather data are displayed by the Weather Data Link function when an optional datalink is configured for weather or the StormScope® system is installed. The Wx Weather pages may be oriented to Track Up, Heading Up, or North Up.

When a weather product is active on Map function or the Weather Data Link function is selected, the age of the data is displayed on the screen. The age of the product is based on the time difference between when the data was assembled on the ground and the current GPS time. Weather products are refreshed at specific intervals (shown in the Product Age column on the right side of the Weather page). When two weather products are installed, a key for each product will be shown. Touch the key for the desired weather product. When a single weather product is installed, touching the **Weather** key will go directly to the Weather page.



Figure 12-1 Weather Product Selection

Foreword  
 Getting Started  
 Audio & Xpdr Ctrl  
 Com/Nav  
 FPL  
 Direct-To  
 Proc  
 Charts  
 Wpt Info  
 Map  
 Traffic  
 Terrain  
**Weather**  
 Nearest  
 Music  
 Utilities  
 System

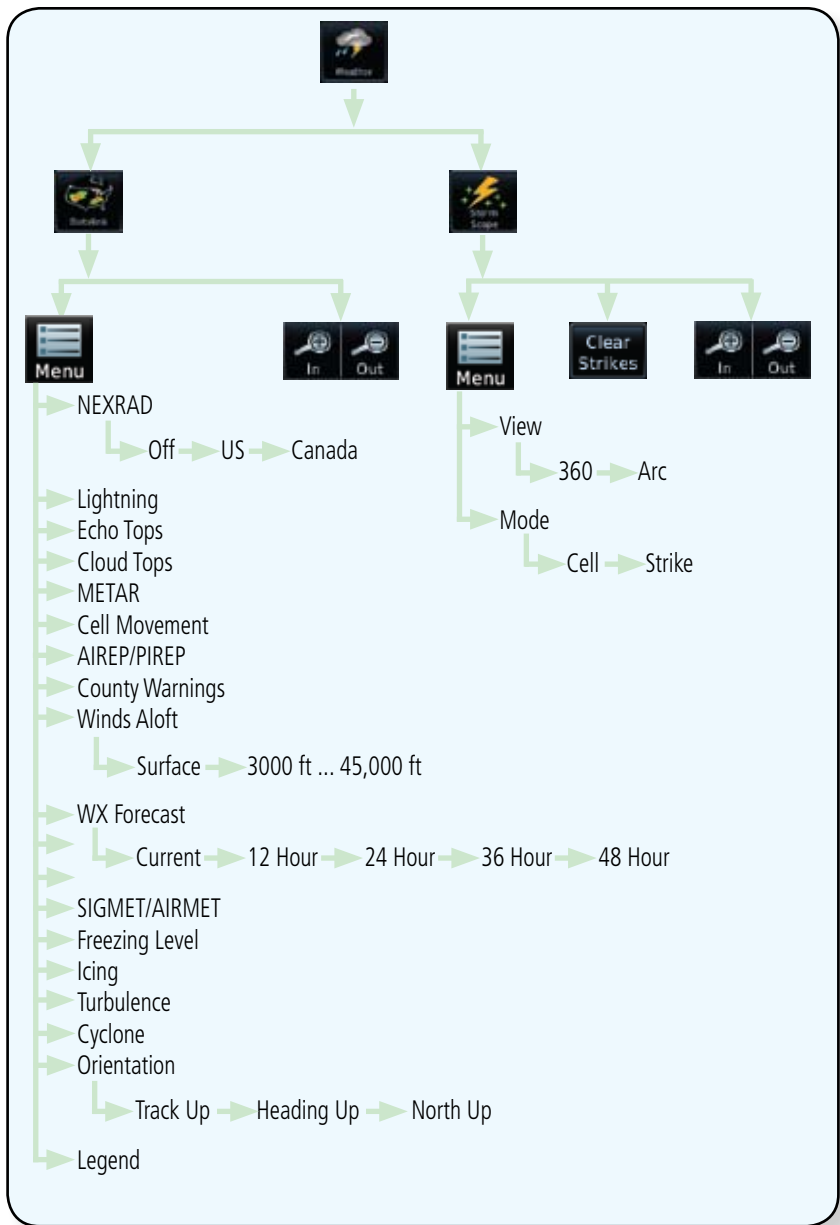

Figure 12-2 Datalink Weather Page Functional Diagram

Messages  
 Symbols  
 Appendix



## 12.1 XM Weather Products (Optional)

If for any reason, a weather product is not refreshed within the 30, 60, 90, or 120 minute Expiration Time intervals, the data is considered expired and is removed from the display. This ensures that the displayed data is consistent with what is currently being broadcast by XM Satellite Radio services. If more than half of the expiration time has elapsed from the time the data is received, the color of the product age displayed changes to yellow.

### 12.1.1 Displaying Data Link Weather

To display XM weather touch the **Weather** key on the Home page.

1. Touch the **Weather** key on the Home page and then touch the **Data Link** key.



Age Of Selected Weather Products

Out Of Coverage Area

Selected Altitude

Touch + or - To Select Altitude

Figure 12-3 Data Link Weather Page

Foreword  
Getting Started  
Audio & Xpdr Ctrl  
Com/Nav  
FPL  
Direct-To  
Proc  
Charts  
Wpt Info  
Map  
Traffic  
Terrain  
Weather  
Nearest  
Music  
Utilities  
System  
Messages  
Symbols  
Appendix



- While viewing the Data Link weather page, touch the **Menu** key to configure the Data Link Weather page.

*Touch NEXRAD Key To Select Off, US, or Canadian NEXRAD*



*Touch Keys To Select Weather Product. Green Bar Indicates Selected Product.*

*Weather Overlay Map Orientation*

*Touch Legend Key To Display Legend*

**Figure 12-4 Weather Data Link Menu**



- Once you selected what items you want to display, touch **BACK** to return to the Data Link Weather page.

## 12.1.2 Weather Legend

The **Legend** key displays a pop-up legend of the currently displayed weather products.



1. While viewing the Data Link Weather menu, touch the **Legend** key.

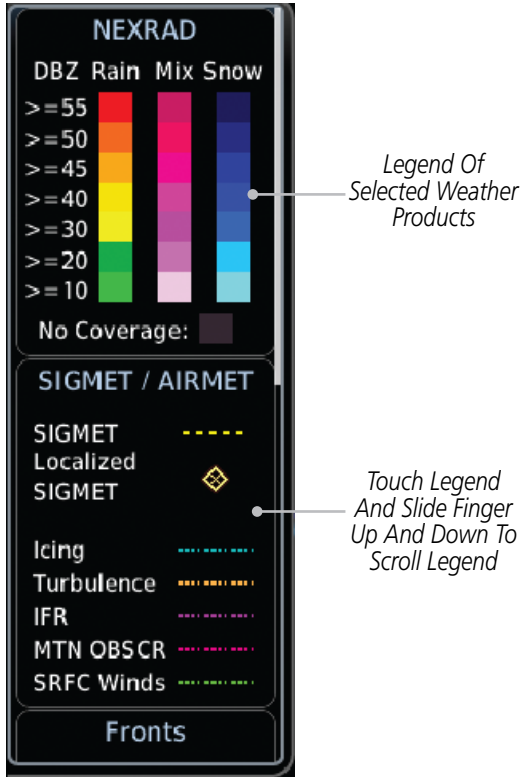

Figure 12-5 Weather Legend Display

2. Touch the Legend area of the display and while maintaining light pressure against the display, drag your finger up or down to scroll through the legend display for the selected weather products, or use the **Up/Down** keys.
3. Touch the **Legend** key again to remove the Legend.



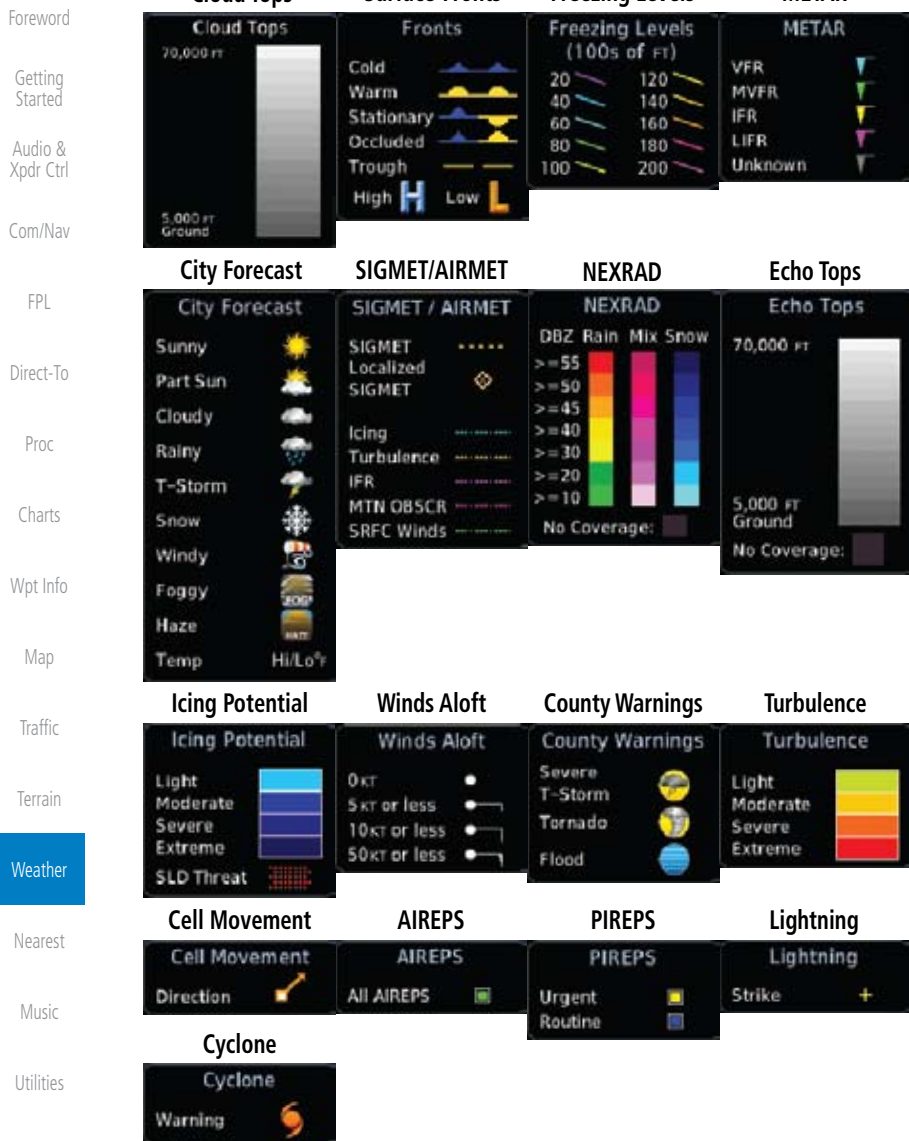

Figure 12-6 Available Weather Legends

### 12.1.3 Weather Map Orientation

1. While viewing the Weather Data Link function, touch the **Menu** key.
2. Touch the **Orientation** key to toggle the map view orientation choices of North Up, Track Up, and Heading Up



Messages

Symbols

Appendix

Index

## 12.1.4 XM Weather Symbols and Product Age













The weather product symbols, the expiration time and the refresh rate are shown in the following tables. The refresh rate represents the interval at which XM Satellite Radio broadcasts new signals that may or may not contain new weather data. It does not represent the rate at which weather data is updated or new content is received by the Data Link Receiver. Weather data is refreshed at intervals that are defined and controlled by XM Satellite Radio and its data vendors.

Weather Product	Expiration Time (Minutes)	Refresh Rate (Minutes)
NEXRAD (NEXRAD and Echo Top are Mutually Exclusive)	30	5 (U.S.) 10 (Canada)
Echo Top (Cloud Top and Echo Top Mutually Exclusive) (NEXRAD and Echo Top Mutually Exclusive)	30	7.5
Cloud Top (Cloud Top and Echo Top Mutually Exclusive)	60	15
XM Lightning	30	5
Cell Movement	30	1.25
SIGMETs / AIRMETs	60	12
METARs	90	12
City Forecast	90	12
WX Forecast	60	12
Freezing Levels	60	12
Winds Aloft	60	12
County Warnings	60	5
Cyclone Warnings	60	12
Icing Potential (Icing) (SLD)	90	22
Pilot Weather Report (PIREP) (Blue - Regular, Yellow - Urgent)	90	12
Air Report (AIREP)	90	12
Turbulence	180	12

Foreword  
Getting Started  
Audio & Xpdr Ctrl  
Com/Nav  
FPL  
Direct-To  
Proc  
Charts  
Wpt Info  
Map  
Traffic  
Terrain  
Weather  
Nearest  
Music  
Utilities  
System  
Messages  
Symbols  
Appendix  
Index

Weather Product	Expiration Time (Minutes)	Refresh Rate (Minutes)
Radar Coverage	30	5
Temporary Flight Restriction (TFR)	60	12
Terminal Aerodrome Forecast (TAF)	60	12

**Table 12-1 Weather Products and Aging Times**

Symbol	Description
	Flood
	Severe Thunderstorm
	Tornado
	Sunny
	Part Sun
	Cloudy
	Rainy
	T-Storm
	Snow
	Windy
	Foggy
	Haze
	High/Low Temp

**Table 12-2 Weather Symbols**

## 12.1.5 NEXRAD

WSR-88D, or NEXRAD (NEXT-generation RADAR), is a network of 158 high-resolution Doppler radar systems that are operated by the National Weather Service (NWS). NEXRAD data provides centralized meteorological information for the continental United States and selected overseas locations. The maximum range of a single NEXRAD radar site is 250 NM. The NEXRAD network provides important information about severe weather for air traffic safety.

NEXRAD data is not real-time. The lapsed time between collection, processing, and dissemination of NEXRAD images can be significant and may not reflect the current radar synopsis. Due to the inherent delays and the relative age of the data, it should be used for long-range planning purposes only. Never use NEXRAD data to penetrate hazardous weather. Instead, use it in an early-warning capacity of pre-departure and en route evaluation.

Composite data from all the NEXRAD radar sites in the United States is shown. Canadian radar data provided by Environment Canada. This data is composed of the maximum reflectivity from the individual radar sweeps. The display of the information is color-coded to indicate the weather severity level.



**NOTE:** Due to similarities in color schemes, the display of Echo Tops cannot be shown with Cloud Tops and NEXRAD.



1. While viewing the Datalink Weather menu, touch the **NEXRAD** key to step through the NEXRAD selections.



Figure 12-7 NEXRAD Weather

2. Repeated touches to the **NEXRAD** key will toggle between the Off, US, and Canada selections.

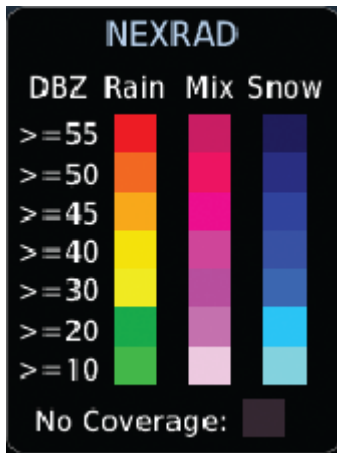
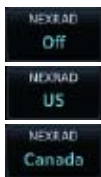

Figure 12-8 NEXRAD Weather Legend

### 12.1.5.1 Reflectivity

Reflectivity is the amount of transmitted power returned to the radar receiver. Colors on the NEXRAD display directly correlate to the level of detected reflectivity. Reflectivity as it relates to hazardous weather can be very complex.

The role of radar is essentially to detect moisture in the atmosphere. Simply put, certain types of weather reflect radar better than others. The intensity of a radar reflection is not necessarily an indication of the weather hazard level. For instance, wet hail returns a strong radar reflection, while dry hail does not. Both wet and dry hail can be extremely hazardous.

The different NEXRAD echo intensities are measured in decibels (dB) relative to reflectivity (Z). NEXRAD measures the radar reflectivity ratio, or the energy reflected back to the radar receiver (designated by the letter Z). The value of Z increases as the returned signal strength increases.

- Foreword
- Getting Started
- Audio & Xpdr Ctrl
- Com/Nav
- FPL
- Direct-To
- Proc
- Charts
- Wpt Info
- Map
- Traffic
- Terrain
- Weather**
- Nearest
- Music
- Utilities
- System
- Messages
- Symbols
- Appendix
- Index



## 12.1.5.2 NEXRAD Limitations

NEXRAD radar images may have certain limitations:

- NEXRAD base reflectivity does not provide sufficient information to determine cloud layers or precipitation characteristics. For example, it is not possible to distinguish between wet snow, wet hail, and rain.
- NEXRAD base reflectivity is sampled at the minimum antenna elevation angle. An individual NEXRAD site cannot depict high altitude storms at close ranges. It has no information about storms directly over the site.
- Each square block on the display represents an area of four square kilometers (2.15 NM<sup>2</sup>). The intensity level reflected by each square represents the highest level of NEXRAD data sampled within the area.

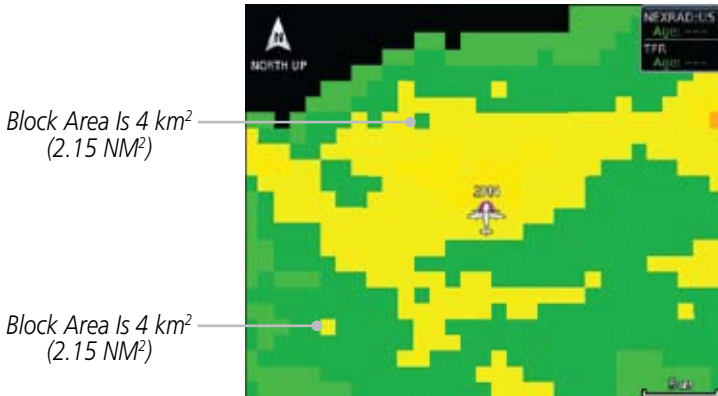

**Figure 12-9 NEXRAD Data Blocks**

The following may cause abnormalities in displayed NEXRAD radar images:

- Ground clutter
- Strokes and spurious radar data
- Sun strokes (when the radar antenna points directly at the sun)
- Interference from buildings or mountains, which may cause shadows
- Metallic dust from military aircraft, which can cause alterations in radar scans

## NEXRAD Limitations (Canada)

Foreword

- Radar coverage extends to 55°N.
- Any precipitation displayed between 52°N and 55°N is displayed as mixed because it is unknown.

Getting Started

Audio & Xpdr Ctrl

Com/Nav

FPL

Direct-To

Proc

Charts

Wpt Info

Map

Traffic

Terrain

Weather

Nearest

Music

Utilities

System

Messages

Symbols

Appendix

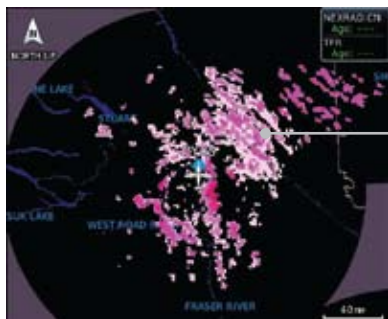

*Precipitation Above 52°N*

**Figure 12-10 NEXRAD Data - Canada**

Canadian radar data provided by Environment Canada.

## 12.1.6 Echo Tops

Echo Tops data shows the location, elevation, and direction of the highest radar echo. The highest radar echo does not indicate the top of a storm or clouds; rather it indicates the highest altitude at which precipitation is detected. This information is determined from NEXRAD data.



**NOTE:** Due to similarities in color schemes, the display of Echo Tops cannot be shown with Cloud Tops and NEXRAD.



1. While viewing the Data Link Weather menu, touch the **Echo Tops** key.

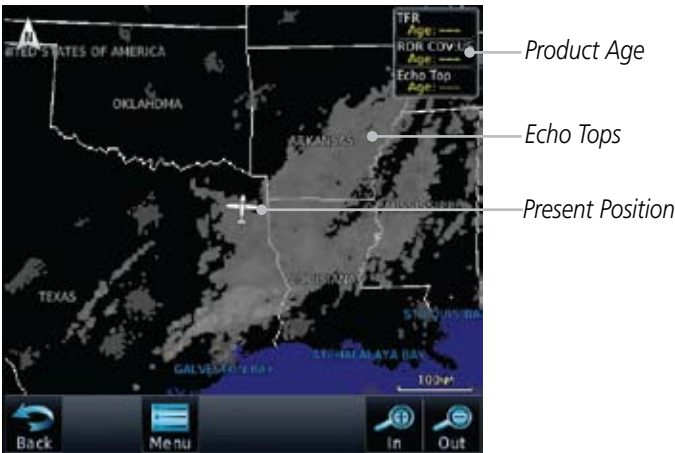

Figure 12-11 Echo Tops



2. Touch the **Echo Tops** key again to turn it off.

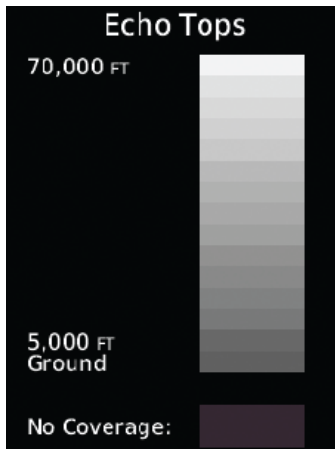

Figure 12-12 Echo Tops Legend

## 12.1.7 Cloud Tops



**NOTE:** Due to similarities in color schemes, it is not possible to display Echo Tops and Cloud Tops at the same time.

Cloud tops data depicts cloud top altitudes as determined from satellite imagery.



1. While viewing the Data Link Weather menu, touch the **Cloud Tops** key.



Figure 12-13 Cloud Tops

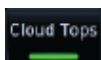

2. Touch the **Cloud Tops** key again to turn it off.

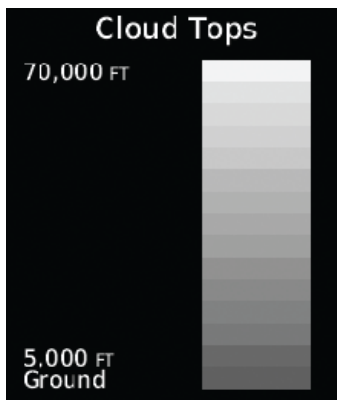

Figure 12-14 Cloud Tops Legend

## 12.1.8 Cell Movement

Cell Movement data shows the location and movement of storm cells as identified by a ground-based system. Cells are represented by yellow squares, with direction of movement indicated with short, orange arrows.



1. While viewing the Data Link Weather menu, touch the **Cell Movement** key.

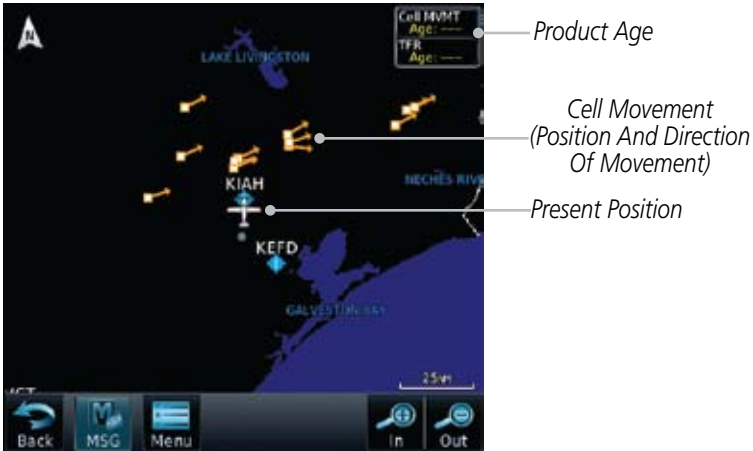

Figure 12-15 Cell Movement



2. Touch the **Cell Movement** key again to turn it off.



Figure 12-16 Cell Movement Legend

## 12.1.9 SIGMETs and AIRMETs

SIGMETs (SIGnificant METeoro logical Information) and AIRMETs (AIRmen's METeoro logical Information) are broadcast for potentially hazardous weather considered of importance to aircraft.



1. While viewing the Data Link Weather menu, touch the **SIGMET/AIRMET** key.



Figure 12-17 SIGMETs and AIRMETs



2. Touch the **SIGMET/AIRMET** key again to turn it off.



Figure 12-18 SIGMET/AIRMET Legend

## 12.1.10 County Warnings

County Warnings data provides specific public awareness and protection weather warnings from the National Weather Service. This can include information on fires, tornadoes, severe thunderstorms, flood conditions, and other natural disasters.

Foreword

Getting Started

Audio & Xpdr Ctrl

Com/Nav

FPL

Direct-To

Proc

Charts

Wpt Info

Map

Traffic

Terrain

Weather

Nearest

Music

Utilities

System

Messages

Symbols

Appendix



1. While viewing the Data Link Weather menu, touch the **County Warnings** key. Touch the County Warnings symbol for detailed information.

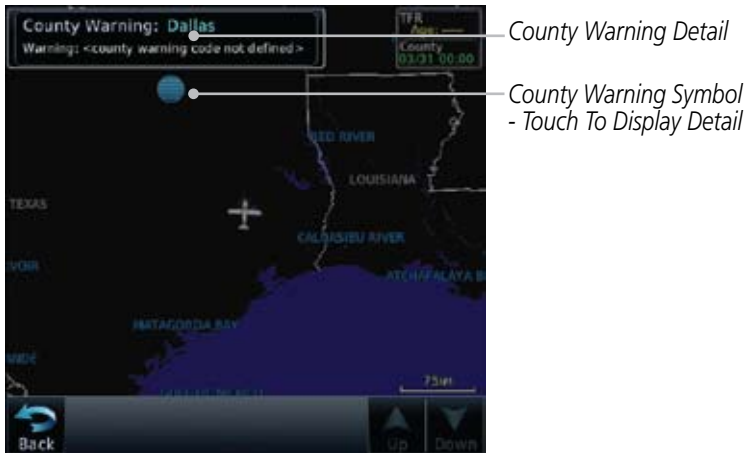

Figure 12-19 County Warnings Data



2. Touch the **County Warnings** key again to turn it off.

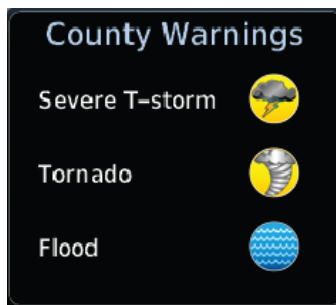

Figure 12-20 County Warnings Legend

## 12.1.11 Freezing Level

Freezing Level data shows the color-coded contour lines for the altitude and location at which the Freezing Level is found. When no data is displayed for a given altitude, the data for that altitude has not been received, or is out of date and has been removed from the display. New data appears on the next update.



1. While viewing the Data Link Weather menu, touch the **Freezing Level** key.



Figure 12-21 Freezing Level



2. Touch the **Freezing Level** key again to turn it off.



Figure 12-22 Freezing Level Legend



## 12.1.12 METARs

METAR (METeorological Aerodrome Report), known as an Aviation Routine Weather Report, is the standard format for current weather observations. METARs are updated hourly and are considered current. METARs typically contain information about the temperature, dew point, wind, precipitation, cloud cover, cloud heights, visibility, and barometric pressure. They can also contain information on precipitation amounts, lightning, and other critical data. METARs are shown as colored flags at airports that provide them.



1. While viewing the Data Link Weather menu, touch the **METAR** key. Touch an airport symbol for more METAR detail.

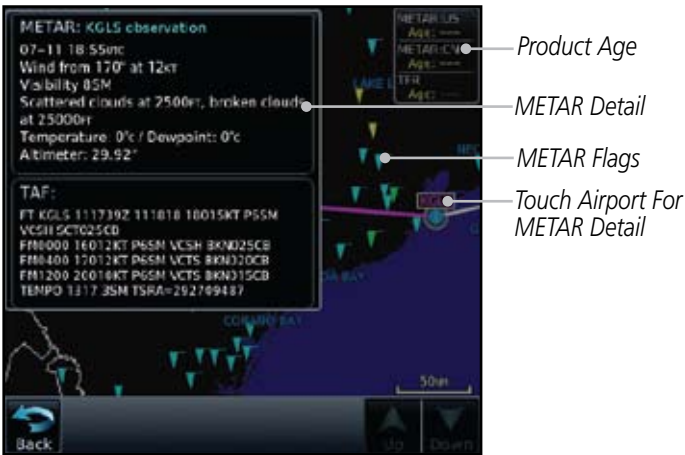
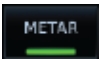

Figure 12-23 METARs



2. Touch the **METAR** key in the Menu again to turn it off.



Figure 12-24 METARs Legend

## 12.1.13 Cyclone

The current location of the cyclone is shown along with its projected path with the date and time.

1. While viewing the Data Link Weather menu, touch the **Cyclone** key.



*Projected Path With Date  
And Time*

*Current Position Of Cyclone*

**Figure 12-25 Cyclone**

2. Touch the **Cyclone** key again to turn it off.

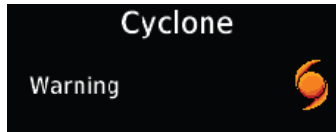

**Figure 12-26 Cyclone Legend**

## 12.1.14 Lightning

Lightning data shows the approximate location of cloud-to-ground lightning strikes. A yellow cross icon represents a strike that has occurred within a 2-kilometer (approx. 1 NM) region. The exact location of the lightning is not displayed.

Foreword

Getting Started

Audio & Xpdr Ctrl

Com/Nav

FPL

Direct-To

Proc

Charts

Wpt Info

Map

Traffic

Terrain

Weather

Nearest

Music

Utilities

System

Messages

Symbols

Appendix

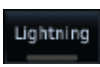

1. While viewing the Data Link Weather menu, touch the **Lightning** key.



Figure 12-27 Lightning



2. Touch the **Lightning** key again to turn it off.

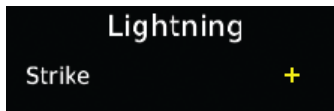

Figure 12-28 Lightning Legend

## 12.1.15 Weather Forecast

The Weather Forecast data provides Surface Analysis and City Forecast information for current and forecast weather conditions. The Surface Analysis forecast shows frontal lines indicating weather fronts and the direction they are moving. High and Low pressure centers are noted with a large H or L. A Cold Front is a front where cold air replaces warm air. A blue line with blue triangles will point in the direction of cold air flow. A Warm Front is where warm air replaces cold air. A red line with red half moons will point in the direction of the warm air flow.



1. While viewing the Data Link Weather menu, touch the **WX Forecast** key. Touch a Wx Forecast symbol for more detail.



Figure 12-29 Surface

2. Touch the desired time increment for the forecast period.



Figure 12-30 Select Surface Forecast Time Period



City Forecast

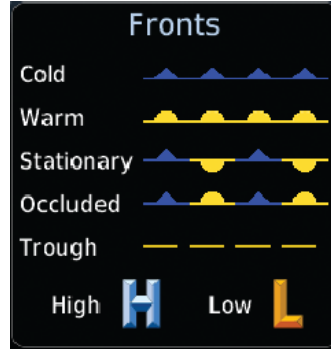

Fronts

Figure 12-31 Surface Legends

Foreword

Getting Started

Audio & Xpdr Ctrl

Com/Nav

FPL

Direct-To

Proc

Charts

Wpt Info

Map

Traffic

Terrain

**Weather**

Nearest

Music

Utilities

System

Messages

Symbols

Appendix

## 12.1.16 Winds Aloft

Winds Aloft data shows the forecast wind speed and direction at the surface and at selected altitudes. Altitudes can be selected in 3000 foot increments from the surface up to 45,000 feet.



1. While viewing the Data Link Weather menu, touch the **Winds Aloft** key.



Wind Symbols

Selected Wind Altitude

Touch To Select Wind Altitude

Figure 12-32 Winds Aloft



2. Touch the **WX Aloft ALT** **-** or **+** keys to increase or decrease the reporting altitude of the winds aloft in 3,000 foot increments. The selected altitude is shown in a window about the altitude keys.



3. Touch the **Winds Aloft** key again to turn it off.

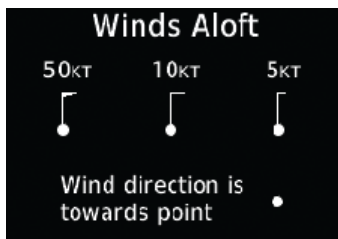

Figure 12-33 Winds Aloft Legend

## 12.1.17 Icing

The Icing product shows a graphic view of the current icing environment in four categories: light, moderate, severe, and extreme (not specific to aircraft type). The Icing product is not a forecast, but a presentation of the current conditions at the time of the analysis. Supercooled Large Droplet (SLD) icing conditions are characterized by the presence of relatively large, super cooled water droplets indicative of freezing drizzle and freezing rain aloft. SLD threat areas are depicted as black and red blocks over the Icing colors. Icing and SLD data are shown between 1,000 feet and 30,000 feet in 3,000 foot increments.

1. While viewing the Data Link Weather menu, touch the **Icing** key.

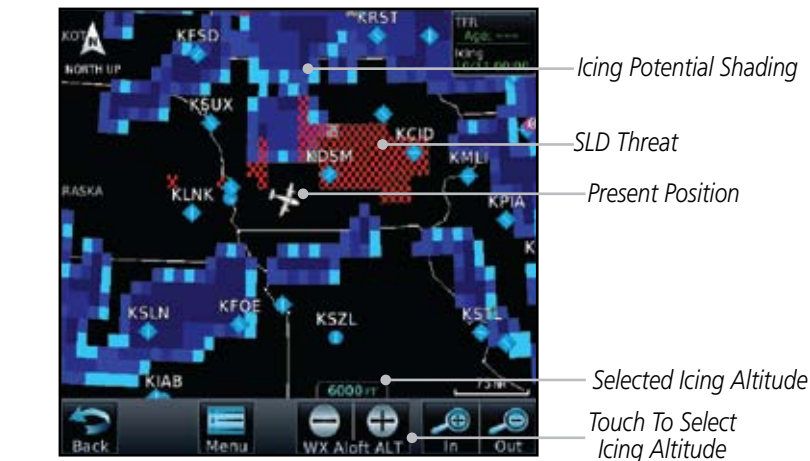

Figure 12-34 Icing and SLD

2. Touch the **WX Aloft ALT** **-** or **+** keys to increase or decrease the reporting altitude of icing in 3,000 foot increments. The selected altitude is shown in a window about the altitude keys.
3. Touch the **Icing** key again to turn it off.



Figure 12-35 Icing Legend

## 12.1.18 Turbulence

Turbulence data identifies the potential for erratic movement of high-altitude air mass associated winds. Turbulence is classified as light, moderate, severe or extreme, at altitudes between 21,000 and 45,000 feet. Turbulence data is intended to supplement AIRMETs and SIGMETs.

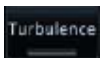

1. While viewing the Weather Data Link menu, touch the **Turbulence** key.



Turbulence Shading

Selected Turbulence Altitude

Figure 12-36 Turbulence



2. Touch the **WX Aloft ALT** **−** or **+** keys to increase or decrease the reporting altitude for turbulence in 3,000 foot increments. The selected altitude is shown in a window about the altitude keys.

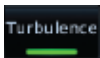

3. Touch the **Turbulence** key again to turn it off.

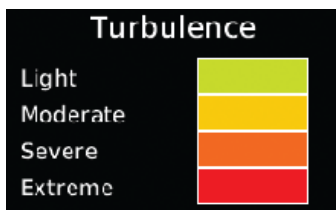

Figure 12-37 Turbulence Legend



## 12.1.19 AIREP/PIREP

Pilot Weather Reports (PIREPs) provide timely weather information for a particular route of flight. When significant weather conditions are reported or forecast, Air Traffic Control (ATC) facilities are required to solicit PIREPs. A PIREP may contain non-forecast adverse weather conditions, such as low in-flight visibility, icing conditions, wind shear, and turbulence. PIREPs are issued as either Routine (UA) or Urgent (UUA).



1. While viewing the Data Link Weather menu, touch the **AIREP/PIREP** key.



Figure 12-38 Weather Display With AIREP/PIREP Information Active

2. Touch a weather information symbol to view details for that item.



Figure 12-39 AIREP/PIREP Information Detail

Foreword  
Getting Started  
Audio & Xpdr Ctrl  
Com/Nav  
FPL  
Direct-To  
Proc  
Charts  
Wpt Info  
Map  
Traffic  
Terrain  
Weather  
Nearest  
Music  
Utilities  
System  
Messages  
Symbols  
Appendix  
Index



3. Touch the **Back** key to remove the detailed information.



4. Touch the **AIREP/PIREP** key again to turn it off.

## 12.2 StormScope® Weather



### 12.2.1 StormScope® (Optional)



**NOTE:** Refer to the *WX-500 Pilot's Guide* for a detailed description of the *WX-500 StormScope*.

The WX-500 StormScope Weather Mapping Sensor is a passive weather avoidance system that detects electrical discharges associated with thunderstorms within a 200-NM radius of the aircraft. The StormScope measures relative bearing and distance of thunderstorm-related electrical activity and reports the information to the display. **Interfaces are currently only available for the WX-500 StormScope System.**

For lightning display interpretation, study the examples in the WX-500 Pilot's Guide that are designed to help you relate the cell or strike patterns shown on the display to the size and location of thunderstorms that may be near your aircraft.

1. From the Home page, touch the **Weather** key (and then the **StormScope** key if present) to reach the StormScope function.



Touch To Clear Lightning Strikes

Range Ring

Lightning Strikes

Lightning Display Mode (Cell or Strike)

Lightning Strike Rate

**Figure 12-40 StormScope Display (360° Display View Shown)**



2. Touch the **Menu** key to setup the StormScope display.



Figure 12-41 StormScope Menu

3. Touch the **360°** or **Arc** to select the display view.

## 12.2.2 Clearing the StormScope® Page

Routinely clearing the StormScope Page of all discharge points is a good way to determine if a storm is building or dissipating. In a building storm discharge points reappear faster and in larger numbers. In a dissipating storm discharge points appear slower and in smaller numbers.



1. While viewing the Weather StormScope page, touch the **Clear Strikes** key to clear lightning strikes.
2. Lightning strikes will be cleared from the display and the Rate value will be reset.

## 12.2.3 Changing the StormScope® Display View

The Lightning Page displays either a 360° or a 120° viewing angle.

1. While viewing the Weather StormScope page, touch **MENU**.
2. Touch the **360°** or **Arc** to select the display view.



Figure 12-42 StormScope 360° and Arc Display Views

## 12.2.4 Changing the Storm Data Display Range

Storm data can be displayed on the Map page 2000 NM zoom scale, but the data only goes out as far as the StormScope can report (200 NM). The 500 NM zoom scale will display all lightning data. Scales greater than 500 NM do not display any additional StormScope data.

1. While viewing the StormScope page touch the **In** and **Out** keys to display a larger or smaller area.



**NOTE:** Cell mode uses a clustering program to identify clusters of electrical activity that indicate cells. Cell mode is most useful during periods of heavy storm activity. Displaying cell data during these periods frees the user from sifting through a screen full of discharge points and helps to better determine where the storm cells are located.

## 12.2.5 Displaying StormScope® Data on the Map Page

The Map Page displays cell or strike information using yellow lightning strike symbology overlaid on a moving map. This added capability improves situational awareness, which in turn makes it much easier for the pilot to relate storm activity to airports, NAVAIDs, obstacles and other ground references.



**NOTE:** *StormScope data is displayed on the Map Page only if aircraft heading is available.*



1. On the Home page, touch the **Map** key.



2. Touch the **Menu** key.



3. Touch the **StormScope** key to enable StormScope lightning display on the Map page. Repeated touches toggle between Off, Cell, and Strike.



Foreword

Getting Started

Audio & Xpdr Ctrl

Com/Nav

FPL

Direct-To

Proc

Charts

Wpt Info

Map

*This page intentionally left blank*

Traffic

Terrain

Weather

Nearest

Music

Utilities

System

Messages

Symbols

Appendix

## 13 NEAREST



The Nearest function provides detailed information for the 25 nearest airports, VORs, NDBs, Intersections and User waypoints within 200 NM of your current position. In addition, the Nearest pages include the five nearest Flight Service Station (FSS) and center (ARTCC/FIR) points of communication and alert you to any Special Use (SUA) or Controlled Airspace you may be in or near.



Figure 13-1 Nearest Page



Figure 13-2 Nearest Page Functional Map

## 13.1 Select a Nearest Page

The available waypoint types are shown on the Nearest page. Touch the key to display the nearest 25 waypoint types (FSS and ARTCC will display up to five items). Not all 25 nearest waypoints can be displayed on the corresponding Nearest page at one time. The Nearest page displays detailed information for five nearest items.



1. On the Home page, touch the **Nearest** key.



2. Touch the desired waypoint type (Airport, VOR, etc.) and then touch the **Up** and **Down** keys on the lower right of the display to navigate through the list of available items. You can also touch an item on the list and drag your finger to scroll the list.

3. Touch the highlighted item to view more detailed information.



4. To navigate Direct-To the waypoint you're viewing, press the **Direct-To** key. The waypoint will be loaded into the Waypoint window of the Direct-To function.



5. Touch the **Activate** key to navigate directly to that waypoint.

## 13.2 Nearest Airport

The Nearest Airport Page displays the identifier, symbol, bearing and distance, and the length of the longest runway for the 25 nearest airports (within 200 NM of your present position).

The Nearest Airport Page can be configured to exclude shorter runways or undesirable runway surface types, so that the corresponding airports do not appear on the list. You may wish to use this feature to exclude seaplane bases, heliports, or runway lengths which would be difficult or impossible to land upon. See *System - Setup - Nearest Airport Criteria* for information about configuring the Nearest Airport display criteria.





1. While viewing the Nearest function, touch the **Airport** key. A list of the nearest 25 airports within 200 NM will be listed.

Airport Identifier



Scroll Bar Indicate More Items On The List

Airport Information

Figure 13-3 Nearest Airport



2. Touch the **Up** and **Down** keys to scroll through the list.



3. Touch the **Airport Identifier** key to show the Waypoint Info page for the selected airport.



Distance & Bearing Information Referenced To Current Position

Airport Information Page

Touch To View Charts When Available

Figure 13-4 Nearest Airport Waypoint Info

4. Touch one of the tabs (Map, Procedures, Runways, etc.) on the sides of the display for more information about the selected airport.

### 13.3 Nearest Intersection (INT)

The Nearest Intersection Page displays the identifier, symbol, bearing and distance to the 25 nearest intersections (within 200 NM of your present position).



1. While viewing the Nearest function, touch the **INT** key. A list of the nearest 25 Intersections within 200 NM will be listed.



Slider Indicates More Items On The List

Intersection Identifier

Intersection Information

Arrow Indicates More Items On The List

Figure 13-5 Nearest Intersection List



2. Touch the **Up** and **Down** keys to scroll through the list.



Slider Indicates More Items On The List

Arrows Indicate More Items On The List

Figure 13-6 Scrolling Down the Nearest Intersection List

Foreword  
Getting Started  
Audio & Xpdr Ctrl  
Com/Nav  
FPL  
Direct-To  
Proc  
Charts  
Wpt Info  
Map  
Traffic  
Terrain  
Weather  
Nearest  
Music  
Utilities  
System  
Messages  
Symbols  
Appendix

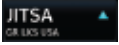

3. Touch the **Intersection Identifier** key to show the Waypoint Info page for the selected Intersection.



*Distance & Bearing Information Referenced To Current Position*

*Intersection Map Detail*

*Map Range Keys*

**Figure 13-7 Nearest Intersection Waypoint Detail**

Foreword

Getting Started

Audio & Xpdr Ctrl

Com/Nav

FPL

Direct-To

Proc

Charts

Wpt Info

Map

Traffic

Terrain

Weather

**Nearest**

Music

Utilities

System

Messages

Symbols

Appendix

## 13.4 Nearest VOR

The Nearest VOR Page displays the identifier, symbol, bearing and distance to the 25 nearest VORs (within 200 NM of your present position). For each VOR listed, the Nearest VOR Page also indicates the frequency and may be used to quickly tune the Nav radio to the nearby VOR (GTN 750 only).

Touch the VOR Frequency key to place the frequency in the standby field of the Nav window. Touch the **Nav** Active window to flip/flop the Nav frequencies.

1. While viewing the Nearest function, touch the **VOR** key. A list of the nearest 25 VORs within 200 NM will be listed.



Figure 13-8 Nearest VOR List and Information

2. Touch the **Up** and **Down** keys to scroll through the list.



MCI  
Kansas City

3. Touch the **VOR Identifier** key to show the Waypoint Info page for the selected VOR.



VOR Information  
Referenced To Current  
Position

Additional VOR Information

VOR Map Detail

VOR Location

Figure 13-9 Nearest VOR Waypoint Information

Frequency  
113.25

4. Touch the **Frequency** key on this page or from the Nearest VOR List page to place the selected frequency into the Nav Standby window.



Touch to Flip/Flop

VOR Frequency Inserted  
Into Standby Window.

VOR Frequency

Figure 13-10 Nearest VOR Frequency Entry

Foreword

Getting Started

Audio & Xpdr Ctrl

Com/Nav

FPL

Direct-To

Proc

Charts

Wpt Info

Map

Traffic

Terrain

Weather

Nearest

Music

Utilities

System

Messages

Symbols

Appendix

## 13.5 Nearest NDB

The Nearest NDB Page displays the identifier, symbol, bearing, distance and frequency to the 25 nearest NDBs (within 200 NM of your present position).

1. While viewing the Nearest function, touch the **NDB** key. A list of the nearest 25 NDBs within 200 NM will be listed.



NDB	Bearing	Distance	Frequency
<b>DKB</b> Dekalb	191°	0.5 NM	209.0
<b>RF</b> Gilmy	303°	20.4 NM	275.0
<b>ME</b> Deana	090°	30.4 NM	350.0 WX
<b>OIX</b> Ditowa	194°	35.4 NM	266.0
<b>HK</b> Erwin	111°	41.2 NM	332.0

Scroll Bar Indicates More Items On The List. Touch And Drag Finger To Scroll.

NDB Identifier

NDB Information

Arrows Indicate More Items On The List

Figure 13-11 Nearest NDB



2. Touch the **Up** and **Down** keys to scroll through the list.

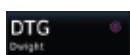

3. Touch the **NDB Identifier** key to show the Waypoint Info page for the selected NDB.

Waypoint Info - NDB

**RF**  
Gilmy

DIS: 19.4 NM    N 42°06.86'

BRG: 298°    W089°05.92'

Location: Rockford, IL  
GR LKS USA

Frequency: 275.0    Nearest Airport: KRFD  
4.9 NM    003°

Marker Description: Compass Locator

NDB Map Detail

Map Range Keys

Distance and Bearing Referenced To Current Position

NDB Map Detail

Map Range Keys

Figure 13-12 Nearest NDB Waypoint Information

## 13.6 Nearest User Waypoint

The Nearest User Waypoint Page displays the name, bearing and distance to the 25 nearest user waypoints (within 200 NM of your present position).



1. While viewing the Nearest function, touch the **User Waypoint** key. A list of the nearest 25 User waypoints within 200 NM will be listed.



Figure 13-13 Nearest User Waypoint



2. Touch the **Up** and **Down** keys to scroll through the list.

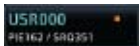

3. Touch the **User Identifier** key to show the Waypoint Info page for the selected User waypoint.



User Wpt Distance & Bearing Referenced To Current Position

User Wpt Map Detail

Map Range Keys

Figure 13-14 Nearest User Waypoint Information

## 13.7 Nearest Airspace

The Nearest Airspace Page, alerts you to as many as 25 controlled or special use airspaces near or in your flight path. Alerts are provided according to the following conditions:

- If your projected course will take you inside an airspace within the next ten minutes, the alert message “*AIRSPACE ALERT - Airspace entry in less than 10 minutes*” appears. The Nearest Airspace Page shows the airspace as “Airspace Ahead.”
- If you are within two nautical miles of an airspace and your current course will take you inside, the message “*AIRSPACE ALERT - Within 2nm of airspace*” appears. The Nearest Airspace Page shows the airspace as “Airspace Within 2 NM.”
- If you are within two nautical miles of an airspace and your current course will take you inside in less than 10 minutes, the message “*AIRSPACE ALERT - Airspace within 2nm and entry in less than 10 minutes*” appears. The Nearest Airspace Page shows the airspace as “Ahead < 2 NM.”
- If you have entered an airspace, the message “*AIRSPACE ALERT - Inside Airspace*” appears. The Nearest Airspace Page shows “Inside of airspace.”

Note that the airspace alerts are based on three-dimensional data (latitude, longitude and altitude) to avoid nuisance alerts. The alert boundaries for controlled airspace are also sectorized to provide complete information on any nearby airspace. Once one of the described conditions exists, the message annunciator flashes, alerting you of an airspace message (if airspace alert messages are enabled). See *System-Alerts* to set the Arrival Alert Proximity, Airspace Type, and Altitude Buffer values.

- Foreword
- Getting Started
- Audio & Xpdr Ctrl
- Com/Nav
- FPL
- Direct-To
- Proc
- Charts
- Wpt Info
- Map
- Traffic
- Terrain
- Weather
- Nearest**
- Music
- Utilities
- System
- Messages
- Symbols
- Appendix





**Figure 13-15 Airspace Sectors**

1. While viewing the Nearest function, touch the **Airspace** key. A list of the nearest 25 Airspaces within 200 NM along the aircraft flight path will be listed, depending on the airspace types and values set by the user.



**Figure 13-16 Nearest Airspace List**



2. Touch the **Up** and **Down** keys to scroll through the list.



3. Touch the **Airspace Identifier** key to show the Waypoint Info page for the selected Airspace.

Foreword  
 Getting Started  
 Audio & Xpdr Ctrl  
 Com/Nav  
 FPL  
 Direct-To  
 Proc  
 Charts  
 Wpt Info  
 Map  
 Traffic  
 Terrain  
 Weather  
**Nearest**  
 Music  
 Utilities  
 System  
 Messages  
 Symbols  
 Appendix



**Figure 13-17 Nearest Airspace Waypoint Information**

Once you have been provided an airspace alert message, detailed information concerning the specific airspace is provided on the Nearest Airspace Page. The Nearest Airspace Page displays the airspace name, status (“AIRSPACE ALERT - inside Airspace”, “AIRSPACE ALERT - Airspace entry in less than 10 minutes”, etc.), and a time to entry (if applicable). By selecting any airspace name listed on the Nearest Airspace Page, additional details are provided — including controlling agency, communication frequencies and floor/ceiling limits.

## 13.8 Nearest ARTCC

The Nearest ARTCC page displays the facility name, bearing to, distance, and frequency to the five nearest Air Route Traffic Control Center (ARTCC) points of communication (within 200 NM of your present position). For each ARTCC listed, the Nearest ARTCC page also indicates the frequency(s) and may be used to quickly tune the COM transceiver to the center's frequency.

Touch the ARTCC Frequency key to place the frequency in the standby field of the COM window. Touch the **COM** Active window to flip/flop the Com frequencies (GTN 750 only).



1. While viewing the Nearest function, touch the **ARTCC** key. A list of the nearest five ARTCCs within 200 NM will be listed.

ARTCC	Bearing	Distance	Frequency
Miami	041°	19.0 NM	Multiple FREQ
Miami	022°	70.6 NM	Multiple FREQ
Miami	002°	74.5 NM	132.45
Miami	232°	85.0 NM	Multiple FREQ
Miami	317°	94.9 NM	Multiple FREQ

ARTCC Name and Information

ARTCC Frequency Key With Multiple Frequencies Available

ARTCC Frequency Key

Figure 13-18 Nearest ARTCC



2. Touch the **Up** and **Down** keys to scroll through the list as needed.

Foreword  
Getting Started  
Audio & Xpdr Ctrl  
Com/Nav  
FPL  
Direct-To  
Proc  
Charts  
Wpt Info  
Map  
Traffic  
Terrain  
Weather  
Nearest  
Music  
Utilities  
System  
Messages  
Symbols  
Appendix

**Multiple  
FREQ**

- The Frequency category will show "Multiple" keys if multiple frequencies are available. Touch the **Multiple FREQ** key to display the frequencies.



*Selected ARTCC Frequency Key*

*ARTCC Multiple Frequency Key*

*ARTCC Multiple Frequency List*

**Figure 13-19 Nearest ARTCC Multiple Frequency List**

**135.17**

- Touch the key for the desired frequency to place the selected frequency into the Com Standby window.

*Touch To Flip/Flop Active And Standby Frequencies*

*Selected ARTCC Frequency Inserted Into Standby Window*

*Selected ARTCC Multiple Frequency List Key*



**Figure 13-20 Selected ARTCC Frequency From List**

## 13.9 Nearest Flight Service Station (FSS)

The Nearest Flight Service Station (FSS) Page displays the facility name, bearing to, distance, and frequency to the five nearest FSS points of communication (within 200 NM of your present position). For each FSS listed, the Nearest FSS Page also indicates the frequency(s) and may be used to quickly tune the COM transceiver to the FSS's frequency.

Touch the FSS Frequency key to place the frequency in the standby field of the COM window. Touch the **COM** Active window to flip/flop the Com frequencies (GTN 750 only). Receive-only frequencies are noted with a white "RX."



1. While viewing the Nearest function, touch the **FSS** key. A list of the nearest five FSSs within 200 NM will be listed.



Figure 13-21 Nearest FSS



2. Touch the **Up** and **Down** keys to scroll through the list, if necessary.

Multiple  
FREQ

- The **Frequency** key will show "Multiple FREQ" if multiple frequencies are available. Touch the **Multiple FREQ** key to display the frequencies.



Slider Indicates More Frequencies. Touch And Drag Finger To View More.

FSS Multiple Frequency List

Touch The Up And Down Keys To View More Frequencies

**Figure 13-22 Nearest FSS Multiple Frequency List**

122.20

- Touch the key for the desired frequency to place the selected frequency into the Com Standby window.

Selected FSS Frequency Inserted Into Standby Window



FSS Multiple Frequency Key

**Figure 13-23 Selected FSS Frequency From List**

## 13.10 Nearest Weather Frequency (WX Freq)

The Nearest WX FREQ function displays facility name, bearing to, distance, and frequency for the nearest 25 Automatic Terminal Information Service (ATIS), Automated Service Observing System (ASOS), and Automated Weather Observing Station (AWOS) weather reporting stations within 200 NM.



1. While viewing the Nearest function, touch the **WX FREQ** key. A list of the nearest 25 Weather stations within 200 NM will be listed.



Figure 13-24 Nearest Weather Station



2. Touch the **Up** and **Down** keys to scroll through the list, as needed.

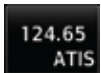

3. Touch the key for the desired frequency to place the selected frequency into the Com Standby window.

Foreword  
Getting Started  
Audio & Xpdr Ctrl  
Com/Nav  
FPL  
Direct-To  
Proc  
Charts  
Wpt Info  
Map  
Traffic  
Terrain  
Weather  
Nearest  
Music  
Utilities  
System  
Messages  
Symbols  
Appendix

*Selected Weather Frequency Inserted Into Standby Window*



*Selected Weather Frequency Key*

**Figure 13-25 Nearest Weather Station Selected Frequency**

4. Touch the **Weather Station Identifier** key to show the Waypoint Info page for the selected Weather station.



*Wpt Identifier, Type, and Name*



*Dis & Brg Information Referenced To Current Position*

*Weather Tab Selected*

*Wpt Information Detail*

**Figure 13-26 Nearest Weather Station Waypoint Information**





**NOTE:** Refer to the Weather Section for information about XM Weather products.

The optional XM® Radio entertainment feature of the GDL 69A Data Link Receiver is available for the pilot's and passengers' enjoyment. The GDL 69A can receive XM Satellite Radio entertainment services at any altitude throughout the Continental U.S. Entertainment audio is not available on the GDL 69 Data Link Receiver.

XM Satellite Radio offers a variety of radio programming over long distances without having to constantly search for new stations. Based on signals from satellites, coverage far exceeds land-based transmissions. XM Satellite Radio services are subscription-based. For more information on specific service packages, visit [www.xmradio.com](http://www.xmradio.com).

Audio entertainment is available through the XM Satellite Radio Service when activated in the optional installation of the GDL 69A. The GTN unit serves as the display and control head for your remotely mounted GDL 69A. When enabled, the XM Satellite Radio audio entertainment is accessible in the Music function.

The information on the XM Satellite Radio display is composed of four areas: the Active Channel, Available Channels, Category of the highlighted channel, and the Volume setting. The Active Channel window shows the Channel Name and Number, Artist, Song Title, and Category.

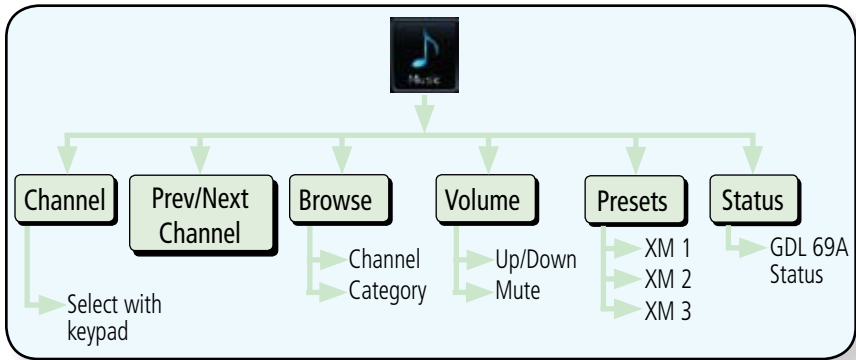

Figure 14-1 Music Functional Diagram

## 14.1 Activating XM<sup>®</sup> Satellite Radio Services

The service is activated by providing XM Satellite Radio with either one or two coded IDs, depending on the equipment. Either the Audio Radio ID or the Data Radio ID, or both, must be provided to XM Satellite Radio to activate the entertainment subscription. The XM Satellite Radio Activation Instructions are included with the GDL 69A (also available at [www.garmin.com](http://www.garmin.com), P/N 190-00355-04).

It is not required to activate both the entertainment and weather service subscriptions with the GDL 69A. Either or both services can be activated. XM Satellite Radio uses one or both of the coded IDs to send an activation signal that, when received by the GDL 69A, allows it to play entertainment programming.

These IDs are located:

- On the label on the back of the Data Link Receiver
- On the Music Menu

Contact the installer if the Data Radio ID and the Audio Radio ID cannot be located.



---

**NOTE:** Refer to the *GDL 69/69A XM Satellite Radio Activation Instructions (190-00355-04)* for further information.

---

1. Contact XM WX Satellite Radio through the e-mail address listed on their web site ([www.xmradio.com](http://www.xmradio.com)) or by the customer service phone number listed on the web site (1-800-985-9200).
2. Follow the instructions provided by XM Satellite Radio services.

If XM weather services have not been activated, all the weather product boxes are cleared on the XM Information Page and a yellow Activation Required message is displayed in the center of the Weather Data Link Page (Map Page Group). The Service Class refers to the groupings of weather products available for subscription.

## 14.2 Music Operation

The GTN 7xx provides control for enjoying XM Radio audio entertainment in the aircraft. The Music function allows selecting music categories and specific channels, as well as saving category and channel selections as presets for quick recall. The music volume level may also be managed.

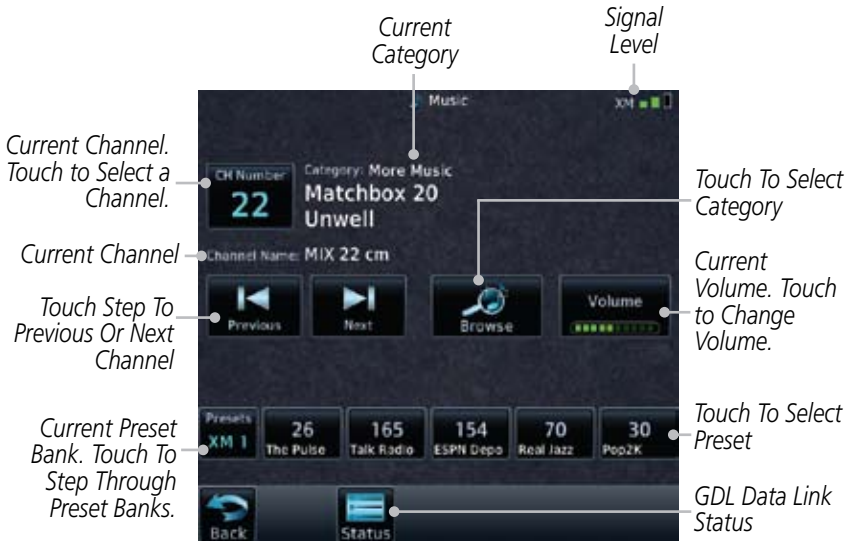

Figure 14-2 Main Music Display



**NOTE:** The Music Configuration function can be set so that when there is radio reception or intercom conversation, the music level is dropped to a low, or background level. When the radio or intercom traffic ceases, the level gradually returns to normal.

## 14.2.1 Browsing Channels and Categories

The Category window displays the currently selected category of audio. Categories of channels, such as Jazz, Rock, or News, can be selected to list the available channels for a type of music or other contents.



1. While viewing the Music page, touch the **Browse** key and then touch the desired channel to select it.



Figure 14-3 Music Channels



2. Touch the **Category** key to activate Category selection and then touch the desired **Category** to select it.



Figure 14-4 Music Categories

3. The current category will be shown at the top of the display.

## 14.2.2 Selecting an XM® Radio Channel by Number

Channels may be selected directly in the selected category using the numeric keypad.



1. While viewing the main Music page, touch the **Channel** key. The Channel Number selection page will appear.



Figure 14-5 Selecting Music Channels



2. Use the numeric keys to enter the number for the desired channel and then touch the **Enter** key.

Channel Number Window



Touch to Clear Channel Number Window

Numeric Keypad for in Channel Number Selection

Touch to Select Channel Shown in Channel Number Window

Figure 14-6 Selecting Music Channels with the Numeric Keypad

## 14.2.3 XM® Radio Volume

The Volume control allows you to set the audio volume level, as well as mute the audio.

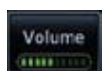

1. While viewing the Music page, touch the **Volume** key.

*Bar Graph Showing Volume Level*



**Figure 14-7 Music Volume Control**



2. Touch the **Up** or **Down** Volume keys to adjust the radio volume.



3. Touch **MUTE** to toggle muting of the radio volume.



4. Touch **MUTE** again or the **Volume** key to unmute the radio volume.



## 14.2.4 XM® Radio Channel Presets

The Music Menu allows you to store the Active Channel into a selected preset position for easy later recall. A delay of several seconds can occur when setting or recalling a preset.



Figure 14-8 Music Presets

### 14.2.4.1 Saving a Preset



1. While viewing the desired channel, select the preset bank for saving the preset (XM 1, XM 2, or XM 3) by touching the **Presets** key until the desired bank is shown.
2. Touch the desired Preset key and hold it for three seconds.



### 14.2.4.2 Recalling a Preset



1. Touch the **Presets** key to select the preset bank (XM 1, XM 2, or XM 3).
2. Touch the desired Preset key.



## 14.3 GDL 69/69A Data Link Receiver Troubleshooting

Some quick troubleshooting steps listed below can be performed to find the possible cause of a failure.

- Ensure the owner/operator of the aircraft in which the Data Link Receiver is installed has subscribed to XM
- Ensure the XM subscription has been activated
- Perform a quick check of the circuit breakers to ensure that power is applied to the Data Link Receiver

For troubleshooting purposes, check the Menu on the Music Page or the GDL 69 Box on the System - External LRUs Page for Data Link Receiver (GDL 69/69A) status, serial number, and software version number.

It may take several minutes for all subscribed data to become available after power-up.

Text Color	Description
White	Subscribed
Grey	Not Subscribed
Green	Available

Table 14-1 Product Status

1. Touch the **Status** key on the Music page to display the GDL 69/69A Status.



Data Radio ID & Signal Level

Subscription Level



Audio Radio ID & Signal Level

GDL 69A SW Version and Serial Number

Weather Product List

Weather Product Legend

Music Menu

Figure 14-9 GDL 69 Status Page



- The GDL status information is provided on this page.
- Touch the **Menu** key to display the GDL Status Menu.



Figure 14-10 GDL Status Menu

- Touch the **Lock Activation** key if this is for the initial subscription or a change in the subscription. Touch the **OK** key to continue the operation.

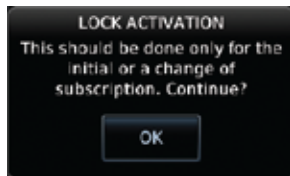
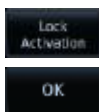

Figure 14-11 Lock Activation

Foreword

Getting  
Started

Audio &  
Xpdr Ctrl

Com/Nav

FPL

Direct-To

Proc

Charts

Wpt Info

Map

*This page intentionally left blank*

Traffic

Terrain

Weather

Nearest

Music

Utilities

System

Messages

Symbols

Appendix

## 15 UTILITIES



The Utilities page provides a group of features that will support your flight planning to make them easier and more efficient. The Vertical Calculator (VCALC) calculates the time to begin descent and vertical speed required to reach a desired altitude at the chosen location. The Flight Timers feature provides a number of timer types to assist in monitoring your time in flight. RAIM Prediction predicts if GPS coverage is available for your current location or at a specified waypoint at any time and date. RAIM performs checks to ensure that the GTN unit has adequate satellite geometry during your flight. The Trip Planning feature allows the pilot to view desired track (DTK), distance (DIS), estimated time en route (ETE), en route safe altitude (ESA) and estimated time of arrival (ETA) information for a direct-to, point-to-point between two specified waypoints or for any programmed flight plan. The Fuel Planning feature will display fuel conditions along the active direct-to or flight plan when equipped with fuel flow (FF) and/or fuel on board (FOB) sensors. The DALT/TAS/Winds feature performs calculations about Altitude, Airspeed, and Winds. The Clean Screen function will lock the touchscreen so the display can be cleaned without activating any functions.



Figure 15-1 Utilities Home Page

Foreword  
 Getting Started  
 Audio & Xpdr Ctrl  
 Com/Nav  
 FPL  
 Direct-To  
 Proc  
 Charts  
 Wpt Info  
 Map  
 Traffic  
 Terrain  
 Weather  
 Nearest  
 Music  
**Utilities**  
 System  
 Messages  
 Symbols  
 Appendix

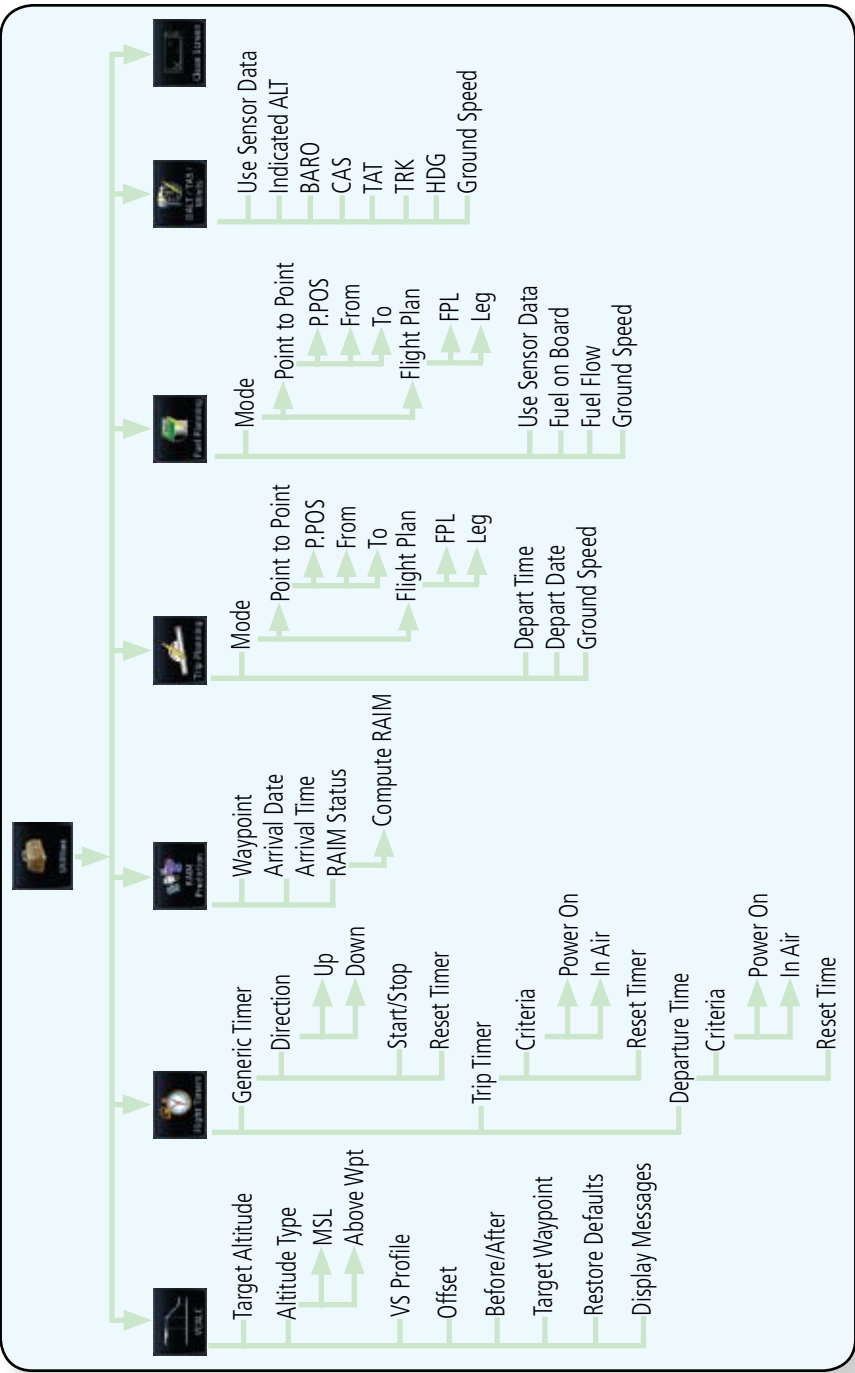

Figure 15-2 Utilities Functional Diagram

## 15.1 Vertical Calculator (VCALC)



The Vertical Calculator (VCALC) function allows you to create a three-dimensional profile which guides you from your present position and altitude to a final (target) altitude at a specified location. This is helpful when you'd like to descend to a certain altitude near an airport. Once the profile is defined, message alerts and additional data can be configured on the Default NAV and Map Pages to keep you informed of your progress.

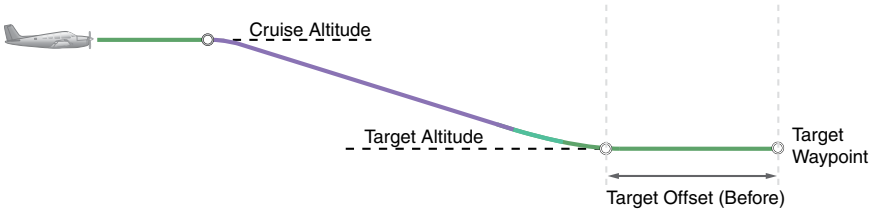

Figure 15-3 VCALC Target

VCALC is inhibited in the following conditions:

- Groundspeed is less than 35 knots
- No active flight plan or direct-to destination
- SUSP mode
- Vectors-to-Final mode
- VLOC mode
- After the FAF on an approach



**WARNING:** Do not use VCALC messages as the only means of either avoiding terrain/obstacles or following ATC guidance. VCALC provides advisory information only and must be used in concert with all other available navigation data sources.

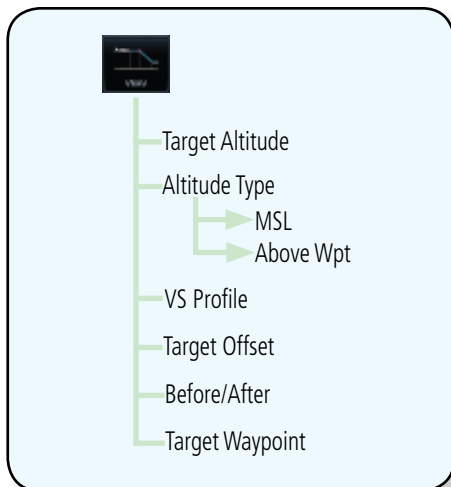

Figure 15-4 VCALC Page Functional Diagram

1. From the Utilities page, touch **VCALC**.

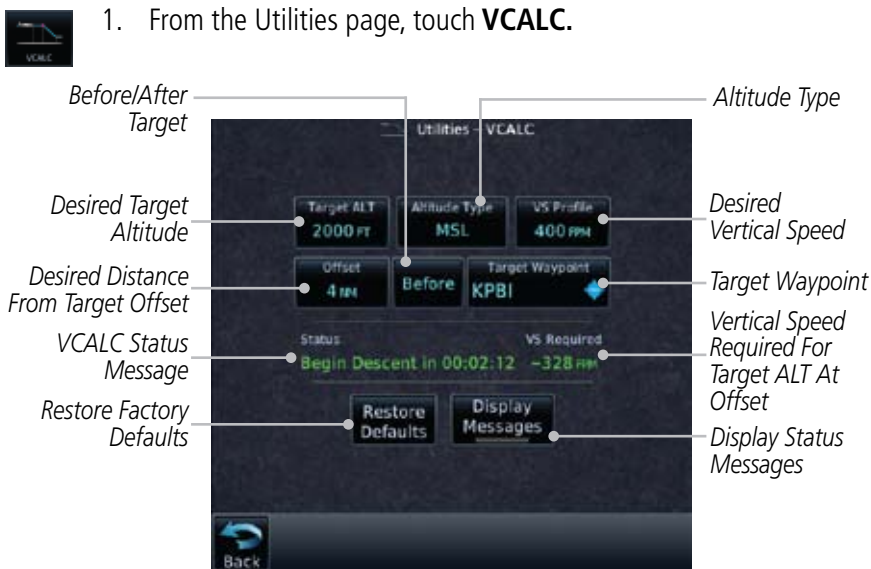

Figure 15-5 VCALC Page

2. Select the VCALC items as necessary to set up parameters for the next waypoint. Touch the **Back** key when finished.

## 15.1.1 Target Altitude

This sets the desired ending altitude for the VCALC setup.



1. While viewing the VCALC page, touch **Target ALT**.

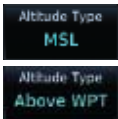

Figure 15-6 Select VCALC Target Altitude

2. Use the numeric keypad to select the desired Target Altitude and then touch the **Enter** key.

## 15.1.2 Altitude Type

This value selects the altitude reference that will be used for VCALC calculations.



1. While viewing the VCALC page, touch **Altitude Type**.
2. Touching the **Altitude Type** key will toggle between MSL and Above WPT. "Above WPT" is only available for waypoints that are airports.

### 15.1.3 Vertical Speed (VS) Profile

This value sets the desired vertical speed.



1. While viewing the VCALC page, touch **VS Profile**.



**Figure 15-7 Select VCALC Vertical Speed**

2. Use the numeric keypad to select the desired Vertical Speed and then touch the **Enter** key.



- Foreword
- Getting Started
- Audio & Xpdr Ctrl
- Com/Nav
- FPL
- Direct-To
- Proc
- Charts
- Wpt Info
- Map
- Traffic
- Terrain
- Weather
- Nearest
- Music
- Utilities**
- System
- Messages
- Symbols
- Appendix
- Index



## 15.1.4 Target Offset

The Target Offset is a pilot-selected distance value that represents the geographical location where you wish to arrive at the target altitude. This distance is measured from the Target Waypoint and, in a separate data field on the VCALC page, designated as either before or after the Target Waypoint.



1. While viewing the VCALC page, touch the **Offset** key.



Figure 15-8 Select VCALC Target Offset



2. Use the numeric keypad to select the desired Target Offset and then touch the **Enter** key.

## 15.1.5 Before/After Target Waypoint

This setting designates whether the offset distance defines a point before you reach the target reference waypoint or after you reach the waypoint. The “After” selection is not available for the last waypoint in a flight plan.

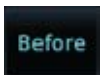

1. While viewing the VCALC page, touch the **Before/After** key.

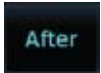

2. Touching the **Before/After** key will toggle between Before and After the Target Waypoint.

## 15.1.6 Target Waypoint

Select the waypoint in the flight plan that will be used for planning a descent. When using a flight plan, the target waypoint is a reference that can be specified from the waypoints contained in the flight plan. By default, the last waypoint in the flight plan is selected.

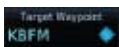

1. While viewing the VNAV page, touch **Target Waypoint**.



Figure 15-9 Select VNAV Target Waypoint List

2. A list of the remaining waypoints in the flight plan will be shown. Touch the desired waypoint to select it as the Target Waypoint.

## 15.1.7 Display VCALC Messages

Selecting **Display Messages** will allow the display of messages about the VCALC function when they occur. With **Display Messages** not selected, VCALC messages will not be displayed.



1. While viewing the VCALC page, touch **Display Messages** to toggle the display of VCALC messages in the Message function.

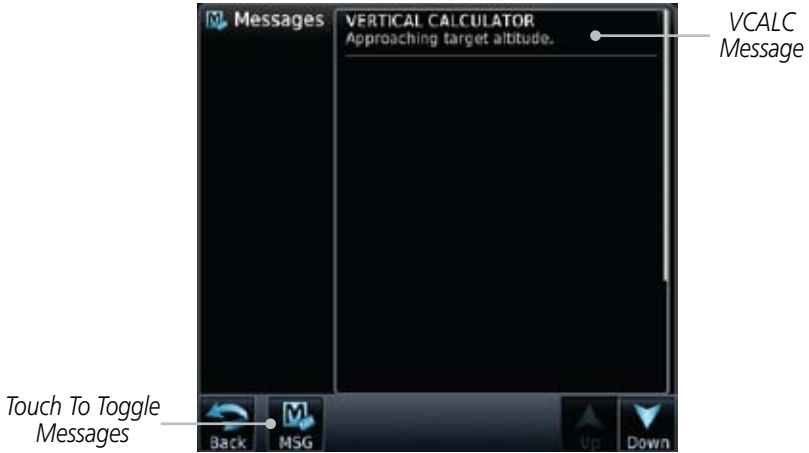

Figure 15-10 VCALC Approaching Target Altitude Message



2. Touch the **MSG** key to toggle the display of available messages.

## 15.1.8 Restore VCALC Defaults

While viewing the VCALC page menu, touching the **Restore Defaults** key will reset all of the VCALC values back to their default values. The Target Waypoint will not be changed.

## 15.2 Flight Timers



The Flight Timers function provides count up/down timers, plus automatic recording of departure time, and total trip time. Departure and total trip time recording can be configured to run either any time unit power is on, or only when your ground speed exceeds the in-air threshold set by the installer (for example, 30 knots). A flexible Generic Timer is available for general timing needs.



**NOTE:** When a count up timer is used, the preset value has no function.

1. While viewing the Utilities page, touch the **Flight Timers** key.

Start/Stop Generic Timer

Reset or Preset Timer



**Figure 15-11** Utility Flight Timers Page

2. If the Generic Timer Direction counter is set to "Up," the Reset Timer key will be shown and when touched will return the timer to 00:00:00. If the Direction counter is set to "Down," the Preset Timer key will be shown and the key will return the timer to the Preset time value.
3. Touch each key as desired to set up timer operation.

## 15.3 RAIM Prediction

RAIM Prediction predicts if GPS coverage is available for your current location or at a specified waypoint at any time and date. RAIM performs checks to ensure that the GTN unit has adequate satellite geometry during your flight. RAIM availability is near 100% in Oceanic, En Route and Terminal phases of flight. Because the FAA's TSO requirements for non-precision approaches specify significantly better satellite coverage than other flight phases, RAIM may not be available when flying some approaches. The GTN unit automatically monitors RAIM during approach operations and warns you if RAIM is not available. In such cases, use a non-GPS based approach. RAIM prediction helps you plan for a pending flight to confirm GPS operation during an approach.

RAIM prediction only predicts the availability of Fault Detection (FD) integrity in the absence of SBAS corrections. It cannot predict the availability of LPV or L/NAV approaches. The FAA provides a NOTAM service for LPV approach availability.



1. While viewing the Utilities page, touch the **RAIM Prediction** key.

*Touch To Select Destination Waypoint*



*Touch To Select Local Arrival Time*  
*Touch To Select Local Arrival Date*

**Figure 15-12 Utility RAIM Prediction Page**

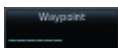

2. Touch the **Waypoint** key and select the waypoint for RAIM Prediction.



3. Touch the **Arrival Date** key and select the date of arrival at the selected waypoint.

Foreword  
Getting Started  
Audio & Xpdr Ctrl  
Com/Nav  
FPL  
Direct-To  
Proc  
Charts  
Wpt Info  
Map  
Traffic  
Terrain  
Weather  
Nearest  
Music  
Utilities  
System  
Messages  
Symbols  
Appendix  
Index

Arrival Time  
22-18 UTC

4. Touch the **Arrival Time** key and select the local time of expected arrival at the selected waypoint.
5. When the Waypoint, Arrival Date, and Arrival Time values have been entered, touch the **Compute RAIM** key to determine if RAIM is available.

Compute RAIM



Touch To  
Compute RAIM

RAIM Prediction  
Result

Figure 15-13 RAIM Prediction Completed

## 15.4 Trip Planning

The GTN 7XX allows the pilot to view desired track (DTK), distance (DIS), estimated time en route (ETE), en route safe altitude (ESA) and estimated time of arrival (ETA) information for a direct-to, point-to-point between two specified waypoints or for any programmed flight plan. This item also displays the sunrise/sunset times for your destination waypoint (for the selected departure date). All times are based on the time set in System-Setup. The trip planning inputs are manually entered by the pilot.

The trip statistics are calculated based on the selected starting and ending waypoints and the trip planning inputs.

In Flight Plan mode with a stored flight plan selected, and the entire flight plan (CUM) selected, the waypoints are the starting and ending waypoints of the selected flight plan.

In Flight Plan mode with a stored flight plan selected, and a specific leg selected, the waypoints are the endpoints of the selected leg.

In Point-To-Point mode these are manually selected waypoints (if there is an active flight plan, these default to the endpoints of the active leg).

Some of the calculated trip statistics are dashed when the selected leg of the active flight plan has already been flown.

- Desired Track (DTK) - DTK is shown as nnn° and is the desired track between the selected waypoints. It is dashed unless only a single leg is selected.
- Distance (DIS) - The distance is shown in tenths of units up to 99.9, and in whole units up to 9999.
- Estimated time en route (ETE) - ETE is shown as hours:minutes until less than an hour, then it is shown as minutes:seconds.
- Estimated time of arrival (ETA) - ETA is shown as hours:minutes and is the local time at the destination.
  - If in Point-To-Point mode then the ETA is the ETE added to the departure time.
  - If a flight plan other than the active flight plan is selected it shows the ETA by adding to the departure time all of the ETEs of the legs up to and including the selected leg. If the entire flight plan is selected, then the ETA is calculated as if the last leg of the flight plan was selected.
  - If the active flight plan is selected the ETA reflects the current position of the aircraft and the current leg being flown. The ETA is calculated by adding to the current time the ETEs of the current leg up to and including the selected leg. If the entire flight plan is selected, then the ETA is calculated as if the last leg of the flight plan was selected.
- En Route safe altitude (ESA) - The ESA is shown as nnnnnFT
- Destination sunrise and sunset times - These times are shown as hours:minutes and are the local time at the destination.

Foreword

Getting Started

Audio & Xpdr Ctrl

Com/Nav

FPL

Direct-To

Proc

Charts

Wpt Info

Map

Traffic

Terrain

Weather

Nearest

Music

Utilities

System

Messages

Symbols

Appendix

## 15.4.1 Point-To-Point Mode

The Trip Planning Point-to-Point mode shows trip calculations between two selected points: either two waypoints from the database or from your present position to a selected waypoint.



1. While viewing the Utilities page, touch the **Trip Planning** key.



2. Touch the **Mode** key to toggle to Point-to-Point.



3. Touch the **P.POS** key to toggle between using your present position as the From waypoint when selected or a waypoint selected from the database when **P.POS** is deselected. If **P.POS** is selected, the Lat/Lon of the present position will be shown in the From position.

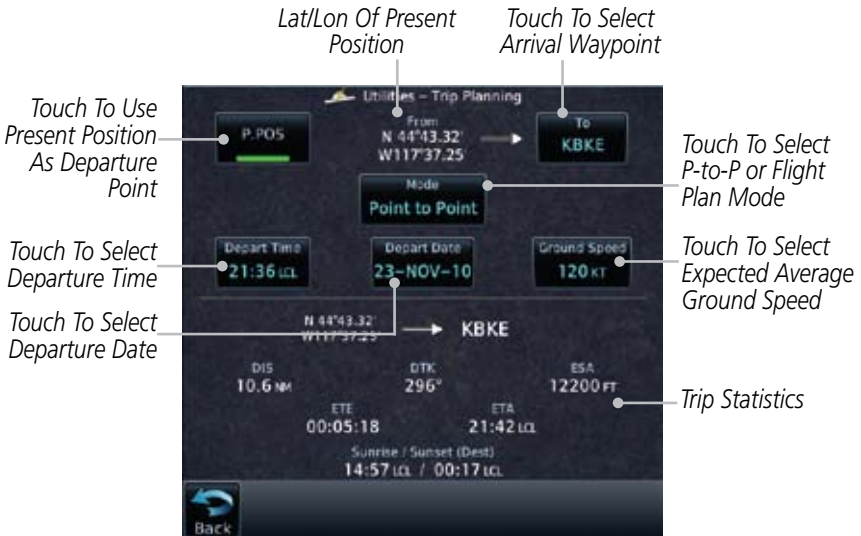

Figure 15-14 Utility Trip Planning Page (Point-To-Point Mode)



4. If **P.POS** is not selected for the From point, touch the **From** key and then use the keypad to select a waypoint from the database and touch **Enter**.





**Figure 15-15** Selecting a From Waypoint



5. Touch the **To** key and then use the keypad to select a waypoint from the database for the destination waypoint and touch **Enter**.



6. Touch the **Depart Time** key and then use the keypad to select the departure time (local time at From waypoint) and touch **Enter**.

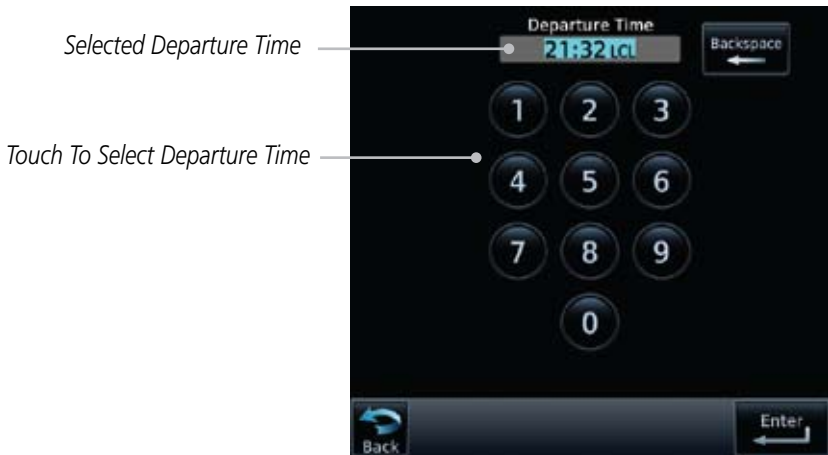

**Figure 15-16** Selecting Departure Time



7. Touch the **Depart Date** key and then the Departure Date page to select the departure year, month, and day and then touch **Enter**.

Foreword  
 Getting Started  
 Audio & Xpdr Ctrl  
 Com/Nav  
 FPL  
 Direct-To  
 Proc  
 Charts  
 Wpt Info  
 Map  
 Traffic  
 Terrain  
 Weather  
 Nearest  
 Music  
 Utilities  
 System  
 Messages  
 Symbols  
 Appendix



*Touch To Select Departure Year*



*Touch To Select Departure Month*



*Touch To Select Departure Day*

**Figure 15-17 Selecting Departure Date**

Ground Speed  
120 KT

8. Touch the **Ground Speed** key and then the keypad to select the average ground speed for the trip and touch **Enter**.

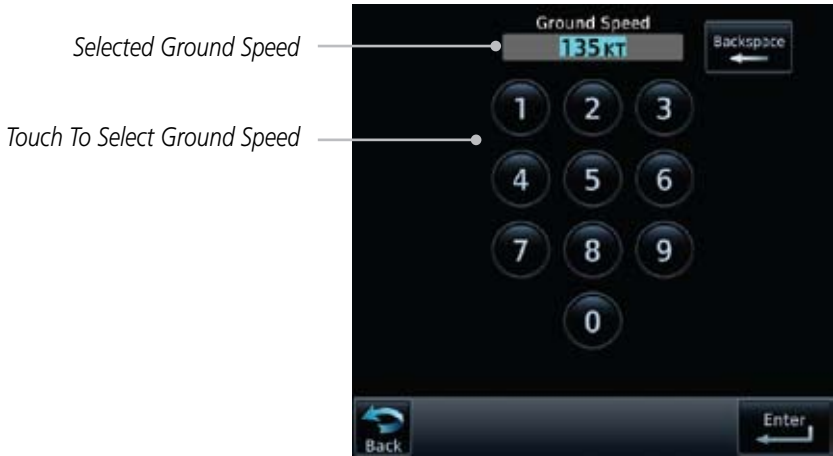

Figure 15-18 Selecting Expected Average Ground Speed

Compute Data

9. After completing the Trip Planning selections, the trip statistics will be shown in the lower half of the display.



Figure 15-19 Utility Trip Planning Page With Computed Data (Point-To-Point Mode)



**NOTE:** When Local Time is selected in the Setup-Date/Time feature, Sunrise/Sunset calculations in the Trip Planning feature are based on the From waypoint time zone. For instance, a flight plan originating in the Pacific time zone and ending in the Central time zone would show Sunset/Sunrise times at the destination in Pacific time. This potential offset does not occur when UTC time is used.

## 15.4.2 Flight Plan Mode

The Trip Planning Flight Plan mode shows trip calculations between two legs of the flight plan or the cumulative flight plan.



1. Touch the **Mode** key to select Flight Plan mode, if required.

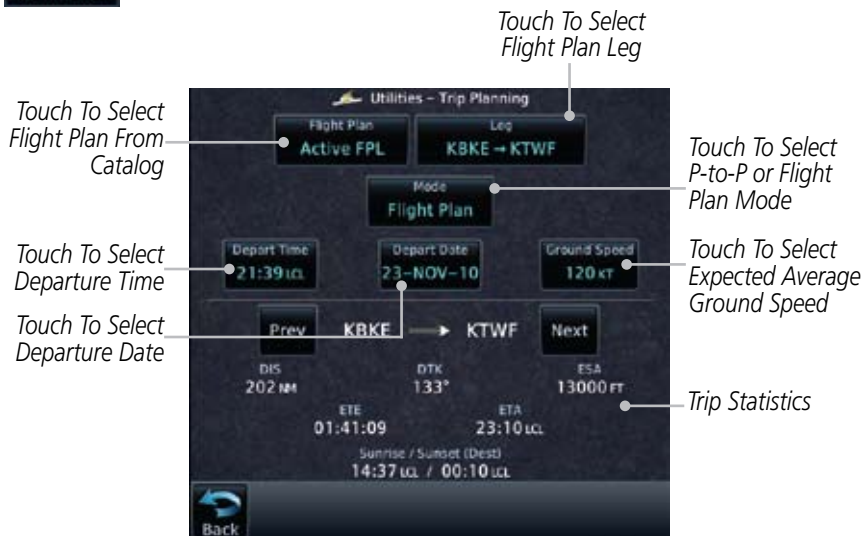

15-20 Utility Trip Planning Page (Flight Plan Mode)



2. Touch the **Flight Plan** key to select the flight plan.



Figure 15-21 Select Flight Plan

Leg  
KBKE → KTWF

3. Touch the **Leg** key to select the flight plan leg. If the “Cumulative” selection is chosen, statistics will relate to the entire flight plan.



*Touch To Select Flight Plan Leg (Cumulative FPL Shown)*

**Figure 15-22 Select Flight Plan Leg**

Depart Time  
21:36 UTC

4. Touch the **Depart Time** key and then use the keypad to select the departure time (local time at From waypoint) and touch **Enter**.

Depart Date  
23-NOV-10

5. Touch the **Depart Date** key and then the Departure Date page to select the departure year, month, and day and then touch **Enter**.

Ground Speed  
120 KT

6. Touch the **Ground Speed** key and then the keypad to select the average ground speed for the trip and touch **Enter**.

Foreword

Getting Started

Audio & Xpdr Ctrl

Com/Nav

FPL

Direct-To

Proc

Charts

Wpt Info

Map

Traffic

Terrain

Weather

Nearest

Music

Utilities

System

Messages

Symbols

Appendix

- Statistics for the current flight plan leg are displayed in the lower half of the display. The Cumulative flight plan is shown.



*Touch To View Statistics For Previous FPL Leg*

*Touch To View Statistics For Next FPL Leg*

*Trip Statistics*

**15-23 Utility Trip Planning Page Computed Data View (Flight Plan Mode)**

- Touch the **Next** key to view statistics for the next leg in the flight plan.



## 15.5 Fuel Planning

**Fuel Planning** — When equipped with fuel flow (FF) and/or fuel on board (FOB) sensors, this item displays fuel conditions along the active direct-to or flight plan. You may also manually enter fuel flow, ground speed (GS) and (in some instances) fuel on board figures for planning purposes. Fuel planning figures can be displayed not only for the currently active flight plan or direct-to, but also point-to-point between two specified waypoints and for any programmed flight plan. Fuel planning figures can be entered and displayed based upon one of three configurations:

- **No Fuel Sensors Connected** — In this instance fuel on board and fuel flow are manually entered in the unit start-up sequence and used to recalculate fuel on board as it is consumed. When fuel flow or fuel on board is manually entered, the figures are retained the next time you view the page (with fuel on board continuously recalculated).
- **Fuel Flow Sensor Installed, But No Fuel On Board Sensor** — Fuel on board is manually entered. Fuel flow is automatically provided by sensor. If fuel flow is manually entered (to override the sensor), it does not affect the FOB figure and is not retained the next time you view the page.
- **Fuel Flow and Fuel On Board Sensors Installed** — Fuel flow and fuel on board are automatically provided by sensors. Fuel on board can NOT be entered manually. Fuel Flow can be entered manually, but does not affect the FOB figure and is not retained the next time you view the page.

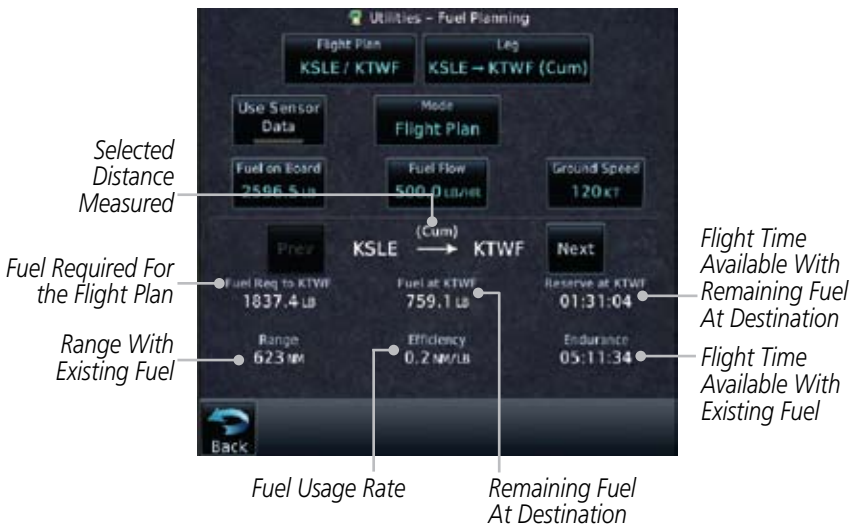

Figure 15-24 Utility Fuel Planning Page (Flight Plan Mode)

## 15.5.1 Point-To-Point Mode

The Fuel Planning Point-to-Point mode shows fuel calculations between two selected points: either two waypoints from the database or from your present position to a selected waypoint.

1. While viewing the Utilities page, touch the **Fuel Planning** key.
2. Touch the **Mode** key to toggle to Point-to-Point.
3. Touch the **P.POS** key to toggle between using your present position as the From waypoint when selected or a waypoint selected from the database when **P.POS** is deselected. If **P.POS** is selected, the Lat/Lon of the present position will be shown in the From position.

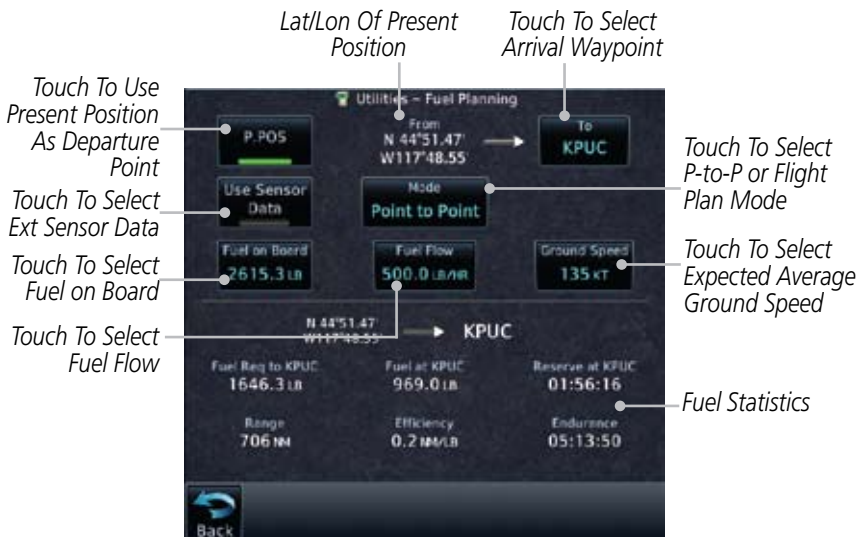

Figure 15-25 Utility Trip Planning Page (Point-To-Point Mode)





- If **P.POS** is not selected for the From point, touch the **From** key and then use the keypad to select a waypoint from the database and touch **Enter**.



Figure 15-26 Selecting the From Waypoint



- Touch the **To** key and then use the keypad to select a waypoint from the database for the destination waypoint and touch **Enter**.



- Touch the **Fuel on Board** key and then use the keypad to select the current amount of fuel on board and touch **Enter**.

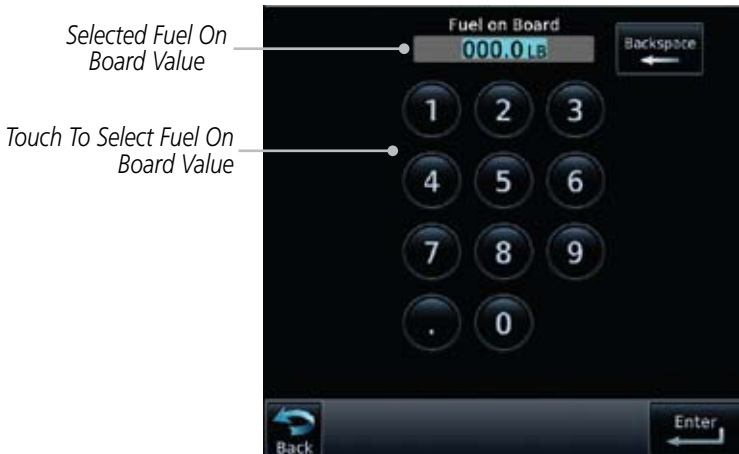

Figure 15-27 Selecting Current Fuel On Board



7. Touch the **Fuel Flow** key and then use the keypad to select the average fuel flow and touch **Enter**.

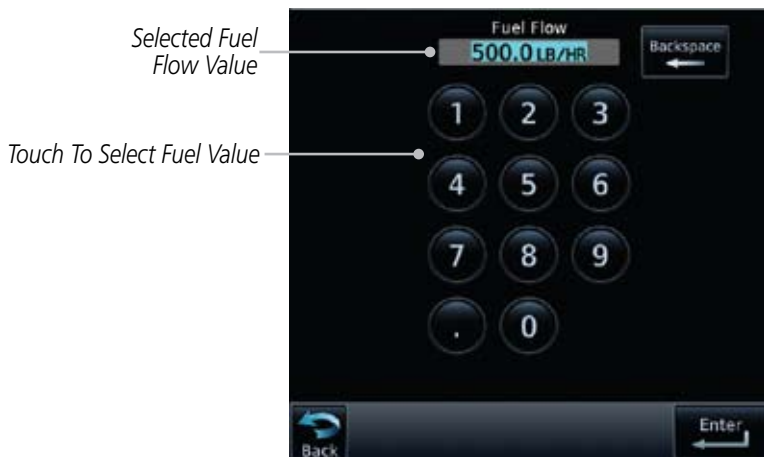

Figure 15-28 Selecting Fuel Flow

8. Touch the **Ground Speed** key and then the keypad to select the average ground speed for the trip and touch **Enter**.

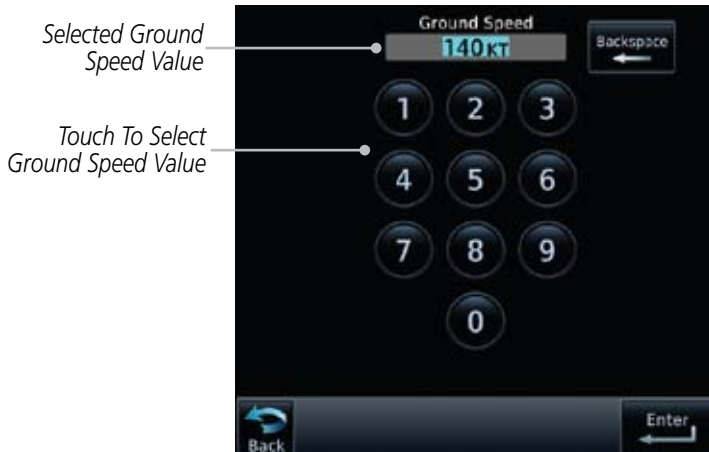

Figure 15-29 Selecting Ground Speed

9. Touch the **Use Sensor Data** key. When Sensor data is selected, the Fuel on Board and Fuel Flow values will be inserted by the external sensor and will not be selectable keys.



## 15.4.2 Flight Plan Mode

The Fuel Planning Flight Plan mode shows fuel calculations between two legs of the flight plan or the cumulative flight plan.

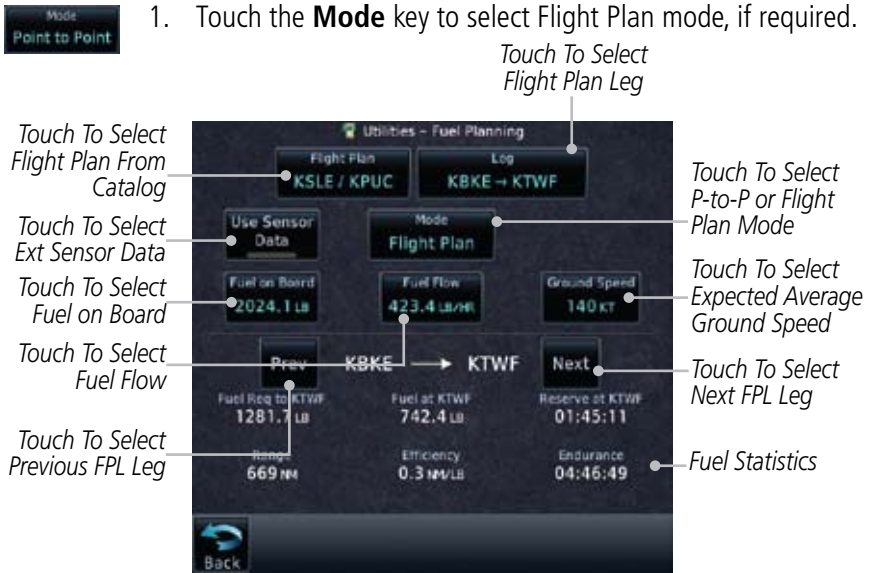

15-30 Utility Fuel Planning Page (Flight Plan Mode)

- Touch the **Mode** key to select Flight Plan mode, if required.
- Touch the **Flight Plan** key to select the flight plan.



Figure 15-31 Select Flight Plan

Foreword  
Getting Started  
Audio & Xpdr Ctrl  
Com/Nav  
FPL  
Direct-To  
Proc  
Charts  
Wpt Info  
Map  
Traffic  
Terrain  
Weather  
Nearest  
Music  
Utilities  
System  
Messages  
Symbols  
Appendix

Leg  
KBKE → KTWF

3. Touch the **Leg** key to select the flight plan leg. If the “Cumulative” selection is chosen, statistics will relate to the entire flight plan.



*Touch To Select Flight Plan Leg (Cumulative FPL Shown)*

**Figure 15-32 Select Flight Plan Leg**

Fuel on Board  
2615.3 LB

Fuel Flow  
500.0 LBS/H

Ground Speed  
120 KT

4. If desired, touch the **Fuel on Board** key and then use the keypad to select the Fuel on Board value and touch **Enter**.
5. If desired, touch the **Fuel Flow** key and then use the keypad to select the Fuel Flow value and touch **Enter**.
6. Touch the **Ground Speed** key and then the keypad to select the average ground speed for the trip and touch **Enter**.
7. Statistics for the current flight plan leg are displayed in the lower half of the display. The Cumulative flight plan is shown.
8. Touch the **Previous** and **Next** keys to view statistics for the previous and next legs in the flight plan.
9. If desired, touch the **Use Sensor Data** key. When Sensor data is selected, the Fuel on Board and Fuel Flow values will be inserted by the external sensor and will not be selectable keys.

Prev

Next

Use Sensor Data

## 15.6 DALT/TAS/Winds

**Density Alt / TAS / Winds** — indicates the theoretical altitude at which your aircraft performs depending upon several variables, including indicated altitude (Indicated ALT), barometric pressure (BARO) and total air temperature (TAT; the temperature, including the heating effect of speed, read on a standard outside temperature gauge). This item computes true airspeed (TAS) and density altitude, based upon the factors above. Also, this feature determines winds aloft — the wind direction and speed — and a head wind/tail wind component, based on true airspeed, aircraft heading (HDG) and ground speed.

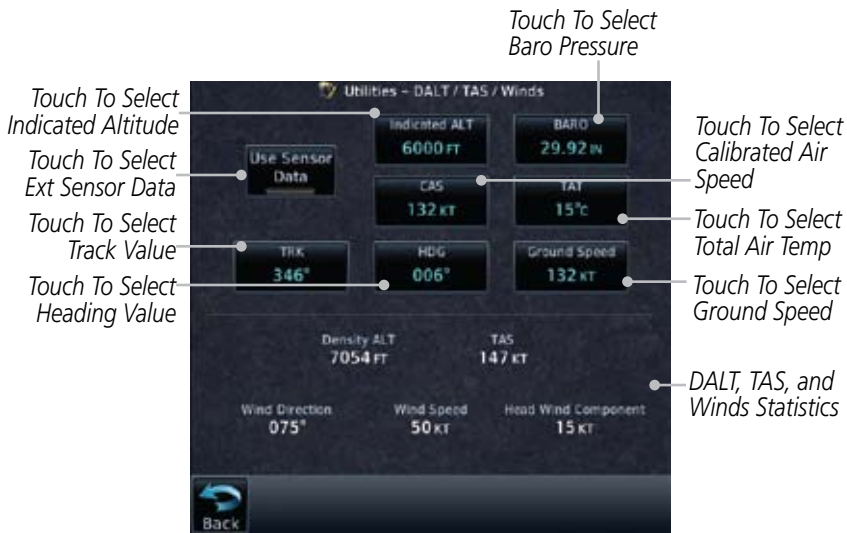
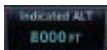

Figure 15-33 Utility DALT/TAS/Winds Page



1. If desired, touch the **Use Sensor Data** key. When Sensor data is selected, the Indicated Altitude, Calibrated Air Speed, Track, and Ground Speed values will be inserted by the external sensor and will not be selectable keys.

Foreword



2. Touch the **Indicated ALT** key and then the keypad to select the Indicated Altitude and then touch **Enter**.

Getting Started

Audio & Xpdr Ctrl

Com/Nav

FPL

Direct-To

Proc

Charts

Wpt Info

Map

Traffic

Terrain

Weather

Nearest

Music

Utilities

System

Messages

Symbols

Appendix

*Selected Indicated Altitude Value*

*Touch To Select Indicated Altitude Value*

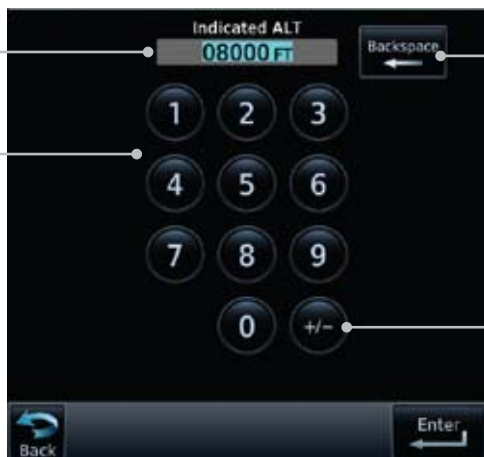

*Touch To Clear Values*

*Touch To Select Above Or Below Sea Level*

**Figure 15-34 Select Indicated Altitude Value**



3. Touch the **BARO** key and then the keypad to select the Barometric Pressure and then touch **Enter**.

Map

Traffic

Terrain

Weather

Nearest

Music

Utilities

System

Messages

Symbols

Appendix

*Selected Barometric Pressure Value*

*Touch To Select Barometric Pressure Value*

*Touch To Cancel Selection*



*Touch To Clear Values*

**Figure 15-35 Select Barometric Pressure Value**



4. Touch the **CAS** key and then the keypad to select the Calibrated Air Speed and then touch **Enter**.

Foreword

Getting Started

Audio & Xpdr Ctrl

Com/Nav

FPL

Direct-To

Proc

Charts

Wpt Info

Map

Traffic

Terrain

Weather

Nearest

Music

Utilities

System

Messages

Symbols

Appendix

Index



Figure 15-36 Select Calculated Air Speed Value



5. Touch the **TAT** key and then the keypad to select the Total Air Temperature and touch **Enter**.



Figure 15-37 Select Total Air Temperature Value

Foreword



6. Touch the **TRK** key and then the keypad to select the Track Angle and then touch **Enter**.

Getting Started

Audio & Xpdr Ctrl

Com/Nav

FPL

Direct-To

Proc

Charts

Wpt Info

Map

Traffic

Terrain

Weather

Nearest

Music

Utilities

System

Messages

Symbols

Appendix

Index



**Figure 15-38 Select Track Angle Value**



7. Touch the **HDG** key and then the keypad to select the Heading value and then touch **Enter**.

Map

Traffic

Terrain

Weather

Nearest

Music

Utilities

System

Messages

Symbols

Appendix

Index



**Figure 15-39 Select Heading Value**



8. Touch the **Ground Speed** key and then the keypad to select the average ground speed for the trip and then touch **Enter**.



## 15.7 Clean Screen Mode

The Clean Screen mode makes the touchscreen inactive so the display can be manually cleaned. The front bezel, keypad, and display can be cleaned with a microfiber cloth or with a soft cotton cloth dampened with clean water. DO NOT use any chemical cleaning agents. Care should be taken to avoid scratching the surface of the display.



1. While viewing the Utilities page group, touch the **Clean Screen** key to start Screen Cleaning Mode.



Figure 15-40 Utilities Page



2. Touch the **HOME** key to exit Screen Cleaning Mode.

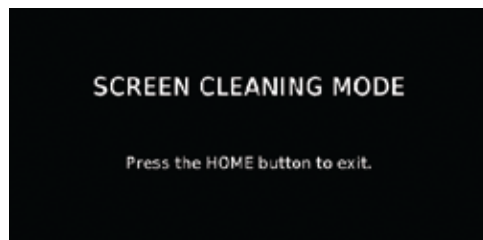

Figure 15-41 Screen Cleaning Mode

Foreword

Getting  
Started

Audio &  
Xpdr Ctrl

Com/Nav

FPL

Direct-To

Proc

Charts

Wpt Info

Map

*This page intentionally left blank*

Traffic

Terrain

Weather

Nearest

Music

Utilities

System

Messages

Symbols

Appendix



The System function allows you to change unit settings, customize operation to your preferences, and check on the operation of your unit. The System pages cover System Status, GPS Status, External LRUs, Setup, Alerts, Units, Audio, Ownship, and the Backlight control function.



1. From the Home page, touch the **System** key.



Figure 16-1 System Home Page



2. Touch the desired key to reach that function. To return to the System page, touch the **Back** key.

Foreword  
 Getting Started  
 Audio & Xpdr Ctrl  
 Com/Nav  
 FPL  
 Direct-To  
 Proc  
 Charts  
 Wpt Info  
 Map  
 Traffic  
 Terrain  
 Weather  
 Nearest  
 Music  
 Utilities  
**System**  
 Messages  
 Symbols  
 Appendix



**Figure 16-2 System Function Summary**

## 16.1 System Status

The System status page of the System function provides information about the GTN unit and the equipment attached to it. This information is useful if it is necessary to contact Customer Service. The System Status page shows the System ID and serial number for the GTN unit, hardware and software versions, as well as a list of the installed databases.

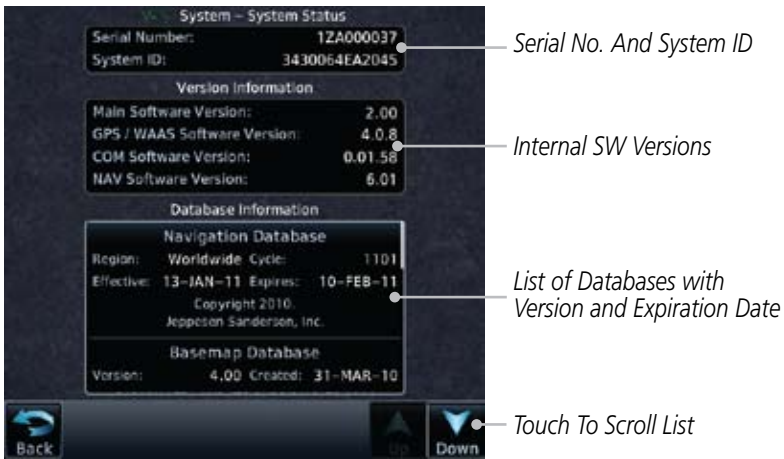

Figure 16-3 System Function System Status Page Description

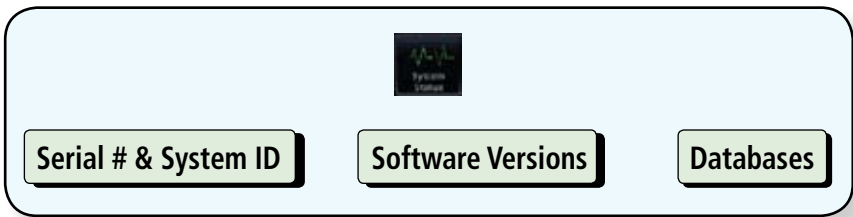

Figure 16-4 System Status Functional Diagram

Foreword  
Getting Started  
Audio & Xpdr Ctrl  
Com/Nav  
FPL  
Direct-To  
Proc  
Charts  
Wpt Info  
Map  
Traffic  
Terrain  
Weather  
Nearest  
Music  
Utilities  
System  
Messages  
Symbols  
Appendix  
Index



1. While viewing the System page, touch **System Status**.
2. Use the **Up** and **Down** arrow keys as needed to view the Database Information.
3. Touch the **Back** key to return to the System page.

## 16.1.1 Serial Number and System ID

The System Status section shows the unit Serial Number and the System ID.

## 16.1.2 Version Information

The software versions of the GTN unit are displayed. This information is useful when contacting Customer Support.

## 16.1.3 Database Information

The System Status page lists the name of the database, its version, and expiration date.



---

**NOTE:** *The data contained in the terrain and obstacle databases comes from government agencies. Garmin accurately processes and cross-validates the data, but cannot guarantee the accuracy and completeness of the data.*

---

The following databases are stored on Supplemental Data Cards provided by Garmin:

- **Terrain** – The terrain database contains terrain mapping data. It is updated periodically and has no expiration date.
- **Obstacles** – The obstacles database contains data for obstacles, such as towers, that pose a potential hazard to aircraft. Obstacles 200 feet and higher are included in the obstacle database. It is very important to note that not all obstacles are necessarily charted and therefore may not be contained in the obstacle database. This database is updated on a 56-day cycle. Obstacles will still be shown after the database has expired.
- **SafeTaxi** – The SafeTaxi database contains detailed airport diagrams for selected airports. These diagrams aid in following ground control instructions by accurately displaying the aircraft position on the map in relation to taxiways, ramps, runways, terminals, and services. This database is updated on a 56-day cycle. SafeTaxi will still be shown after it has expired.

- **FliteCharts** – The FliteCharts database contains procedure charts for the United States only. This database is updated on a 28-day cycle. If not updated within 180 days of the expiration date, FliteCharts no longer functions.
- **Basemap** - The Basemap database contains land and water data, such as roads, boundaries, rivers, and lakes.
- **Aviation** – The Navigation database is updated on a 28 day cycle. Navigation database updates are provided by Garmin and may be downloaded from the Garmin web site “fly.garmin.com” onto a Garmin provided Supplemental Datacard. Contact Garmin at fly.garmin.com for navigation database updates and update kits.
- **Charts** – The optional ChartView database is updated on a 14 day cycle. The ChartView database is provided directly from Jeppesen. Contact Jeppesen (www.jeppesen.com) for ChartView subscription and update information.

Foreword

Getting Started

Audio & Xpdr Ctrl

Com/Nav

FPL

Direct-To

Proc

Charts

Wpt Info

Map

Traffic

Terrain

Weather

Nearest

Music

Utilities

System

Messages

Symbols

Appendix

Foreword

Getting Started

Audio &amp; Xpdr Ctrl

Com/Nav

FPL

Direct-To

Proc

Charts

Wpt Info

Map

Traffic

Terrain

Weather

Nearest

Music

Utilities

System

Messages

Symbols

Appendix

Index

Database Name	Function	Where Stored	Update Cycle	Provider	Notes
Aviation	Airport, NAVAID, Waypoint, and Airspace information	Internal memory	28 days	fly.garmin.com	Updates installed via SD card and copied into internal memory
SafeTaxi	Airport surface diagrams	Internal memory	56 days	fly.garmin.com	Updates installed via SD card and copied into internal memory
Terrain	Topographic map, Terrain/TAWS	SD card	As required	fly.garmin.com	
Obstacle	Obstacle information for map, and TAWS	Internal memory	56 days	fly.garmin.com	Updates installed via SD card and copied into internal memory
Basemap	Boundary and road information	Internal Memory	As required	fly.garmin.com	Updates installed via SD card and copied into internal memory
FliteCharts	FAA-published terminal procedures	SD card	28 days	fly.garmin.com	Disables 180 days after expiration date.
ChartView	Jeppesen terminal procedures	SD card	14 days	Contact Jeppesen	Optional feature that requires Garmin dealer enablement. Disables 70 days after expiration date.

**Table 16-1 Database List**

Index



## 16.2 GPS Status

### 16.2.1 GPS Status Page

The GPS Status Page provides a visual reference of GPS receiver functions, including current satellite coverage, GPS receiver status, position accuracy, and displays your present position (in latitude and longitude) and altitude. The GPS Status Page also displays the current UTC time at the top right of the page.

The Satellite Status Page is helpful in troubleshooting weak (or missing) signal levels due to poor satellite coverage or installation problems. You may wish to refer to this page occasionally to monitor GPS receiver performance and establish a normal pattern for system operation. Should problems occur at a later date, you may find it helpful to have an established baseline from which to compare.



1. While viewing the System page, touch **GPS Status**.

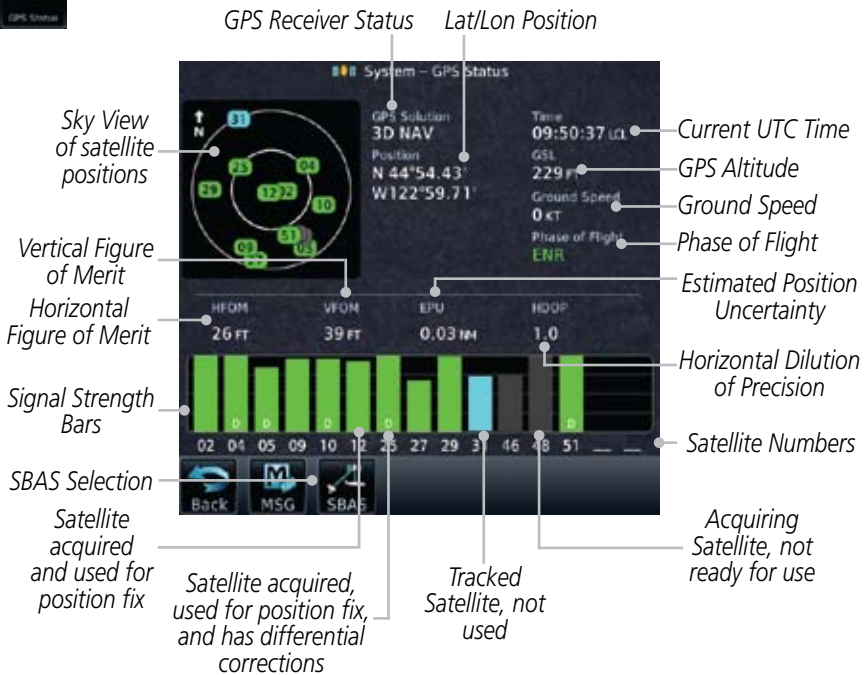

Figure 16-5 GPS Status Page



2. If desired, touch the **SBAS** key to select an SBAS provider. The SBAS list is based on the Aviation database.

3. Touch the key for the desired SBAS provider.
4. Touch the **Back** key to return to the System Status page.



As the GPS receiver locks onto satellites, a signal strength bar appears for each satellite in view, with the appropriate satellite number (01-32, SBAS satellites will have higher numbers) underneath each bar. The progress of satellite acquisition is shown in three stages:

Graph Symbol	Description
No signal strength bars	The receiver is looking for the satellites indicated.
Grey signal strength bars	The receiver has found the satellite(s) and is collecting data.
Yellow signal strength bars	The receiver has collected the necessary data but the satellite is not being used in the position solution as it has been excluded.
Cross-hatch cyan signal strength bars	The receiver has found the satellite(s) but it has been excluded by the FDE program as a faulty satellite.
Solid cyan signal strength bars	The receiver has collected the necessary data, but is not using the satellite in the position solution.
Solid green signal strength bars	The receiver has collected the necessary data and the satellite is being used in the position solution.
D	The "D" character inside the bars indicates differential corrections (e.g. WAAS) are being used for that satellite.

**Table 16-2 Signal Strength Bar Graph Description**

The Time and other data may not be displayed until the unit has acquired enough satellites for a fix.

The sky view display at the left of the page shows the satellites currently in view as well as their respective positions. The outer circle of the sky view represents the horizon (with north at the top of the circle); the inner circle represents 45° above the horizon and the center point shows the position directly overhead.

Each satellite has a 30-second data transmission that must be collected (hollow signal strength bar) before the satellite may be used for navigation (solid signal strength bar). Once the GPS receiver has determined your position, the GTN unit indicates your position, altitude, track and ground speed. The GPS

receiver status field also displays the following messages under the appropriate conditions:

GPS Signal Message	Description
Acquiring	The GPS receiver is acquiring satellites for navigation. In this mode, the receiver uses satellite orbital data (collected continuously from the satellites) and last known position to determine the satellites that should be in view.
3D Nav	The GPS receiver is in 3D navigation mode and computes altitude using satellite data.
3D Diff Nav	The GPS receiver is in 3D navigation mode and differential corrections are being used.
LOI	The "LOI" (Loss Of Integrity) annunciator (bottom left corner of the screen) indicates that satellite coverage is insufficient to pass built-in integrity monitoring tests.

**Table 16-3 GPS Signal Messages**

The GPS Status Page also indicates the accuracy of the position fix, using Horizontal Figure of Merit (HFOM), Vertical Figure of Merit (VFOM), and Estimated Position Uncertainty (EPU). HFOM and VFOM represent the 95% confidence levels in horizontal and vertical accuracy. The lowest numbers are the best accuracy and the highest numbers are worse. EPU is the horizontal position error estimated by the Fault Detection and Exclusion (FDE) algorithm, in feet or meters.



**NOTE:** Operating outside of an SBAS service area with SBAS enabled may cause elevated EPU values to be displayed on the satellite status page. Regardless of the EPU value displayed, the LOI annunciation is the controlling indication for determining the integrity of the GPS navigation solution.



**NOTE:** The FDE Prediction program is used to predict FDE availability. This program must be used prior to all oceanic or remote area flights for all operators using the GTN as a primary means of navigation under FAR parts 91, 121, 125, and 135. The FDE program is part of the GTN trainer, available for download from the GTN product information page on Garmin's web site, [www.garmin.com](http://www.garmin.com).

If the GTN has not been operated for a period of six months or more, acquiring satellite data to establish almanac and satellite orbit information can take 5 to 10 minutes.

The Time and other data may not be displayed until the unit has acquired enough satellites for a fix.

## 16.2.2 Satellite-Based Augmentation System (SBAS)

SBAS is a system that supports wide area, or regional, augmentation through the use of additional satellite broadcast messages. WAAS, EGNOS, and MSAS are known SBAS providers.

At the time of printing, SBAS providers support the following areas:

- WAAS provides SBAS service for Alaska, Canada, the 48 contiguous states, and most of Central America.
- EGNOS provides SBAS service for most of Europe and parts of North Africa.
- MSAS provides SBAS service for Japan only.

1. While viewing the System page, touch **GPS Status**.
2. If desired, touch the **SBAS** key to select an SBAS provider. The SBAS list is based on the Aviation database.
3. Touch the key for the desired SBAS provider.

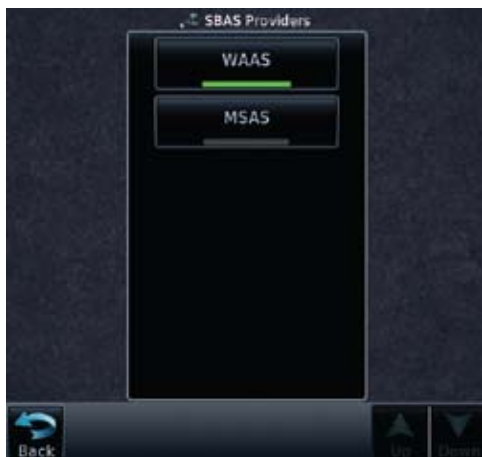

Figure 16-6 SBAS Selection Page

4. Touch the **Back** key to return to the System Status page.

Foreword  
Getting Started  
Audio & Xpdr Ctrl  
Com/Nav  
FPL  
Direct-To  
Proc  
Charts  
Wpt Info  
Map  
Traffic  
Terrain  
Weather  
Nearest  
Music  
Utilities  
System  
Messages  
Symbols  
Appendix  
Index



## 16.3 External LRUs

The External LRU page displays the external equipment connected to the GTN and their connection status.

1. While viewing the System page, touch the **External LRUs** key.

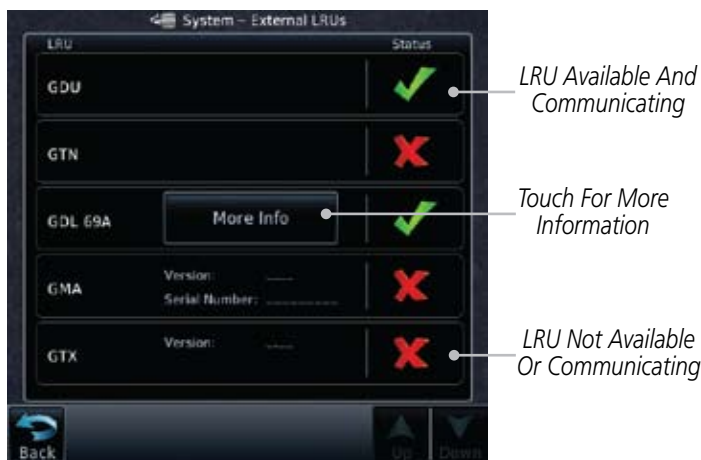
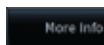

Figure 16-8 External LRU Page

2. When more information is available about the listed units, touch the **More Info** key to view the information.



### 16.3.1 GDL 69 (and GDL 69A) Status

The GDL 69 Status page displays the serial numbers for the Data Radio for the GDL 69/69A and the Audio Radio for the GDL 69A. Subscription status displays the level of service available for your particular subscription. The Weather Products section lists the products available for your particular subscription.

1. While viewing the External LRUs page, touch **More Info** for the GDL LRU.

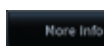



Figure 16-9 GDL 69/69A Status Page

2. Touch the **Menu** key to display the GDL 69 Status Menu.



Figure 16-10 GDL Status Menu

3. Touch the **Lock Activation** key if this is for the initial subscription or a change in the subscription. Touch the **OK** key to continue the operation.

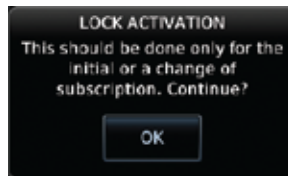
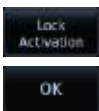

Figure 16-11 Lock Activation

4. Touch the **Back** key to return to the System page.



## 16.4 Setup

System Setup allows setting the time convention, Com channel spacing, crossfilling to a second GTN, and Nearest Airport search filtering.

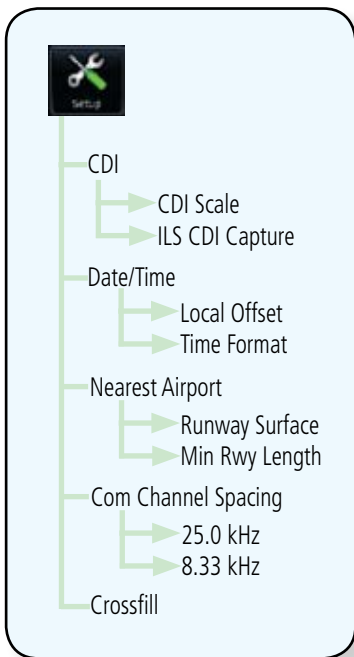

**Figure 16-12 System Setup Functions**



## 16.4.1 System Setup

System Setup function allows setting the time convention, Com channel spacing, crossfilling to a second GTN, and Nearest Airport search filtering.



1. While viewing the System page, touch the **Setup** key.

Touch Key to Select CDI Scale

Touch Key to Set ILS CDI Capture

Touch Key to Set Time Offset

Touch Key to Set Time Format



Touch Key to Set Runway Surface Type

Touch Key to Set Min Runway Length

Touch Key to Set Com Channel spacing

Touch Key to Enable Crossfill With Dual Units

Figure 16-13 System Setup Page



2. After making the desired selections, touch the **Back** key to return to the Setup page.

### 16.4.1.1 Date/Time

The Date/Time setting provides selection of time format (local or UTC; 12- or 24-hour). UTC (also called “GMT” or “Zulu”) date and time are calculated directly from the GPS satellites’ signals and cannot be changed.



Current Selected Date and Time

Touch To Select Local Time Offset

Touch To Select Time Format

Figure 16-14 System Date and Time Setup



1. While viewing the System Setup page, touch **Local Offset** to set the time offset for local time.



2. Use the keypad to select the desired local offset and then touch **Enter**.

Foreword  
Getting Started  
Audio & Xpdr Ctrl  
Com/Nav  
FPL  
Direct-To  
Proc  
Charts  
Wpt Info  
Map  
Traffic  
Terrain  
Weather  
Nearest  
Music  
Utilities  
System  
Messages  
Symbols  
Appendix  
Index

Time Format  
Local 12 hour

3. While viewing the System Setup page, touch the **Time Format** key to select local 12 hour, local 24 hour, or UTC time.

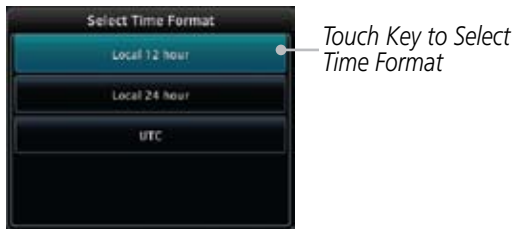
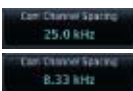

**Figure 16-15 Select System Time Format**

4. Touch the key for the desired time format.

### 16.4.1.2 Com Channel Spacing

Com transceiver channel spacing may be selected between 8.33 kHz and 25.0 kHz.



While viewing the System Setup page, touch **Channel Spacing** to toggle between 8.33 kHz and 25.0 kHz channel spacing.

### 16.4.1.3 Nearest Airport Criteria

Nearest Airport Criteria defines the surface type and minimum runway length used when determining the 25 nearest airports to display on the Nearest Airport Page. A minimum runway length and/or surface type may be entered to prevent airports with small runways, or runways that do not have an appropriate surface, from being displayed. The default settings are “0 feet (or meters)” for runway length and “any” for runway surface type.



**Figure 16-16 Select Nearest Airport Criteria**



1. While viewing the System Setup page, touch **Runway Surface** to display the options. Touch the desired surface type.



Touch to Select Any Runway Surface

Touch to Select Hard Runway Surfaces Only

Touch to Select Hard or Soft Runway Surfaces

Touch to Select Water Surfaces Only

**Figure 16-17 Nearest Airport Runway Surface Type**



2. Touch **Minimum Runway Length** to display the keypad for selecting the minimum runway length. Select the desired minimum runway length with the numeric keypad. A selection of "0" will allow any length.



Touch Key to Delete Values

Touch Keys to Set Values

**Figure 16-18 Nearest Airport Runway Length**



3. After selecting the runway length, touch the **Enter** key to save the entered values or touch the **Back** key to return to the System Setup page without saving a value.

### 16.4.1.4 Crossfill

Dual units may be interfaced to crossfill information between the two units. This option will not be available unless dual units are configured.

When Crossfill is turned on with one GTN, it is automatically turned on in the other GTN. Some items are always crossfilled regardless of the crossfill setting; others are dependent on the crossfill setting.



**NOTE:** Upon crossfill being activated, the GTNs may take up to 10 seconds to crossfill the flight plans. The pilot must verify the flight plan in each unit prior to use.

This data is always crossfilled:

- User waypoints
- Flight plan catalog
- Alerts (traffic popup acknowledgement, missed approach waypoint popup acknowledgement, altitude leg popup acknowledgement)
- External sensors (transponder status and commands, synchro heading)
- System setup:
  - Favorite NAV frequencies
  - Date/Time convention
  - Nearest airport criteria
  - Units (Nav angle, Distance/Speed, etc.)
  - Favorite COM frequencies
  - Ownship icon
  - CDI Scale setting
  - ILS CDI Capture setting

This data is crossfilled only if crossfill is turned on by the pilot:

- Active navigation (flight plan)

1. While viewing the System Setup page, touch the **Crossfill** key to toggle between Enabled and Disabled Crossfill.

2. When Crossfill is about to be enabled, you will be prompted to note that data will be overwritten in the other unit. Touch **OK** to enable Crossfill or touch **Cancel** to return to the System Setup page without enabling Crossfill.



or





**Figure 16-19 Confirming Crossfill Selection**

### 16.4.1.5 CDI Scale Selection

The CDI source and ILS CDI Capture type may be selected manually or automatically. The selected CDI Scale will be reflected in the annunciation bar at the bottom of the display.



**Figure 16-20 CDI Selection**

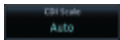

1. While viewing the System Setup page, touch the **CDI Scale** key to allow automatic selection or to choose a CDI Scale manually.



**Figure 16-21 CDI Scale Selection**



2. Touch the **ILS CDI Capture** key to select automatic or manual. This feature enables the unit to automatically switch from GPS to VLOC on an ILS approach. See *Procedures-ILS Approaches* for more detail on ILS approaches.

## 16.5 Alerts Settings

The Alerts Setup page controls two functions: Arrival Alerts and Airspace Alerts. Arrival Alerts, when active, will generate a message when the aircraft is within the selected proximity of the destination. Airspace Alerts generate a message and filtering of the Nearest Airspace list. The altitude component of Airspace Alerts are dependent on both aircraft and airspace altitude and the values set for the Altitude Buffer.

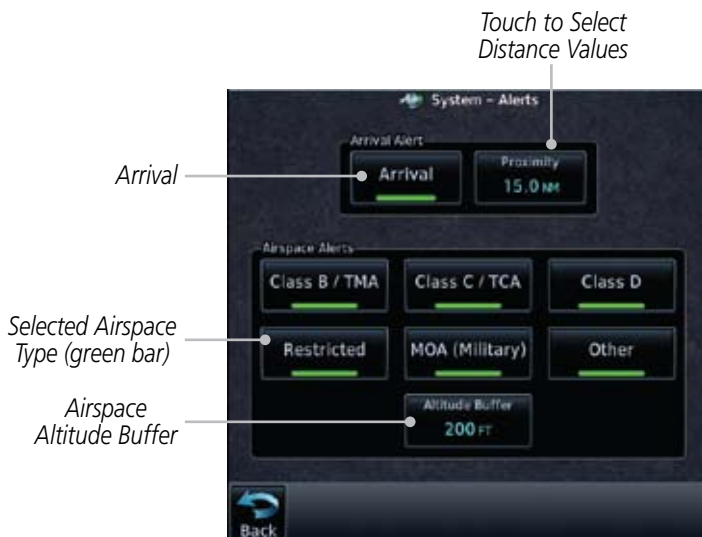
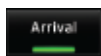

Figure 16-22 Alerts Setup Page

1. While viewing the System page, touch the **Alerts** key.
2. Touch the **Arrival** key to toggle activation. A green bar will appear when it is active.





3. Touch the **Proximity** key to set the Proximity distance values. A numeric keypad will appear. Select the desired values and then touch **Enter**.

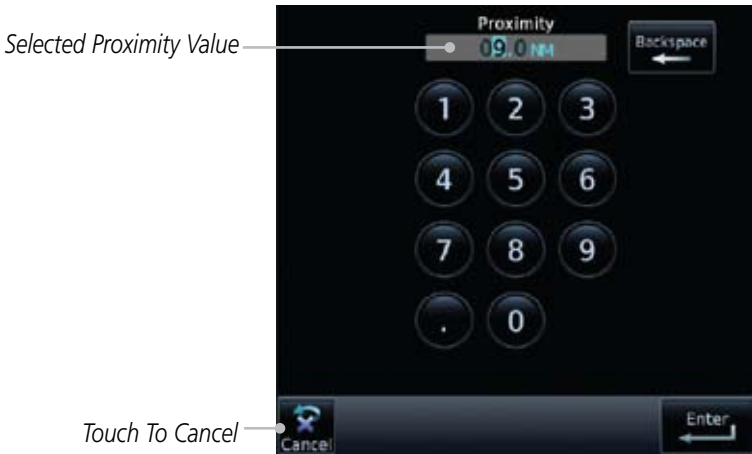

**Figure 16-23** Airspace Alert Proximity Selection



4. Touch the **Altitude Buffer** key to set the buffer altitude value. A numeric keypad will appear. Select the desired value and then touch **Enter**.

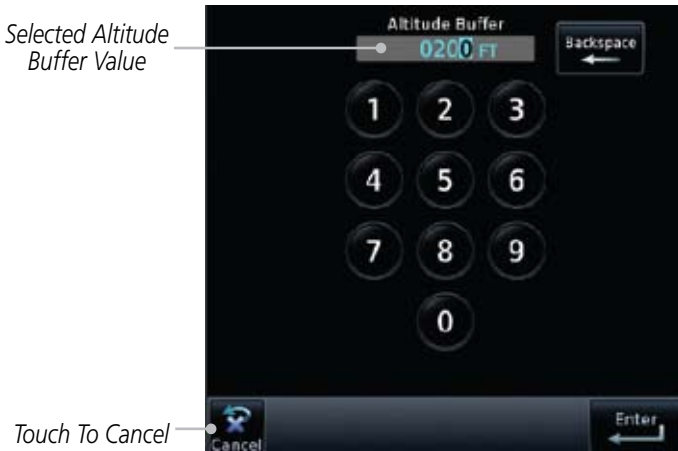

**Figure 16-24** Airspace Alert Altitude Buffer Selection

5. Touch the Airspace type keys to toggle activation. A green bar will appear when it is active.

## 16.6 Units Settings

The Units Setup page allows you to select the conventions for the various units that are displayed.

Units Type	Units Values
Nav Angle	Magnetic (°), True (°T), User (°u)
Magnetic Variation	Enter numeric value, E or W
Temperature	Celsius (°C) or Fahrenheit (°F)
Fuel	Gallons (GAL) or Pounds (LB)

Table 16-4 System Units Setup

### 16.6.1 Setup Units

Use these settings to set the units for values displayed in the unit operation.

1. While viewing the System page, touch the **Units** key.



Touch Key to Set Units

Figure 16-25 System Units Page



2. Touch the key for the desired units. A window with a list of unit values will appear. Touch the desired value on the list.



Figure 16-26 Setup Units Selection Windows



3. After making the desired selections, touch the **Back** key to return to the Setup page.

## 16.6.2 Setting a User-Configured (Manual) Nav Angle

There are three variation (heading) options: Magnetic, True, and User. If “Magnetic” is selected, all track, course and heading information is corrected to the magnetic variation computed by the GPS receiver. The “True” setting references all information to true north. The “User” selection allows the pilot to enter values between 0° and 179° E or W.



**NOTE:** *When changing the Nav angle, the DTK on the Flight Plan page for an approach does not change until that approach is reloaded.*

1. While viewing the System page, touch **Units** key.
2. Touch the **Nav Angle** key and then the **User** key.



Figure 16-27 Nav Angle Selections

3. After User is selected, touch the **Magnetic Variation** key to set the value.



Figure 16-28 Magnetic Variation is Available for Editing



4. Touch the keys on the numeric keypad to set the Magnetic Variation and then touch **Enter**.



**Figure 16-29** Numeric Keypad for Setting Manual Magnetic Variation

5. The User Nav Angle value will be used for all angular values. Remember to change the value when traveling to an area requiring another value.



**Figure 16-30** User (Manual) Magnetic Variation

## 16.7 Audio

The Audio Settings allows the adjustment of the volume the click sound when controls are touched.

1. While viewing the System page, touch **Audio** key.



*Touch The Arrow Keys To Adjust Click Volume*

*Touch To Select Voice (TAWS Only)*

**Figure 16-31 System Audio Selection**



2. Touch the Arrow keys to adjust the Key Click Volume.
3. Touch the **Male** or **Female** key to select the audio voice type.

## 16.8 Ownship Settings

The Ownship setting allows the selection of an aircraft type for the ownship icon.



1. While viewing the System page, touch **Ownship** key.



*Selected  
Ownship Type*

**Figure 16-32 Ownship Selection**

2. Touch the desired type of aircraft for the ownship symbol.

## 16.9 Backlight Settings

The backlighting of the display and bezel keys can be adjusted automatically or manually. The default setting (automatic backlighting adjustment) uses photocell technology to automatically adjust for ambient lighting conditions. Photocell calibration curves are pre-configured to optimize display appearance through a broad range of cockpit lighting conditions. A manual offset creates a deviation from the normal curve. Manual adjustments may be made from +100% to -10%. The negative adjustment is limited to prevent the backlight from being accidentally decreasing the backlight to the point where the display of information could not be seen.

Manual backlighting adjustment can be accomplished using the existing instrument panel dimmer bus or the following procedures.

1. While viewing the System page, touch the **Backlight** key.
2. Touch the **Arrow** keys to adjust the Backlight level.

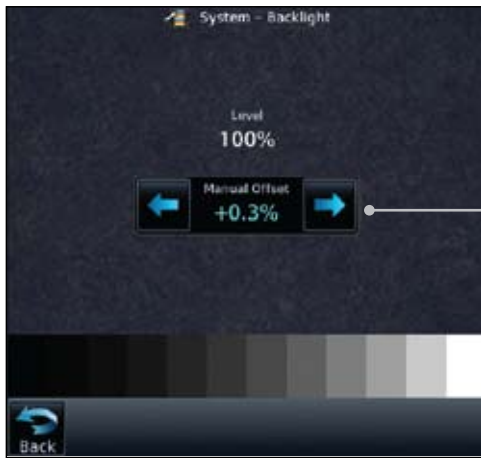

*Touch The Arrow Keys For Manual Offset*

**Figure 16-33 Backlight Level Selection**

3. After making the desired selections, touch the **Back** key to return to the System page.



## 17 MESSAGES



When a Message has been issued by the unit, the Message (**MSG**) key/annunciator in the lower left of the display will blink. Touch the **MSG** key to view the messages. After viewing the messages, touch the **Back** key to return to the previously viewed page. The Messages provide an aid to troubleshooting system operation.

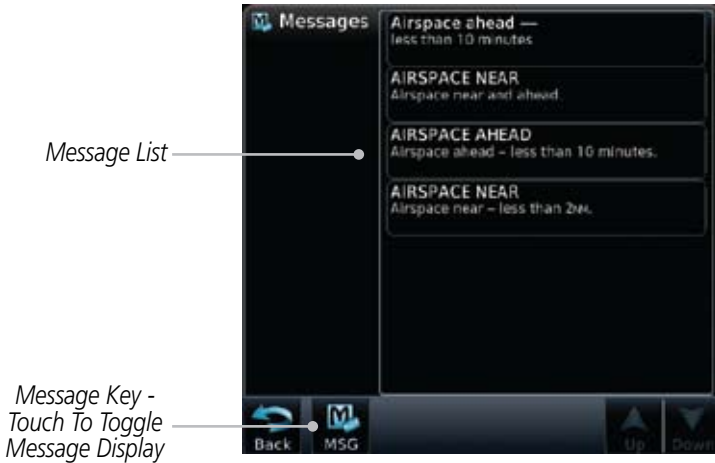

Figure 17-1 Message Display

Message	Description	Action
<b>ABORT APPROACH</b> - GPS approach no longer available.	This message is triggered outside the MAP if the GTN system can no longer provide approach level of service. Vertical guidance will be removed from the external CDI/HSI display.	Initiate a climb to the MSA or other published safe altitude, abort the approach, and execute a non-GPS based approach.
<b>AIRSPACE ALERT</b> - Inside airspace.	The aircraft inside an airspace type for which alerts are configured.	No action is necessary; message is informational only.

Foreword  
Getting Started  
Audio & Xpdr Ctrl  
Com/Nav  
FPL  
Direct-To  
Proc  
Charts  
Wpt Info  
Map  
Traffic  
Terrain  
Weather  
Nearest  
Music  
Utilities  
System  
Messages  
Symbols  
Appendix

Message	Description	Action
<b>AIRSPACE ALERT -</b> Airspace within 2 nm and entry in less than 10 minutes.	The aircraft is within 2 nm and predicted to enter an airspace type, within 10 minutes, for which alerts are configured.	No action is necessary; message is informational only.
<b>AIRSPACE ALERT -</b> Airspace entry in less than 10 minutes.	The aircraft is predicted to enter an airspace type, within 10 minutes, for which alerts are configured.	No action is necessary; message is informational only.
<b>AIRSPACE ALERT -</b> Within 2 nm of airspace.	The aircraft is within 2nm of an airspace type for which alerts are configured.	No action is necessary; message is informational only.
<b>APPROACH NOT ACTIVE -</b> Do not continue GPS approach.	GPS approach could not transition to active (e.g., the GTN is on an approach and did not have the required HPL/VPL to get into at least LNAV, so is still in TERM).	Abort the approach, and execute a non-GPS based approach.
<b>AUDIO PANEL -</b> Audio panel needs service.	The GMA 35 is reporting to the GTN that it needs service. The audio panel may continue to function.	Contact dealer for service.
<b>AUDIO PANEL -</b> Audio panel is inoperative or connection to GTN is lost.	The GTN is configured for Garmin audio panel control (GMA 35) and the GTN cannot communicate with the GMA 35. No control of the GMA 35 will be possible.	Remove power from the GMA 35 audio panel by pulling the circuit breaker labeled "Audio." The pilot will be able to communicate with the Com 2 radio. Contact dealer for service.



Message	Description	Action
<b>APPROACH DOWNGRADE -</b> Approach downgraded. Use LNAV minima.	Approach has been downgraded from LPV or LNAV/VNAV, to an LNAV approach. Vertical guidance will be removed from the external CDI/HSI display.	Continue to fly the approach using published LNAV minimums.
<b>APR GUIDANCE AVAILABLE -</b> Press "Enable APR Output" before selecting APR on autopilot.	The GTN is configured for KAP140/KFC225 autopilot, and approach guidance is now available.	Press the "Enable APR Output" button on the GTN, this will cause the autopilot to go into ROL mode. Engage the autopilot into approach mode. See section 6.14 for additional information.
<b>CDI SOURCE -</b> Select appropriate CDI source for approach.	Aircraft is on a GPS approach but CDI is set to VLOC, or aircraft is on VLOC approach and CDI is set to GPS <i>and</i> aircraft is less than 2 nm from the FAF.	Select the appropriate CDI source for approach.
<b>CDI/HSI FLAG -</b> Main lateral/vertical flag on CDI/HSI is inoperative.	The Main Lateral Superflag or Main Vertical Superflag output has been turned off due to an over-current condition.	Verify course guidance is valid and correct by crosschecking with the GTN on-screen CDI and other navigational equipment. Contact dealer for service.
<b>COM RADIO -</b> Com radio needs service.	The com radio is reporting that it needs service. The com radio may continue to function.	Contact dealer for service.

- Foreword
- Getting Started
- Audio & Xpdr Ctrl
- Com/Nav
- FPL
- Direct-To
- Proc
- Charts
- Wpt Info
- Map
- Traffic
- Terrain
- Weather
- Nearest
- Music
- Utilities
- System

Messages

Symbols

Appendix

Foreword  
Getting Started  
Audio & Xpdr Ctrl  
Com/Nav  
FPL  
Direct-To  
Proc  
Charts  
Wpt Info  
Map  
Traffic  
Terrain  
Weather  
Nearest  
Music  
Utilities  
System  
Messages

Message	Description	Action
<b>COM RADIO -</b> Com radio may be inoperative.	The com radio is not communicating properly with the system.	Press and hold the volume knob or the external com remote transfer (COM RMT XFR) switch, if installed – this will force the com radio to 121.5 MHz. Contact dealer for service.
<b>COM RADIO -</b> Com overtemp or undervoltage. Reducing transmitter power.	Com radio is in overtemp or undervoltage mode and transmitting power has been reduced to prevent damage to the com radio. Radio range will be reduced.	Decrease length of com transmissions, decrease cabin temperature and increase cabin airflow (especially near the GTN). Check aircraft voltage and reduce electrical load as necessary. Contact dealer for service if this message persists.
<b>COM RADIO -</b> Com locked to 121.5 MHz. Hold remote com transfer key to exit.	Com radio is locked to 121.5 MHz.	The external com remote transfer (COM RMT XFR) switch has been held and the com radio is tuned to 121.5. To exit this mode, hold the com remote transfer (COM RMT XFR) switch for two seconds.
<b>CONFIGURATION -</b> Terrain/TAWS configuration is invalid. GTN needs service.	TAWS is inoperative due to a configuration problem with the GTN. This message will be accompanied by a TER FAIL annunciation.	Contact dealer for service.
<b>CONFIGURATION MODULE -</b> GTN configuration module needs service.	The GTN cannot communicate with its configuration module. The GTN may still have a valid configuration.	Contact dealer for service.

Symbols  
Appendix

Message	Description	Action
<b>COOLING -</b> GTN overtemp. Reducing backlight brightness.	Backlight brightness has been reduced due to high display temperatures. The backlight level will remain high enough to be visible in daylight conditions.	Decrease cabin temperature and increase cabin airflow (especially near the GTN). Contact dealer for service if this message persists.
<b>COOLING FAN -</b> The cooling fan has failed.	The GTN cooling fan is powered, but it is not turning at the desired RPM.	Decrease cabin temperature and increase cabin airflow (especially near the GTN) to prevent damage to the unit. Contact dealer for service.
<b>CROSSFILL ERROR -</b> Crossfill is inoperative	Crossfill is not working due to loss of communication with other GTN or due to one GTN needing service.	See section 16.4.1.4 for a list of crossfilled items that will no longer be crossfilled. Contact dealer for service.
<b>CROSSFILL ERROR -</b> GTN software mismatch. See CRG for crossfilled items.	Crossfill is configured "on" but is not working due to software mismatch.	See section 16.4.1.4 for a list of crossfilled items that will no longer be crossfilled. Contact dealer to have software versions updated.
<b>DATABASE -</b> Chart function unavailable.	The GTN is configured for ChartView or FliteCharts and chart verification has failed.	Contact dealer for service.
<b>DATABASE -</b> Chart database valid until [DATE].	The GTN is configured for ChartView or FliteCharts and the chart database has or is about to expire.	Verify chart database expiration date on the System – System Status page. Update chart database if necessary for operations.

Foreword

Getting Started

Audio &amp; Xpdr Ctrl

Com/Nav

FPL

Direct-To

Proc

Charts

Wpt Info

Map

Traffic

Terrain

Weather

Nearest

Music

Utilities

System

Messages

Symbols

Appendix

Foreword  
Getting Started  
Audio & Xpdr Ctrl  
Com/Nav  
FPL  
Direct-To  
Proc  
Charts  
Wpt Info  
Map  
Traffic  
Terrain  
Weather  
Nearest  
Music  
Utilities  
System  
**Messages**

Message	Description	Action
<b>DATABASE -</b> A procedure has been modified in a cataloged flight plan.	A new database update caused a procedure to be truncated because the flight plan now has too many waypoints or removed a procedure because it no longer exists in the database.	Verify stored cataloged flight plans and procedures. Modify stored flight plans and procedures as necessary to include the current procedures by re-loading those procedures to the stored flight plan routes.
<b>DATABASE -</b> Verify user-modified procedures in stored flight plans are correct.	A stored flight plan contains procedures that have been manually updated, and a navigation database update has occurred.	Verify that the user-modified procedures in stored flight plans are correct.
<b>DATABASE -</b> Verify airways in stored flight plans are correct.	A stored flight plan contains an airway that is no longer consistent with the current navigation database.	Verify that the airways in stored flight plans are correct. Modify stored flight plans as necessary to include the current airways by re-loading those airways to the stored flight plan routes.
<b>DATABASE -</b> Terrain or Obstacle database not available.	The terrain or obstacle database is missing or corrupt.	Re-load these databases on the external SD card.
<b>DATA CARD ERROR -</b> SD card is invalid or failed.	External SD card has an error and the unit is not able to read the databases.	ChartView, FlightCharts, and Terrain databases will not be accessible by the unit. Contact dealer for service.
<b>DATA CARD REMOVED -</b> Reinsert SD card.	External SD card was removed.	Reinsert SD card.

Symbols  
Appendix

Message	Description	Action
<b>DATALINK -</b> GDL 69 is inoperative or connection to GTN is lost.	The GTN is configured for a Garmin datalink (GDL 69 or 69A) and the GTN cannot communicate with the datalink. Data from the datalink will not be available.	Contact dealer for service.
<b>DATA LOST -</b> Pilot stored data was lost. Recheck settings.	User settings such as map detail level, nav range ring on/off, traffic overlay on/off, and alert settings have been lost.	Recheck settings.
<b>DATA SOURCE -</b> Pressure altitude source inoperative or connection to GTN lost.	The GTN is configured to receive pressure altitude but is not receiving it from any source.	Leg types requiring an altitude source will no longer automatically sequence. Contact dealer for service.
<b>DATA SOURCE -</b> Heading source inoperative or connection to GTN lost.	The GTN is configured to receive heading information but is not receiving it from any source.	Heading up map displays will not be available. Contact dealer for service.
<b>DEMO MODE -</b> Demo mode is active. Do not use for navigation.	Demo mode is in operation.	Do not use for navigation. Power cycle the GTN to exit demo mode.
<b>FPL WAYPOINT LOCKED -</b> Stored flight plan waypoint is not in current navigation database.	A stored flight plan waypoint is no longer in the current navigation database.	Verify stored cataloged flight plans and procedures. Modify stored flight plans as necessary to include waypoints that are in the current navigation database.

Foreword

Getting Started

Audio &amp; Xpdr Ctrl

Com/Nav

FPL

Direct-To

Proc

Charts

Wpt Info

Map

Traffic

Terrain

Weather

Nearest

Music

Utilities

System

Messages

Symbols

Appendix

Foreword  
Getting Started  
Audio & Xpdr Ctrl  
Com/Nav  
FPL  
Direct-To  
Proc  
Charts  
Wpt Info  
Map  
Traffic  
Terrain  
Weather  
Nearest  
Music  
Utilities  
System  
**Messages**

Message	Description	Action
<b>FPL WPT MOVED -</b> Stored flight plan waypoint has changed location.	A stored flight plan waypoint has moved by more than 0.33 arc minutes from where previously positioned.	Verify stored cataloged flight plans and procedures. Modify stored flight plans as necessary to include waypoints that are in the current navigation database.
<b>GAD 42 -</b> GAD 42 configuration needs service.	GAD 42 indicates a configuration error.	Verify all input/output data from/to the GAD 42 Interface Adapter. Contact dealer for service.
<b>GAD 42 -</b> GAD 42 needs service.	GAD 42 indicates it needs service. The GAD 42 may continue to function.	Verify all input/output data from/to the GAD 42 Interface Adapter. Contact dealer for service.
<b>GLIDESLOPE -</b> Glideslope receiver needs service.	The glideslope board is indicating that it needs service. The glideslope board may continue to function.	Verify glideslope deviation indications with another source and crosscheck final approach fix crossing altitude. If another glideslope source is not available for verification, fly a GPS based approach. Contact dealer for service.
<b>GLIDESLOPE -</b> Glideslope receiver has failed.	The glideslope board is not communicating properly with the system.	Fly an approach that does not use the glideslope receiver (VOR, LOC, GPS). Contact dealer for service.
<b>GPS NAVIGATION LOST -</b> Insufficient satellites. Use other navigation source.	GPS position has been lost due to lack of satellites.	Use a different GPS receiver or a non-GPS based source of navigation. Contact dealer for service.

Symbols  
Appendix

Message	Description	Action
<b>GPS NAVIGATION LOST -</b> Erroneous position. Use other navigation source.	GPS position has been lost due to erroneous position.	Use a different GPS receiver or a non-GPS based source of navigation. Contact dealer for service.
<b>GPS RECEIVER -</b> GPS receiver has failed. Check GPS coax for electrical short.	Internal communication to the SBAS board is inoperative.	Use a different GPS receiver or a non-GPS based source of navigation. Contact dealer for service.
<b>GPS RECEIVER -</b> Low internal clock battery.	The GPS module indicates that its clock battery is low. The unit will function normally, but may take a longer than normal period to acquire a GPS position.	Contact dealer for service.
<b>GPS RECEIVER -</b> GPS receiver needs service.	The GPS module is reporting that it needs service. The GPS module may continue to function.	Use a different GPS receiver or a non-GPS based source of navigation. Contact dealer for service.
<b>GPS SEARCHING SKY -</b> Ensure GPS antenna has an unobstructed view of the sky.	The GPS module is acquiring position and may take longer than normal. This message normally occurs after initial installation or if the unit has not been powered for several weeks.	No action is necessary; message is informational only.

Foreword

Getting Started

Audio &amp; Xpdr Ctrl

Com/Nav

FPL

Direct-To

Proc

Charts

Wpt Info

Map

Traffic

Terrain

Weather

Nearest

Music

Utilities

System

Messages

Symbols

Appendix

Foreword  
Getting Started  
Audio & Xpdr Ctrl  
Com/Nav  
FPL  
Direct-To  
Proc  
Charts  
Wpt Info  
Map  
Traffic  
Terrain  
Weather  
Nearest  
Music  
Utilities  
System  
**Messages**

Message	Description	Action
<b>GTN -</b> GTN needs service.	The GTN has lost calibration data that was set by Garmin during manufacturing.	Contact dealer for service.
<b>INTERNAL SD CARD ERROR -</b> GTN needs service.	Internal SD card has an error. This card is not accessible by the user.	Contact dealer for service.
<b>INTERNAL SD CARD REMOVED -</b> GTN needs service.	Internal SD card was removed. This card is not accessible by the user.	Contact dealer for service.
<b>KEY STUCK -</b> HOME key is stuck.	The HOME key has been in pressed position for at least 30 seconds. This key will now be ignored.	Verify the HOME key is not pressed. Contact dealer for service if this message persists.
<b>KEY STUCK -</b> Direct-To key is stuck.	The Direct-To key has been in pressed position for at least 30 seconds. This key will now be ignored.	Verify the Direct-To key is not pressed. Contact dealer for service if this message persists.
<b>KNOB STUCK -</b> Volume knob is stuck in the pressed position.	The Volume knob has been in pressed position for at least 30 seconds. This knob press will now be ignored.	Verify the volume knob is not pressed. Contact dealer for service if this message persists.
<b>KNOB STUCK -</b> Dual concentric inner knob is stuck in the pressed position.	The dual concentric inner knob has been in pressed position for at least 30 seconds. This knob press will now be ignored.	Verify the dual concentric knob is not pressed. Contact dealer for service if this message persists.

Symbols  
Appendix



Message	Description	Action
<b>LOCKED FLIGHT PLAN</b> Cannot activate a flight plan containing a locked waypoint.	The user is trying to activate a flight plan that contains a locked waypoint.	Unlock the flight plan by modifying stored flight plans as necessary to include waypoints, procedures, and airways that are in the current navigation database.
<b>LOSS OF INTEGRITY (LOI)-</b> Verify GPS position with other navigation equipment.	The GPS module has reported a loss of integrity.	Use a different GPS receiver or a non-GPS based source of navigation. Contact dealer for service if this message persists.
<b>MAGNETIC VARIATION -</b> Aircraft in area with large mag var. Verify all course angles.	MagVar is flagged as unreliable in the MagVar database. This normally occurs when operating at high latitudes that do not support a Nav Angle of Magnetic.	Verify that the geographical region supports navigation based on magnetic variation.
<b>NAV ANGLE -</b> NAV Angles are referenced to True North (T).	Nav angle is set to True.	No action is necessary; message is informational only.
<b>NAV ANGLE -</b> NAV Angles are referenced to a User set value (U).	Nav angle is set to User.	No action is necessary; message is informational only.
<b>NON-WGS84 WAYPOINT -</b> See CRG. Location may be different than where surveyed for [WPT].	The active waypoint is not referenced to the WGS84 datum. See Note 1 at the end of the table.	No action is necessary; message is informational only.

Foreword

Getting Started

Audio &amp; Xpdr Ctrl

Com/Nav

FPL

Direct-To

Proc

Charts

Wpt Info

Map

Traffic

Terrain

Weather

Nearest

Music

Utilities

System

Messages

Symbols

Appendix

Foreword  
Getting Started  
Audio & Xpdr Ctrl  
Com/Nav  
FPL  
Direct-To  
Proc  
Charts  
Wpt Info  
Map  
Traffic  
Terrain  
Weather  
Nearest  
Music  
Utilities  
System  
Messages  
Symbols

Message	Description	Action
<b>OBS -</b> OBS is not available due to dead reckoning or no active waypoint.	OBS requires an active waypoint and is not supported in dead reckoning mode.	No action is necessary; message is informational only.
<b>PARALLEL TRACK -</b> Parallel track not supported past IAF.	Parallel track is not supported on approaches.	No action is necessary; message is informational only.
<b>PARALLEL TRACK -</b> Parallel track not supported for turns greater than 120 degrees.	Parallel track is not supported for turns greater than 120 degrees due to the acute angle.	No action is necessary; message is informational only.
<b>PARALLEL TRACK -</b> Parallel track not supported for leg type.	Parallel track is not supported on current leg type.	No action is necessary; message is informational only.
<b>REMOTE KEY STUCK -</b> Remote OBS key is stuck.	The remote OBS (OBS MODE SEL) key/switch has been in pressed position for at least 30 seconds. This input will now be ignored. This input is not available in all installations.	Verify the OBS MODE SEL key/switch is not stuck. Contact dealer for service if this message persists.
<b>REMOTE KEY STUCK -</b> Remote CDI key is stuck.	The remote CDI (CDI SRC SEL) key/switch has been in pressed position for at least 30 seconds. This input will now be ignored. This input is not available in all installations.	Verify the CDI SRC SEL key/switch is not stuck. Contact dealer for service if this message persists.

Appendix

Message	Description	Action
<b>REMOTE KEY STUCK -</b> Com push-to-talk key is stuck.	The Push To Talk key/switch has been in pressed position for at least 30 seconds. This input will now be ignored and the com radio will no longer transmit.	Verify the Push To Talk key/switch is not stuck. Contact dealer for service if this message persists.
<b>REMOTE KEY STUCK -</b> Com remote transfer key is stuck.	The remote com transfer (COM RMT XFR) key/switch has been in pressed position for at least 30 seconds. This input will now be ignored. This input is not available in all installations.	Verify the COM RMT XFR key/switch is not stuck. Contact dealer for service if this message persists.
<b>REMOTE KEY STUCK -</b> Com remote frequency increment key is stuck.	The remote com frequency increment (COM CHAN UP) key/switch has been in pressed position for at least 30 seconds. This input will now be ignored. This input is not available in all installations.	Verify the COM CHAN UP key/switch is not stuck. Contact dealer for service if this message persists.

Foreword  
Getting Started  
Audio & Xpdr Ctrl  
Com/Nav  
FPL  
Direct-To  
Proc  
Charts  
Wpt Info  
Map  
Traffic  
Terrain  
Weather  
Nearest  
Music  
Utilities  
System  
Messages

Message	Description	Action
<b>REMOTE KEY STUCK -</b> Com remote frequency decrement key is stuck.	The remote com frequency decrement (COM CHAN DN) key/switch has been in pressed position for at least 30 seconds. This input will now be ignored. This input is not available in all installations.	Verify the COM CHAN DN key/switch is not stuck. Contact dealer for service if this message persists.
<b>REMOTE KEY STUCK -</b> Nav remote transfer key is stuck.	The remote nav transfer (NAV RMT XFR) key/switch has been in pressed position for at least 30 seconds. This input will now be ignored. This input is not available in all installations.	Verify the NAV RMT XFR key/switch is not stuck. Contact dealer for service if this message persists.
<b>REMOTE KEY STUCK -</b> TAWS inhibit key is stuck.	The TAWS INHIBIT discrete input has been in pressed position for at least 30 seconds. This input will now be ignored. This input is not available in all installations.	Verify the TAWS INHIBIT key/switch is not stuck. Contact dealer for service if this message persists.
<b>SELECT FREQUENCY -</b> Select appropriate NAV frequency for approach.	Correct NAV frequency is not set in the active NAV frequency for the approach procedure.	Insert the correct frequency into the active navigation frequency window.

Symbols  
Appendix

Message	Description	Action
<b>SET COURSE -</b> Set course on CDI/ HSI to [current DTK].	The selected course on the CDI/HSI does not match the current desired track.	Set the CDI/HIS selected course to the current desired track.
<b>STEEP TURN -</b> Aircraft may overshoot course during turn.	Flight plan contains an acute course change ahead which will require a bank in excess of normal to follow the guidance. If coupled to the autopilot, the autopilot may not be able to execute the steep turn needed to follow the course guidance.	No action is necessary; message is informational only. If desired, slow the aircraft to shallow the turn.
<b>STORMSCOPE -</b> StormScope is inoperative or connection to GTN is lost.	The GTN is configured for a WX-500 StormScope but is not receiving data from it.	Contact dealer for service.
<b>STORMSCOPE -</b> Invalid heading received from StormScope.	The WX-500 StormScope reports that it has an invalid heading source.	GTN StormScope data is correct and may be used. Contact dealer for service.
<b>TAWS AUDIO INHIBITED -</b> TAWS audio inhibit input is stuck.	The TAWS Audio Inhibit discrete input has been active for at least 30 seconds. This input is active in all installations. TAWS audio may be heard at the same time as other audio alerts.	Contact dealer for service.

- Foreword
- Getting Started
- Audio & Xpdr Ctrl
- Com/Nav
- FPL
- Direct-To
- Proc
- Charts
- Wpt Info
- Map
- Traffic
- Terrain
- Weather
- Nearest
- Music
- Utilities
- System
- Messages**
- Symbols
- Appendix

Foreword  
Getting Started  
Audio & Xpdr Ctrl  
Com/Nav  
FPL  
Direct-To  
Proc  
Charts  
Wpt Info  
Map  
Traffic  
Terrain  
Weather  
Nearest  
Music  
Utilities  
System  
**Messages**

Message	Description	Action
<b>TIMER -</b> Timer has expired.	A user-configured timer has expired.	No action is necessary; message is informational only.
<b>TRAFFIC -</b> Traffic device is inoperative or connection to GTN is lost.	The GTN is configured for a traffic device but is not receiving data from it. Traffic will not be displayed on the GTN.	Contact dealer for service.
<b>TRAFFIC -</b> Traffic device has been in standby for more than 60 seconds.	The GTN is airborne and the traffic device has been in standby for more than 60 seconds.	Set the traffic device to “operate” on the traffic page if traffic alerts are desired.
<b>TRANSPONDER -</b> Transponder 1 and 2 Mode S addresses do not match.	The GTN is configured for two transponders and their Mode S addresses do not match. This message is intended to assist installers and will not occur in a properly configured system.	Contact dealer for service.
<b>TRANSPONDER 1 OR 2</b> Transponder 1 or 2 needs service.	The transponder is reporting to the GTN that it needs service. The transponder may continue to function.	Verify squawk code and altitude with ATC. Contact dealer for service.
<b>TRANSPONDER 1 OR 2</b> Transponder 1 or 2 is inoperative or connection to GTN is lost.	The GTN is configured for transponder 1 or 2 but is not able to communicate with the transponder.	Verify squawk code and altitude with ATC. Contact dealer for service.

Symbols  
Appendix

Message	Description	Action
<b>TRUE NORTH APPROACH -</b> Verify NAV Angles are referenced to True North (T).	A procedure is loaded that is referenced to true north and the active leg has a published true north reference.	Verify the Nav Angle is set to True North.
<b>VERTICAL CALCULATOR -</b> Approaching target altitude. Start descent.	User has configured a vertical descent calculation, and the aircraft is within 60 seconds of the calculated top of descent.	No action is necessary; message is informational only.
<b>VERTICAL CALCULATOR -</b> Approaching target altitude.	User has configured a vertical descent calculation, and the aircraft is approaching the target altitude.	No action is necessary; message is informational only.
<b>VLOC RECEIVER -</b> Navigation receiver needs service.	The nav radio is reporting that it needs service. The nav radio may continue to function.	Use GPS based navigation. Contact dealer for service.
<b>VLOC RECEIVER -</b> Navigation receiver has failed.	The nav radio is not communicating properly with the system.	Use GPS based navigation. Contact dealer for service.
<b>WAYPOINT -</b> Arriving at [wpt name].	User has configured the arrival alarm and is within the specified distance.	No action is necessary; message is informational only.

**Table 17-1 Messages**

Foreword

Getting Started

Audio & Xpdr Ctrl

Com/Nav

FPL

Direct-To

Proc

Charts

Wpt Info

Map

Traffic

Terrain

Weather

Nearest

Music

Utilities

System

Messages

Symbols

Appendix

**Note 1:**

There are several reference datums that waypoints can be surveyed against. TSO-C146 normally requires that all waypoints be referenced to the WGS84 datum, but allows for navigation to waypoints that are not referenced to the WGS84 datum so long as the pilot is notified. Certain waypoints in the navigation database are not referenced to the WGS84 datum, or their reference datum is unknown. If this is the case, this message is displayed. Garmin cannot determine exactly how close the non-WGS84 referenced waypoint will be to the WGS84 datum that the GTN uses. Typically, the distance is within two nautical miles. The majority of non-WGS84 waypoints are located outside of the United States.

Foreword

Getting Started

Audio &amp; Xpdr Ctrl

Com/Nav

FPL

Direct-To

Proc

Charts

Wpt Info

Map

Traffic

Terrain

Weather

Nearest

Music

Utilities

System

Messages

Symbols

Appendix



# 18 SYMBOLS

The following tables describe the symbols that are found on the Map display.

## 18.1 Map Page Symbols

Symbol	Description
	Unknown Airport
	Non-towered, Non-serviced Airport
	Towered, Non-serviced Airport
	Non-towered, Serviced Airport
	Towered, Serviced Airport
	Soft Surface, Serviced Airport
	Soft Surface, Non-serviced Airport
	Private Airport
	Heliport
	Intersection
	LOM (compass locator at outer marker)
	NDB (Non-directional Radio Beacon)
	VOR
	VOR/DME
	ILS/DME or DME-only
	VORTAC
	TACAN

**Table 18-1 Map Page Symbols**

Foreword

Getting Started

Audio & Xpdr Ctrl

Com/Nav

FPL

Direct-To

Proc

Charts

Wpt Info

Map

Traffic

Terrain

Weather

Nearest

Music

Utilities

System

Messages

Symbols

Appendix

## 18.2 SafeTaxi™ Symbols





Symbol	Description
	Helipad
	Airport Beacon
	Under Construction Zones
	Unpaved Parking Areas

Table 18-2 SafeTaxi Symbols

## 18.3 Traffic Symbols





Symbol	Description (Highest to Lowest Priority)
	Traffic Advisory (TA), In Range
	Traffic Advisory (TA), Out of Range
	Proximate Advisory (PA)
	Other Traffic

Table 18-3 Traffic Symbols

# 18.4 Terrain Obstacle Symbols

Unlighted Obstacle (Height is less than 1000 ft AGL)	Lighted Obstacle (Height is less than 1000 ft AGL)	Unlighted Obstacle (Height is greater than 1000 ft AGL)	Lighted Obstacle (Height is greater than 1000 ft AGL)

**Figure 18-1 Obstacle Altitude/Color Correlation**

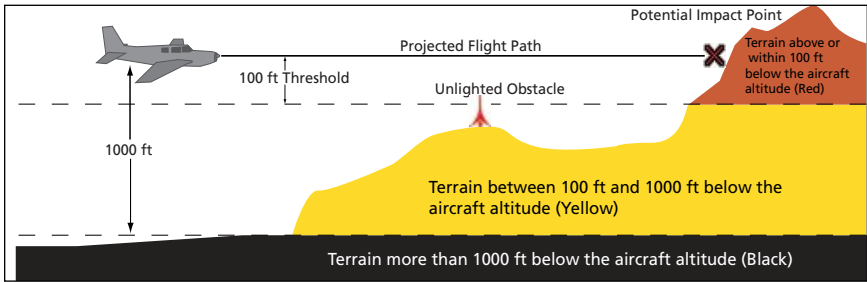

**Figure 18-2 TERRAIN Altitude/Color Correlation**

- Foreword
- Getting Started
- Audio & Xpdr Ctrl
- Com/Nav
- FPL
- Direct-To
- Proc
- Charts
- Wpt Info
- Map
- Traffic
- Terrain
- Weather
- Nearest
- Music
- Utilities
- System
- Messages
- Symbols**
- Appendix

## 18.5 Basemap Symbols

Symbol	Description
	Interstate Highway
	State Highway
	US Highway
	National Highway - 2-digit drawn inside
	Small City or Town
	Medium City
	Large City

Table 18-4 Basemap Symbols

## 18.6 Map Tool Bar Symbols





Symbol	Description
	Terrain Proximity Enabled and Available Indicator
	Terrain Proximity Enabled and Not Available Indicator
	StormScope Enabled
	Traffic Enabled and Available Indicator
	Traffic Enabled and Not Available Indicator

Table 18-5 Map Tool Bar Symbols

Foreword

Getting Started

Audio & Xpdr Ctrl

Com/Nav

FPL

Direct-To

Proc

Charts

Wpt Info

Map

Traffic

Terrain

Weather

Nearest

Music

Utilities













System

Messages

Symbols

Appendix

# 18.7 Miscellaneous Symbols

Symbol	Description
	Default Aircraft (ownership)
	High Wing Aircraft
	Jet Aircraft
	Non-directional ownership is shown if there is no heading or ground track. This typically only occurs during start-up.
	Parallel Track Waypoint
	Restricted/Prohibited/Warning/Alert
	TFR (Temporary Flight Restrictions)
	MOA
	Class B Airspace
	Class C Airspace
	Class D Airspace
	User Waypoint

**Table 18-6 Miscellaneous Symbols**

Foreword

Getting Started

Audio & Xpdr Ctrl

Com/Nav

FPL

Direct-To

Proc

Charts

Wpt Info

Map

Traffic

Terrain

Weather

Nearest

Music

Utilities

System

Messages

**Symbols**

Appendix

Foreword

Getting  
Started

Audio &  
Xpdr Ctrl

Com/Nav

FPL

Direct-To

Proc

Charts

Wpt Info

Map

*This page intentionally left blank*

Traffic

Terrain

Weather

Nearest

Music

Utilities

System

Messages

Symbols

Appendix

# 19 APPENDIX

## 19.1 Glossary

ACT, ACTV	active, activate	
ADC	Air Data Computer	
ADF	Automatic Direction Finder	
ADI	Attitude Direction Indicator	
AFM	Airplane Flight Manual	
AFMS	Airplane Flight Manual Supplement	
AGL	Above Ground Level	
AIM	Airman's Information Manual	
AIRMET	Airman's Meteorological Information	
ALT	altitude	
AP	autopilot	
APR	approach	
APT	airport, aerodrome	
ARINC	Aeronautical Radio Incorporated	
ARSPC	airspace	
ARTCC	Air Route Traffic Control Center	
AS	airspeed	
ASOS	Automated Surface Observing System	
ATC	Air Traffic Control	
ATCRBS	ATC Radar Beacon System	
ATIS	Automatic Terminal Information Service	
AUX	auxiliary	
AWOS	Automated Weather Observing System	
BARO	barometric setting	
BC	backcourse	
Bearing	The compass direction from the present position to a destination waypoint	
BRG	bearing	
C	center runway	
°C	degrees Celsius	
CDI	Course Deviation Indicator	
CHNL	channel	
CLD	cloud	

Foreword

Getting Started

Audio &amp; Xpdr Ctrl

Com/Nav

FPL

Direct-To

Proc

Charts

Wpt Info

Map

Traffic

Terrain

Weather

Nearest

Music

Utilities

System

Messages

Symbols

Appendix

Foreword	CLR	clear
	CONFIG	configuration
Getting Started	Course	The line between two points to be followed by the aircraft
Audio & Xpdr Ctrl	Crosstrack Error	The distance the aircraft is off a desired course in either direction, left or right
Com/Nav	CRS	course
	CRSR	cursor
FPL	CTA	Control Area
	CTAF	Common Traffic Advisory Frequency
Direct-To	CTRL	control
	CUM	The total of all legs in a flight plan
Proc		
Charts	DALT	density altitude
	DB, DBASE	database
Wpt Info	DCLTR, DECLTR	declutter
	deg	degree
Map	DEP	departure
	Desired Track (DTK)	The desired course between the active “from” and “to” waypoints
Traffic	DEST	destination
	DFLT	default
Terrain	DIS	distance
	Distance	The “great circle” distance from the present position to a destination waypoint
Weather	DME	Distance Measuring Equipment
Nearest	DP	Departure Procedure
	DPRT	departure
Music	DSBL	disabled
	DTK	Desired Track
Utilities		
System	EDR	Excessive Descent Rate
	EGNOS	Provides SBAS service for most of Europe and parts of North Africa
Messages	ELEV	elevation
Symbols	EMI	Electromagnetic Interference
	ENR	en route

**Appendix**



En Route Safe Altitude	The recommended minimum altitude within ten miles left or right of the desired course on an active flight plan or direct-to	Foreword
ERR	error	Getting Started
ESA	En route Safe Altitude	Audio & Xpdr Ctrl
ETA	Estimated Time of Arrival	
ETE	Estimated Time En Route	Com/Nav
°F	degrees Fahrenheit	FPL
FAA	Federal Aviation Administration	
FCC	Federal Communication Commission	Direct-To
FCST	forecast	
FD	flight director	Proc
FIR	Flight Information Region	
FIS-B	Flight Information Services-Broadcast	Charts
FISDL	Flight Information Service Data Link	
FLTA	Forward Looking Terrain Avoidance	Wpt Info
FPL	flight plan	
FREQ	frequency	Map
FRZ	freezing	
FSS	Flight Service Station	Traffic
ft	foot/feet	Terrain
G/S, GS	glideslope	Weather
GDC	Garmin Air Data Computer	
GDL	Garmin Satellite Data Link	Nearest
GEO	geographic	
GLS	Global Navigation Satellite Landing System	Music
GMA	Garmin Audio Panel System	
GMT	Greenwich Mean Time	Utilities
GMU	Garmin Magnetometer Unit	
GPS	Global Positioning System	System
GPSS	GPS Roll Steering	
Ground Speed	The velocity that the aircraft is travelling relative to a ground position	Messages
Ground Track	see <i>Track</i>	
GRS	Garmin Reference System	Symbols
GS	Ground Speed	
GTX	Garmin Transponder	Appendix

Foreword	HDG	heading
Getting Started	Heading	The direction an aircraft is pointed, based upon indications from a magnetic compass or a properly set directional gyro
Audio & Xpdr Ctrl	HFOM	Horizontal Figure of Merit
	Hg	mercury
Com/Nav	hPa	hectopascal
	HPL	Horizontal Protection Level
FPL	HSDB	High-Speed Data Bus
	HSI	Horizontal Situation Indicator
Direct-To	Hz	Hertz
Proc	IAF	Initial Approach Fix
Charts	ICAO	International Civil Aviation Organization
	IFR	Instrument Flight Rules
Wpt Info	IGRF	International Geomagnetic Reference Field
	ILS	Instrument Landing System
Map	IMC	Instrument Meteorological Conditions
	IOI	Imminent Obstacle Impact
Traffic	INFO	information
	in HG	inches of mercury
Terrain	INT	intersection(s)
	INTEG	integrity (RAIM unavailable)
Weather	ITI	Imminent Terrain Impact
Nearest	L	left, left runway
	LAT	latitude
Music	LCD	Liquid Crystal Display
	LCL	local
Utilities	LED	Light Emitting Diode
	Leg	The portion of a flight plan between two waypoints
System	LIFR	Low Instrument Flight Rules
	LNAV	Lateral Navigation
Messages	LOC	localizer
	LOI	loss of integrity (GPS)
Symbols	LON	longitude
	LPV	Localizer Performance with Vertical guidance
Appendix	LRU	Line Replacement Unit
	LT	left

LTNG	lightning	Foreword
MAG	Magnetic	Getting Started
MAG VAR	Magnetic Variation	Audio & Xpdr Ctrl
MapMX	A proprietary data format used to forward navigation information between Garmin units	Com/Nav
MAX	maximum	FPL
MAXSPD	maximum speed (overspeed)	Direct-To
MDA	barometric minimum descent altitude	Proc
METAR	Aviation Routine Weather Report	Charts
MIN	minimum	Wpt Info
Minimum Safe Altitude	Uses Grid MORAs to determine a safe altitude within ten miles of the aircraft present position	Map
MKR	marker beacon	Traffic
MOA	Military Operations Area	Terrain
MOV	movement	Weather
mpm	meters per minute	Nearest
MSA	Minimum Safe Altitude	Music
MSAS	Provides SBAS service for Japan only	Utilities
MSG	message	System
MSL	Mean Sea Level	Messages
MT	meter	Symbols
mV	millivolt(s)	Appendix
MVFR	Marginal Visual Flight Rules	
NAV	navigation	
NAVAID	NAVigation AID	
NCR	Negative Climb Rate	
NDB	Non-Directional Beacon	
NEXRAD	Next Generation Radar	
OAT	Outside Air Temperature	
OBS	Omni Bearing Selector	
PA	Proximity Advisory	
PC	personal computer	
PDA	Premature Descent Alert	

Foreword	P. POS	Present Position
Getting Started	PTK	parallel track
Audio & Xpdr Ctrl	QTY	quantity
Com/Nav	R	right, right runway
FPL	RAIM	Receiver Autonomous Integrity Monitoring
	RAM	random access memory
Direct-To	REF	reference
	REQ	required
Proc	REV	reverse, revision, revise
	RMI	Radio Magnetic Indicator
Charts	RNG	range
	RNWX	runway
Wpt Info	ROC	Reduced Required Obstacle Clearance
	RT	right
Map	RTC	Reduced Required Terrain Clearance
Traffic	SBAS	Satellite-Based Augmentation System
Terrain	SCIT	Storm Cell Identification and Tracking
	SD	Secure Digital
	SFC	surface
Weather	SIAP	Standard Instrument Approach Procedures
	SID	Standard Instrument Departure
Nearest	SIGMET	Significant Meteorological Information
	SLP/SKD	slip/skid
Music	SMBL	symbol
	SPD	speed
Utilities	SRVC, SVC	service
	STAR	Standard Terminal Arrival Route
System	STATS	statistics
	STBY	standby
Messages	STD	standard
	SUA	Special Use Airspace
Symbols	SUSP	suspend
	SW	software
Appendix	SYS	system

T	true	
TA	Traffic Advisory	Foreword
TACAN	Tactical Air Navigation System	
TAF	Terminal Aerodrome Forecast	Getting Started
TAS	True Airspeed	
TAS	Traffic Advisory System	Audio & Xpdr Ctrl
TAT	Total Air Temperature	
TAWS	Terrain Awareness and Warning System	Com/Nav
TCA	Terminal Control Area	
TCAS	Traffic Collision Avoidance System	FPL
TEMP	temperature	
TERM	terminal	Direct-To
TFR	Temporary Flight Restriction	
T HDG	True Heading	Proc
TIS	Traffic Information System	
TMA	Terminal Maneuvering Area	Charts
Topo	topographic	
Track	Direction of aircraft movement relative to a ground position; also 'Ground Track'	Wpt Info
TRK	track	Map
TRSA	Terminal Radar Service Area	Traffic
UNAVAIL	unavailable	Terrain
USR	user	
UTC	Coordinated Universal Time	Weather
UTM/UPS	Universal Transverse Mercator/ Universal Stereographic Grid	Polar Nearest
V, Vspeed	velocity (airspeed)	Music
VAR	variation	
VFR	Visual Flight Rules	Utilities
VHF	Very High Frequency	
VLOC	VOR/Localizer Receiver	System
VMC	Visual Meteorological Conditions	
VNAV, VNV	vertical navigation	Messages
VOR	VHF Omni-directional Range	
VORTAC	very high frequency omnidirectional range station and tactical air navigation	Symbols
VS	Vertical speed	Appendix

Foreword	VSI	Vertical Speed Indicator
Getting Started		
Audio & Xpdr Ctrl	WAAS	Wide Area Augmentation System
	WGS-84	World Geodetic System - 1984
	WPT	waypoint(s)
Com/Nav	WX	weather

FPL	XPDR	transponder
Direct-To	XTK	cross-track

Proc

Charts

Wpt Info

Map

Traffic

Terrain

Weather

Nearest

Music

Utilities

System

Messages

Symbols

Appendix

Index

## 19.2 SD Card Use and Databases

The GTN 7XX System uses Secure Digital (SD) cards to load and store various types of data. For basic flight operations, SD cards are required for database storage as well as database updates.

### 19.2.1 Jeppesen Databases

The navigation database is updated on a 28-day cycle. Navigation database updates are provided by Garmin and may be downloaded from the Garmin web site “fly.garmin.com” onto a Garmin provided Supplemental Data card. Contact Garmin at fly.garmin.com for navigation database updates and update kits. The Navigation database is stored internally and the data card is only used to transfer the database into the unit.

The optional ChartView database is updated on a 14 day cycle. The ChartView database is provided directly from Jeppesen. Contact Jeppesen (www.jeppesen.com) for ChartView subscription and update information. An enablement card that is purchased from Garmin is separate from the Jeppesen database and is required to enable ChartView.



---

**NOTE:** *Garmin requests that the flight crew report any observed discrepancies related to database information. These discrepancies could come in the form of an incorrect procedure, incorrectly identified terrain, obstacles and fixes, or any other displayed item used for navigation or communication in the air or on the ground. Go to “FlyGarmin.com” and at the bottom of the page select “Aviation Data Error Report.”*

---

#### Updating the Jeppesen navigation database

1. With the GTN 7XX System OFF, insert the SD card containing the navigation database update into the card slot of the GTN 7XX to be updated (label of SD card should face to the right).
2. Turn the GTN 7XX System ON.
3. Verify the correct update cycle is loaded during power-up.

## 19.2.2 Garmin Databases



**NOTE:** The data contained in the terrain and obstacle databases comes from government agencies. Garmin accurately processes and cross-validates the data, but cannot guarantee the accuracy and completeness of the data.

The Supplemental Data Card should not be removed except to update the databases stored on the card. The data cards cannot be moved between units.



Figure 19-1 SD Card Database Location

The Garmin databases can be updated by following the instructions on [fly.garmin.com](http://fly.garmin.com). Once the updated files have been downloaded from the web site, a PC equipped with an appropriate SD card reader is used to unpack and program the new databases onto the existing Supplemental Data Cards. The following equipment is required to perform the update:

- Windows-compatible PC computer (Windows 2000, XP, Vista, or Windows 7 recommended)
- SanDisk SD Card Reader, P/Ns SDDR-93 or SDDR-99 or equivalent card reader
- Updated database obtained from the Garmin web site
- Existing Garmin Supplemental Database SD Card

It may be necessary to have the system configured by a Garmin authorized



service facility in order to use certain database features.

## Common Problems/Troubleshooting Tips for Databases

- SD Cards
  - The supplied SD cards, and most commercially available SD cards, have a small sliding tab located on the top left of the card (when viewing the card label-side up).
  - When the sliding tab is in the Down position (as in farther away from the gold contacts on the back of the card), you will not be able to write data to the card, as it will be write protected.
  - The tab must be in the Up position to work correctly.
- Card Programmer
  - If a card programmer is having trouble finding or writing data to the SD cards, you may have to upgrade to a High Capacity SD card programmer.
  - SD cards with a capacity of 4GB are considered high capacity.
  - Most non-high capacity card programmers will not work with a high capacity SD card. High capacity card programmers can be easily purchased at a consumer electronics store.
  - Ensure that your card programmer is not plugged into a USB hub, your computer screen, or your keyboard.
  - Make sure it is plugged directly into your computer (the back of the computer, if using a desktop computer).
- If you accidentally place a file onto the wrong card, call Garmin's Aviation Product Support team to look at the files and delete the proper files.
  - Do not format the cards

Foreword

Getting Started

Audio & Xpdr Ctrl

Com/Nav

FPL

Direct-To

Proc

Charts

Wpt Info

Map

Traffic

Terrain

Weather

Nearest

Music

Utilities

System

Messages

Symbols

Appendix

## Updating Garmin Databases

1. Download the data to the data cards from the appropriate web site.
2. Insert Navigation Database SD card in the slot of the GTN 7XX.
3. Apply power to the GTN 7XX System. View the power-up splash screen. Check that the databases are initialized and displayed on the splash screen. Some databases can take up to 15 minutes to update.
4. The database update page will prompt to either Update or Continue. Touch the **Update** key to update the database(s). Touch the **Continue** key to continue to normal operation without updating a database. This process will repeat for each database that is available on the card for updating.
5. After the database(s) have completed the update process, touch **OK** to continue the normal progression of start-up displays.
6. From the Home page, touch the **System** key. Then, touch the **System Status** key.
7. Check that all databases are current and there are no errors. If a database is highlighted in yellow, it is either expired or the GTN 7XX can not determine the date.

- Foreword
- Getting Started
- Audio & Xpdr Ctrl
- Com/Nav
- FPL
- Direct-To
- Proc
- Charts
- Wpt Info
- Map
- Traffic
- Terrain
- Weather
- Nearest
- Music
- Utilities
- System
- Messages
- Symbols
- Appendix
- Index

## 19.3 Demo Mode

The GTN product contains a “Demo” mode that allows simulation of all operations of the product to allow practice and familiarization while staying on the ground.



**WARNING:** Do not use the GTN to navigate while Demo mode is active. Do not use or enter Demo mode while airborne.



1. Press in and hold the **Direct-To** key and then apply power to the unit.

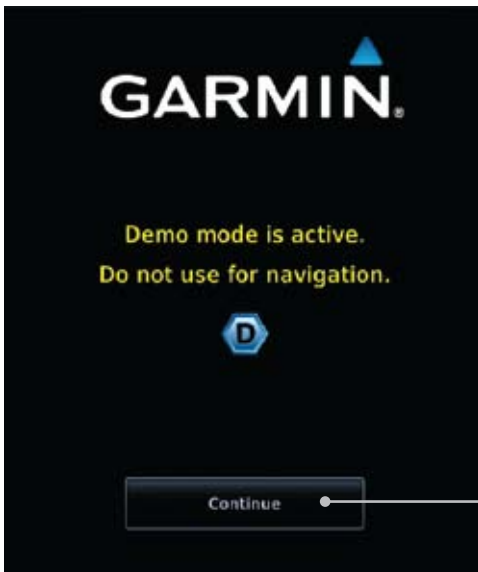

Figure 19-2 Demo Mode Start Up Display



2. Touch the **Continue** key and Fuel keys as normally needed to start operations.



3. Touch the **Demo** key in the lower part of the display to reach the Demo Setup functions.



*Touch For GPS Settings*

*Touch For NAV Settings*

*Touch For Date  
And Time Settings*

**Figure 19-3 Demo Mode Setup**



4. Touch the **GPS** key to reach the Demo GPS Settings page. The Position Error values (Horizontal Protection Level Fault Detection [HPL FD], HPL SBAS, and Vertical Protection Level [VPL] SBAS) may be adjusted to reflect errors induced by naturally occurring conditions, but are normally not adjusted for most Demo mode operations.



*Touch To Select GPS  
Solution*

*Touch To Select Lat/  
Lon Coordinates For  
Current Position*

*Touch To Select  
HPL FD Values, If  
Desired*

*Touch For GPL  
SBAS Settings*

*Touch To Select  
Current Position  
From A Wpt In  
The Database*

*Touch For VPL  
SBAS Settings*

**Figure 19-4 Demo Mode GPS Settings**



5. Touch the **Nav** key to reach the Demo Navigation Settings page.

Touch To Select Vertical Speed

Touch To Select Airspeed

Touch To Select Track Mode

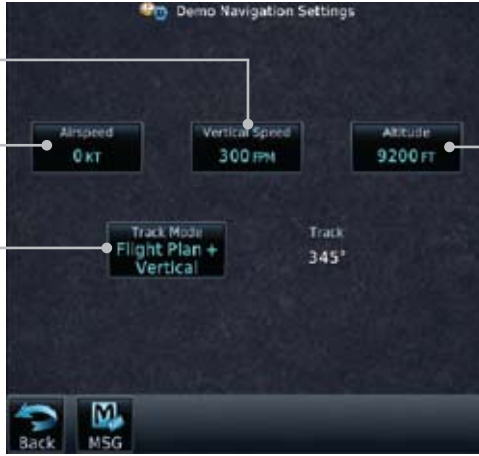

Touch To Select Altitude

Figure 19-5 Demo Mode Navigation Settings



6. Touch the **Date/Time** key to reach the Demo Date/Time Settings page.

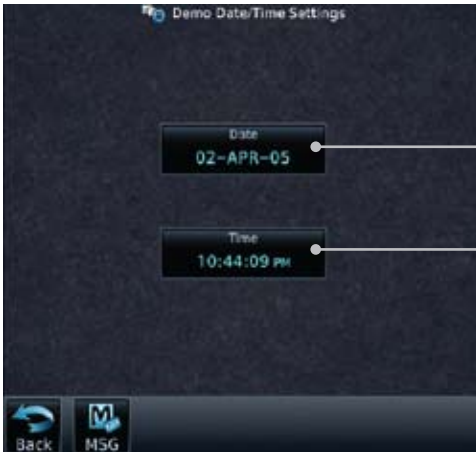

Touch To Set Date

Touch To Set Time

Figure 19-6 Demo Mode Date/Time Settings



7. After completing the settings for Demo mode, touch the **HOME** key or **Back** key to get started with operating the GTN.

## 19.4 Glove Qualification Procedure

This procedure is used to qualify a specific glove for use with the GTN system by guiding the user through a variety of tasks that use the touchscreen. Due to differences in finger size, glove size, and touchscreens between the 6XX or 7XX unit, the qualification granted by this procedure is specific to the pilot/glove and 6XX or 7XX combination. GTN 7XX and 6XX units must be evaluated separately.

The GTN touchscreen uses capacitive touch technology to sense the proximity of skin to the display. A glove increases the distance between skin and the display glass and may reduce the ability of the GTN to detect touches. Therefore, when selecting a glove for use with the GTN, thinner gloves tend to work better than thicker gloves. Leather gloves and gloves designed to work specifically with capacitive touchscreen devices are often found to be acceptable. Additionally, altering your touch technique to use the pad of your finger to touch the unit rather than the tip will increase the touchscreen sensitivity while using gloves.

This qualification must be completed on the ground. Performing this procedure in flight is not authorized. Table 19-1 contains tasks that are required to qualify a glove. Table 19-2 contains tasks that are not required to qualify a glove, but may limit the manner in which some functions are accessed while a glove is worn.

1. Sit in the pilot's seat.
2. Start the GTN in Demo mode by pressing and holding the **Direct To** key during power up.
3. Perform the tasks listed in Table 19-1 and Table 19-2 with an ungloved hand. You do not need to record any results for this step.
4. Perform the tasks listed in Table 19-1 and Table 19-2 with a gloved hand. For each task, determine whether the operation is the same or worse as it was without the glove. Record the results in Table 19-1 and Table 19-2. Items that may cause the operation to be worse include, but are not limited to:
  - a. Multiple attempts to select a key
  - b. Unintentional selection of adjacent keys
  - c. Excessive force on the touchscreen to select a key
5. If all applicable tasks in Table 19-1 respond in the same way with and without a glove then the glove used to complete these tasks may be used by the pilot

who performed this evaluation on the unit (6XX or 7XX) that was used during this procedure.

Pilot: \_\_\_\_\_

Glove Description: \_\_\_\_\_

GTN (circle one): 6XX or 7XX

Task	Operation With Glove (circle one)	
Navigate to the Home Screen.	NA	
Touch the <b>Demo</b> key.	Same	Worse
Touch the <b>GPS</b> key.	Same	Worse
Touch the <b>Waypoint</b> key.	Same	Worse
Type "KSLE" using the touchscreen, then touch <b>Enter</b> .	Same	Worse
Navigate to the Home Screen (Press <b>HOME</b> ).	NA	
Touch the <b>Flight Plan</b> key.	Same	Worse
Enter the following waypoints using the <b>Add Waypoint</b> key at the bottom of the list of flight plan waypoints: KSLE KMMV KONP BTG	Same	Worse
Select BTG, then touch the <b>Load Airway</b> key to load the following airway: V23 ALFOR.	Same	Worse
While viewing the flight plan page, touch the <b>Up/Down</b> arrow keys to scroll up and down to view the flight plan waypoints.	Same	Worse
Touch the <b>Back</b> key to return to the Home screen.	Same	Worse
Touch the COM standby frequency to activate the com frequency entry keypad (Task applicable to 635/650/750 only).	Same	Worse
Enter a valid com frequency and touch the <b>Enter</b> key (635/650/750 only).	Same	Worse

Foreword  
Getting Started  
Audio & Xpdr Ctrl  
Com/Nav  
FPL  
Direct-To  
Proc  
Charts  
Wpt Info  
Map  
Traffic  
Terrain  
Weather  
Nearest  
Music  
Utilities  
System  
Messages  
Symbols  
Appendix  
Index

Task	Operation With Glove (circle one)	
Touch the active com frequency to flip/flop the com frequencies. (635/650/750 only).	Same	Worse
Touch the active nav frequency to flip/flop the nav frequencies (750 only).	Same	Worse
Touch the <b>Menu</b> key (650 only).	Same	Worse

**Table 19-1 Tests Required for Glove Qualification**

Task	Operation With Glove (circle one)	
Navigate to the flight plan page.	NA	
While viewing the flight plan page, touch the list and drag up/down to view the flight plan waypoints.	Same	Worse
While viewing the flight plan page, touch and flick the list to view the flight plan waypoints.	Same	Worse
Navigate to the map page.	NA	
Touch the Map to enter Pan mode, then touch the <b>Graphically Edit FPL</b> key.	Same	Worse
Remove KONP from the flight plan graphically by touching KONP and dragging it to an area without any waypoints (Pan and zoom in/out as necessary to accomplish the task).	Same	Worse
Insert KSPB between KMMV and BTG by dragging the leg between KMMV and BTG to KSPB.	Same	Worse

**Table 19-2 Tests Not Required for Glove Qualification**



# INDEX

## Symbols

3D navigation 16-9

## A

Abbreviations 8-14  
 About this guide xvii  
 Above Ground Level 11-8  
 Acquiring satellites 16-7, 16-9  
 Activate flight plan 4-24  
 Activate leg 4-6  
 Activating XM 14-2  
 Active flight plan page 4-4  
 Active leg 4-6, 6-14, 6-15, 6-18  
 Add User frequency 3-9  
 ADF 19-1  
 ADIZ 9-24  
 Age 12-7  
 Aircraft symbol 9-1, 18-5  
 AIREP 12-27  
 AIRMETs 12-7, 12-16  
 Airport beacon 18-2  
 Airport diagram 7-14, 16-4  
 Airport frequencies 8-8  
 Airspace 13-10  
 Airspace altitude buffer 16-21  
 Airways 4-12, 9-5, 9-19, 9-24  
 Alerts 1-13, 10-7, 11-1, 11-12, 11-13,  
 11-15, 11-19, 16-20  
 ALT 15-27  
 Altimeter ii, 11-7  
 Altitude 6-14, 11-1, 16-7, 16-8  
 Altitude buffer 16-20  
 Altitude Display Mode 10-4, 10-13  
 Altitude reporting 2-3  
 Altitude type 15-5  
 Annunciations 1-6, 1-19, 6-2, 10-8, 10-9,  
 10-14, 10-15, 11-6, 11-12, 11-19  
 Approach  
 Channel 6-12  
 Approaches 7-2, 7-14, 11-16, 19-1  
 Select 1-18

Approach operations 6-2  
 Approach with hold 6-14  
 Arc 11-4, 11-10, 11-11  
 Arrivals 7-14  
 ARTCC 13-1, 13-13  
 ASOS 13-17  
 ATCRBS 10-5  
 ATIS 13-17  
 Attitude 19-1  
 Audio panel 2-6  
 Audio split mode 2-12  
 Aural message 11-8, 11-12, 11-14,  
 11-17, 11-19  
 Automatic CDI switching 6-19  
 Autopilot 6-13, 6-17, 6-18, 6-19, 6-20  
 Auto-pilot output 6-20  
 Auto zoom 9-13  
 AUX - System Status Page 16-3  
 Aviation map data 9-18  
 AWOS 13-17

## B

Backcourse 6-19  
 Backlighting 16-28  
 Baro-corrected altitude 11-7  
 Barometric pressure 15-27  
 Basemap 16-5  
 Basemap symbols 18-4  
 Basic approach operation 6-2  
 Beacon 18-1, 18-2

## C

Catalog 4-2  
 Category 14-4  
 Cautions iii, 9-24, 11-8, 11-9, 11-13  
 CDI 9-33  
 Ceiling 13-12  
 Cell movement 9-21, 12-7, 12-15  
 Change data fields 9-21  
 Channel 14-1, 14-4, 14-7  
 Channel spacing 1-12  
 Chart airport info 7-8  
 Chart airport selection 7-3  
 Chart Color Scheme 9-17

Foreword  
 Getting Started  
 Audio & Xpdr Ctr  
 Com/Nav  
 FPL  
 Direct-To  
 Proc  
 Charts  
 Wpt Info  
 Map  
 Traffic  
 Terrain  
 Weather  
 Nearest  
 Music  
 Utilities  
 System  
 Messages  
 Symbols  
 Appendix

Foreword Chart detail  
 Approaches 7-5  
 Arrivals 7-7  
 Departures 7-6  
 Information 7-4

Getting Started Chart full-split screen 7-9  
 Chart info 7-4

Audio & Xpdr Ctrl Chart invert colors 7-13  
 Chart layers 7-11

Com/Nav FPL All 7-11  
 Header 7-11

Direct-To Minimums 7-12  
 Plan 7-11  
 Profile 7-12

Proc Charts 7-1, 7-14, 9-7  
 ChartView 1-3, 7-1, 8-10, 16-5, 19-9  
 ChartView database 1-3, 7-13, 16-5, 19-9  
 ChartView subscription 7-14, 16-5, 19-9

Wpt Info City 9-24, 12-7  
 City forecast 12-7, 12-22

Map Class B airspace 9-24, 18-5  
 Class C airspace 9-24, 18-5

Traffic Class D airspace 9-24, 18-5  
 Cloud tops 12-7, 12-14

Terrain Cloudy 12-8  
 Com 1-16, 3-1  
 Channel spacing 1-12, 16-16

Weather Frequency monitoring 3-14  
 Tuning 3-3

Nearest Window 3-3  
 Controlled airspace 9-35, 13-10

Music Controls 1-4  
 Conventions 1-2

Utilities Copy flight plan 4-26  
 County warnings 12-7, 12-17

System Creating a flight plan 1-17, 4-2  
 Creating user waypoints 8-16, 9-28  
 Crossfill 1-12, 1-14, 16-18

Messages CTAF 8-8  
 Customizing maps 9-10

Symbols Cycle number 1-6, 7-15, 7-17  
 Cyclone 12-7, 12-20

Appendix

## D

Database 1-4, 3-5, 3-17, 7-15, 7-17,  
 11-1, 11-2, 11-19, 16-3, 16-4,  
 19-9, 19-10

Databases 1-6

Database verification 1-7

Data card 1-3

Data link 10-1, 12-1, 12-7

Data Link Receiver troubleshooting 14-8

Date 7-13, 7-15, 7-17, 15-11, 15-12,  
 16-4, 16-15

Date/Time 19-15

DCLTR soft key 9-23

Dead reckoning 1-19

Declutter 9-20

Delete flight plan 4-27, 4-28

Demo mode 19-13

Density altitude 15-27

Departures 7-14, 11-16

Departure time 15-10

Destination proximity 16-21

Direct-To 1-5, 1-15, 5-1

Direct-To Fpl Wpt 5-3

Direct-To Nrst Airport 5-4

Distance 9-13

DME 18-1

DME Arc 6-15

Don't sink 11-14, 11-17

DP 7-14

Dual installation 1-14

## E

Echo tops 12-7, 12-13

Edit flight plan 4-25, 9-29

Edit FPL data fields 4-21

EGNOS 16-10

Emergency frequency 3-12

Enablement card 7-1, 7-13, 19-9

ENR 6-3

EPU 16-7, 16-9

Excessive descent rate alert 11-14, 11-15

Expiration time 12-3, 12-7

## F

Facility name 13-13, 13-15, 13-17  
FDE 16-9  
Find Com frequency 3-5  
FIR 13-1  
Five-hundred aural alert 11-14  
Flight phase 11-16  
Flight plan 1-17, 4-1, 9-13, 15-18, 15-25  
Flight plan frequency 3-9  
Flight plan menu 4-16  
Flight timers 15-10  
FliteCharts 7-14, 7-15, 16-5  
FliteCharts database 7-14  
Flood 12-8  
Fog 12-8  
Forward looking terrain avoidance 11-15  
Freezing level 12-7, 12-18

### Frequency

- Flight plan 3-9
- Monitoring 3-14
- Nearest 3-6
- New user 3-9
- Recent 3-6

Frequency finding 3-5, 3-17

FSS 13-1, 13-15

Fuel planning 15-21

Fuel settings 1-7, 16-22

## G

GDC 74A ii

GDL 69/69A iii, 9-21, 14-1, 14-2, 14-8,  
16-12

GDL 69/69A status 16-12

GDL 69 troubleshooting 14-8

Getting started 1-1

Glideslope 3-15

Glossary 19-1

GMT 16-15

GPS 19-14

GPS altitude ii, 11-1, 11-7

GPS status 16-7

Ground 2-3

Ground speed 11-19

GSL 11-1, 11-7

GTN 725 1-1

GTN 750 1-2

## H

Hail 12-10, 12-11

Haze 12-8

HDOP 16-7

Heading 10-3, 10-12, 11-9

Helipad 18-2

Heliport 18-1

HFOM 16-7, 16-9

Hold 6-14

Home page 1-5

Hot spots 7-16, 7-17

HSI 9-33

HSI annunciation 6-17

## I

Icing 12-25

Ident 2-2, 3-15

IFR 1-18

ILS 18-1

ILS Approach 2-10, 6-16

ILS CDI Selection 6-18

Imminent obstacle impact 11-15

Imminent terrain impact 11-15

Insert after 4-9

Insert before 4-7

Intercom 2-14

Intersection 8-11, 9-18, 9-24, 13-4, 18-1

Invert colors 7-13

Invert flight plan 4-17, 4-24

## J

Jeppesen 19-9

Jeppesen database 19-9

## K

King autopilot 6-20

Knobs 1-2, 1-4

## L

Land data 9-4, 9-19

Lat/Lon 9-24

Foreword

Getting  
Started

Audio &  
Xpdr Ctr

Com/Nav

FPL

Direct-To

Proc

Charts

Wpt Info

Map

Traffic

Terrain

Weather

Nearest

Music

Utilities

System

Messages

Symbols

Appendix

Foreword	Legend 12-5
	Level 11-13, 11-16
Getting Started	Lighting 16-28
	Lightning 9-21, 9-24, 12-7, 12-21
Audio & Xpdr Ctrl	Limitations 10-5, 11-6, 12-11
	LNAV 6-17
	LNAV+V 6-17
Com/Nav	LNAV/VNAV Approach 6-3
	Load procedures in FPL 4-10
FPL	Localizer 3-15, 6-18
	Local offset 16-15
Direct-To	Locking screw 1-3
	Low alt 6-3
Proc	LP approach 6-17
	LPV Approach 6-3, 6-17
	L/VNAV 6-17
Charts	
	<b>M</b>
Wpt Info	Magnetic variation 16-22, 16-24
	Manual mag var 16-24
Map	Map 9-1
	Symbols 9-35
Traffic	Map controls 9-28
	Map data fields 9-21
Terrain	Map Detail 9-23
	Map menu 9-3
	Map orientation 9-13
Weather	Map overlay 9-4
	Map panning 9-25
Nearest	MAPR 6-3
	Map range 7-16, 9-13, 10-13, 11-10
Music	Map setup 9-10
	Map symbols 18-1, 18-4
Utilities	Map toolbar symbols 18-4
	Marker Hi Sense 2-11
	Mean Sea Level 11-1
System	Message 11-14, 11-19, 17-1
	METARs 12-7, 12-19
Messages	Mic selection 2-8
	Minimum runway length 1-12
Symbols	Miscellaneous symbols 18-5
	Missed Approach 6-14
Appendix	MOA 9-24, 18-5
	Model descriptions 1-1

Monitor 2-9
Monitoring frequency 3-14
Moving map 1-3
MSAS 16-10
MSL 11-7
Music 14-1, 14-3
Mute 14-6

## N

NACO 7-14
National Weather Service 12-9
Nav angle 16-22, 16-24
Navigation database 16-5, 19-9
Navigation map 7-16
Navigation source iii
Nav Radio 1-16
Nav range ring 9-15
NDB 8-13, 9-18, 9-24, 13-8, 18-1
Nearest airport 1-12, 1-15, 13-2, 16-16
Nearest airspace 13-10
Nearest ARTCC 13-13
Nearest frequency 3-6
Nearest FSS 13-15
Nearest intersection 13-4
Nearest NDB 13-8
Nearest User Wpt 13-9
Nearest VOR 13-6
Nearest waypoint 13-1
Nearest weather 13-17
Negative climb rate 11-14, 11-17
NEXRAD 9-7, 9-21, 12-7, 12-9
Limitations 12-11
NEXRAD Canada 12-12
Next airspace 9-26
Non-directional ownship 18-5
North up 9-13, 12-1
NOTAM 8-10
<b>O</b>
OBS 9-34, 19-5
Obstacle data 11-2, 11-7, 11-19, 16-4, 19-10
Obstacles 9-4, 9-16, 9-19, 10-7, 11-1, 11-2, 11-5, 11-6, 11-7, 11-8, 18-3

Obstructions 11-5, 11-6  
OCN 6-3  
Overview 1-3  
Ownship 16-27

## P

Page menus 9-10, 9-18, 9-20, 9-21  
Panning 9-25  
Parallel track 4-18, 18-5  
Parking area 18-2  
Part Sun 12-8  
Passenger address 2-9  
Photocell 16-28  
Pilot controls 1-4  
PIREP 12-27  
Point-to-Point 15-14, 15-22  
Power-up 7-13, 7-15, 7-17, 10-8, 11-1,  
11-8, 11-19, 19-9, 19-12  
Precipitation 12-11  
Premature descent alerting 11-16  
Preset 14-7  
Preview flight plan 4-25, 4-30  
Procedures 1-18, 6-1  
Procedure turn 6-13  
Product age 12-3, 12-7  
Product description 1-3  
Product Support v  
Proximate advisory 18-2  
Proximity advisory 10-3

## R

Radar 10-5, 10-7, 12-9, 12-11  
RAIM 15-11  
Rainy 12-8  
Range ring 9-15, 10-3, 10-13, 11-10  
Recent frequency 3-6  
Record of Revisions v  
Reduced required obstacle clearance  
11-15  
Reduced required terrain clearance 11-15  
Reflectivity 12-9, 12-10, 12-11  
Registration v  
Remote frequency control 3-13  
Remove FPL waypoint 4-9

Revisions vi  
RNAV 6-17  
Roll steering 6-13, 6-18  
Route options 4-23  
Runway 16-16  
Runway extension 9-18  
Runway length 1-12, 16-17  
Runways 8-7  
Runway surface 1-12, 16-17

## S

SafeTaxi 7-16, 7-17, 9-13, 9-18, 16-4,  
18-2  
SafeTaxi symbols 18-2  
SBAS 16-10  
Scale 9-15, 10-11  
SD card 1-3  
Secure Digital (SD) card 1-3, 1-4, 19-9  
Select approach 6-10  
Select arrival 6-7  
Select departure 6-4  
Self-test 1-7  
Serial numbers 14-8, 16-4  
Service Class 14-2  
Setup 16-14  
SIDs 1-18  
SIGMET 12-7, 12-16  
Snow 12-8, 12-11  
Software version 14-8, 16-3  
Special Use Airspace 13-1  
Speed 11-16  
Squawk code 2-4  
Squelch 3-2  
Standby 2-2  
STAR 6-7, 7-14  
STARs 1-18  
Start-up 1-6  
Status 16-7, 16-12  
Store flight plan 4-17  
Stormscope 9-8, 12-28  
Stuck microphone 3-12  
Sunny 12-8  
Sunrise/Sunset 15-12  
Support v

Foreword

Getting  
Started

Audio &  
Xpdr Ctr

Com/Nav

FPL

Direct-To

Proc

Charts

Wpt Info

Map

Traffic

Terrain

Weather

Nearest

Music

Utilities

System

Messages

Symbols

Appendix



## X

XM 12-1, 14-1

XM channel categories 14-4

XM radio activation 14-2

XM radio channel presets 14-7

XM radio channels 14-5

XM radio volume 14-6

XM Satellite Radio 14-1

XM troubleshooting 14-8

XM weather 12-1

## Z

Zulu 16-15

Foreword

Getting Started

Audio & Xpdr Ctr

Com/Nav

FPL

Direct-To

Proc

Charts

Wpt Info

Map

Traffic

Terrain

Weather

Nearest

Music

Utilities

System

Messages

Symbols

Appendix

Foreword

Getting Started

Audio & Xpdr Ctrl

Com/Nav

FPL

Direct-To

Proc

Charts

Wpt Info

Map

Traffic

Terrain

Weather

Nearest

Music

Utilities

System

Messages

Symbols

Appendix

*This page intentionally left blank*







© 2011 Garmin Corporation

Garmin International, Inc.  
1200 East 151<sup>st</sup> Street, Olathe, Kansas 66062, U.S.A.  
Tel. 913/397.8200 or 800/800.1020  
Fax 913/397.8282

Garmin AT, Inc.  
2345 Turner Rd., S.E., Salem, Oregon 97302, U.S.A.  
Tel. 503/581.8101 or 800/525.6726  
Fax. 503/364.2138

Garmin (Europe) Ltd.  
Liberty House, Bulls Copse Road, Hounslow Business Park,  
Southampton, SO40 9RB, U.K.  
Tel. +44 (0) 870 850 1243  
Fax +44 (0) 238 052 4004

Garmin Corporation  
No. 68, Jangshu 2<sup>nd</sup> Road, Shijr, Taipei County, Taiwan  
Tel. 886/2.2642.9199  
Fax 886/2.2642.9099

Garmin Singapore Pte. Ltd.  
46 East Coast road  
#05-06 Eastgate  
Singapore 428766  
Tel. (65) 63480378  
Fax (65) 63480278

[www.garmin.com](http://www.garmin.com)

Part Number 190-01007-03 Rev. B